

ASSA[®]

High Security Locks

ASSA
CLIQ[™]

2006 Product Catalog
Price Book and Technical Manual

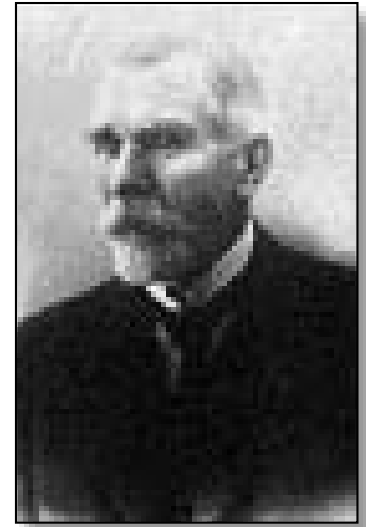

Table of Contents

	Page
History of ASSA, Incorporated.....	2
General Information.....	3
Standard Terms and Conditions.....	5
Keys and Keying	9
Architectural Specifications.....	16
Mortise Cylinders	17
High Security Mogul Cylinders.....	40
Rim Cylinders.....	49
Mortise & Rim Interchangeable Core Cylinders.....	57
Key-in-Knob/Lever Cylinders	64
Deadbolts	85
Auxiliary Locks	93
Padlocks.....	112
Profile Cylinders.....	121
Pin Kits, Tools & Accessories.....	131
Care & Maintenance for ASSA Cylinders & Keys.....	136
Parts Index.....	153

History of ASSA, Incorporated

ASSA was established in 1881 by the blacksmith August Stenman after buying a small hinge manufacturer in the town of Eskilstuna, Sweden. One day his wife embroidered a pillow slip with his name forwards and backwards – “August Stenman, Stenman August,” and so ASSA became the name of the new company. By 1939, ASSA had produced its first cylinder lock and delivered its first 5-pin cylinder master key system seven years later. In 1959, ASSA introduced its first registered key systems with key control. In 1981, ASSA celebrated its 100th anniversary as a company with the release of the ASSA Twin 6000 system, a new cylinder concept utilizing the dual locking mechanisms of today's ASSA cylinders.



ASSA, Inc. was originally opened in Naperville, IL as a marketing arm of ASSA AB in Sweden. Incorporated in 1984, ASSA, Inc. was a full line manufacturer of mortise locks, padlocks, auxiliary locks, and high security key systems. Under the direction of Wayne Wilkerson, who became president and CEO in 1989, ASSA, Inc. was transformed into the largest high security cylinder manufacturer in the United States.

Starting in 1992, ASSA, Inc. shifted its sales direction from independent dealer sales to institutional, industrial, and government sales. With the introduction of its new master keying capabilities they became the logical choice for institutions around the country. In 1996 alone, sales rose from under \$500,000.00 to over 8 million.

Some of the customers who made this possible are The World Bank, The United States Supreme Court, Boeing, AT&T, Baltimore Ravens Stadium, The University of New Hampshire, Prince George's County School District, Alexandria City Public Schools, Tucson Unified Schools, and numerous Schools and federal government facilities.

With the introduction of the Twin V-10 system in 1996, ASSA ushered in a new generation of lock technology offering patent protected, unique geographically exclusive keyways for ASSA authorized security centers and end users. The innovative Twin V-10 key design and cylinder helped to eliminate unauthorized duplicate keys and to maintain a key control system that is unmatched in the industry.

In 2000, ASSA introduced the Twin Exclusive, a patent-protected upgrade to the highly successful Twin 6000 series. Utilizing the same dual locking mechanism, the Twin Exclusive built on the original design and allowed one key to work both cylinders. That same year, ASSA, Inc. opened its doors to a new 5,000 square foot facility in New Haven, CT increasing its production capabilities with state of the art machinery and assembly equipment.

The high security key control system introduced by ASSA in 2003 is the Twin Pro, the most sophisticated key system being offered on the world market today. Worldwide keyways can be obtained through written agreement with ASSA for guaranteed exclusivity. The Twin Pro is not stocked by our traditional distribution outlets eliminating the possibility of the system being compromised. ASSA trains facilities to service these locks in-house or they can be serviced by an ASSA certified service center.

The Twin Maximum product line introduced in 2005 is set up to interface with the ASSA CLIQ system. Combining high security mechanical cylinders and keys with state of the art electronics, the ASSA CLIQ provides the user with a level of accountability and system control unmatched in the industry. A full audit trail with date and time stamp ensures the security of all or selected openings within the system while the keys can be used to operate standard mechanical cylinders as well. The innovative ASSA CLIQ is yet another example of why ASSA continues to be the world's leader in high security and patented key control solutions.

TWIN V-10, TWIN EXCLUSIVE, TWIN PRO, TWIN MAXIMUM, CLIQ

General Information

The ALPHA Twin 6000 System, The ALPHA Twin Exclusive System and The Twin Exclusive Cylinder Program

ASSA introduced the ALPHA System of key control programs to meet the security requirements of locksmiths, distributors and end users. The Twin Exclusive System is an extension of the Twin 6000 patent. The Twin Exclusive was introduced as an upgrade to the ASSA Twin 6000 program, introducing new patented keyblanks based on the Twin V-10 patent and new key profiles offering a low cost advantage for extending patent protection for the end user. The system consists of virtually the same programs as ALPHA and Twin V-10 Cylect. Briefly, the system consists of four programs:

TEL/Gamma	Locally exclusive keyways for locksmiths
TER/Beta	Regionally exclusive keyways for locksmiths
TED/Delta	Nationally exclusive keyways for distributors
TEE/Alpha	Regionally exclusive keyways for end-users, sold through normal channels of distribution.

The Twin V-10 Cylect Cylinder Program

The Twin V-10 was introduced as an upgrade to the ASSA Twin 6000 program, introducing new patented keyblanks and key profiles. The system consists of virtually the same programs as ALPHA:

C2L	Locally exclusive keyways for locksmiths
C2R	Regionally exclusive keyways for locksmiths
C2D	Nationally exclusive keyways for distributors
C2E	Regionally exclusive keyways for end-users, sold through normal channels of distribution.

Keyway Information

Each key control program in the ALPHA and Twin V-10 systems utilizes a standard cylinder plug profile (broaching). Various sidebar codes are used to create different keyways. Keyblanks produced after August 1988 are stamped with complete keyway code, e.g., 507-51. Please include keyway code and profile when ordering keys, keyblanks and cylinders, except SNS cylinders. (See Cylinder form, below).

The Twin Pro Cylinder Program

The Twin Pro program was introduced in 2003 as ASSA's highest level of controlled security in its delivery process. Twin Pro product is drop shipped only from the factory and is available to End Users and ASSA Certified Service Centers.

Twin Maximum Cylinder Program

The Twin Maximum program released in late 2005 has features that none of our other systems offer. The most advanced secure UL 437 Listed cylinder ever produced. A non UL version is offered for less secure doors. This system is designed to interface with the new CLIQ 3.0 access control cylinder with full audit trail features for the cylinders and keys.

CLIQ Cylinder Program

Version 3.0 is the most advanced access control system designed for a stand alone cylinder and key in the industry today. Offers time zoning, audit trail for cylinder and key. Interface with HID Prox systems in multiple formats. Offered in Twin Maximum only.

Cylinder Form

ASSA Twin locks and cylinders are available in three different forms:

COMP (Complete)	Keyed-different items include two cut keys per cylinder. Keyed-alike items normally include two cut keys per cylinder.
SUB (Sub-assembled)	Uncombined cylinder includes sidebar mechanism, but no tumbler pins, springs or keyblanks. Pin chamber closure strip, plug and screws provided.
SNS (Sub, No sidebar)	Uncombined cylinder without sidebar and sidebar springs. Includes sidepins, sidepin springs, standard tailpiece items and pin chamber closure.

When ordering ASSA Twin locks and cylinders, be sure to indicate CYLINDER FORM.

TWIN V-10, TWIN EXCLUSIVE, TWIN PRO, TWIN MAXIMUM, CLIQ

General Information

Red Core

ASSA provides temporary construction cores (red cores) for its interchangeable core cylinders upon request. Red cores are invoiced at \$77.00 and upon return to ASSA, credit will be issued for the full amount less a **50% handling fee**. Request for credit must be made in writing to ASSA Customer Service referencing the original invoice upon which the red cores appear. **KEYS ARE NOT INCLUDED IN THE PRICE OF THE RED CORE AND ARE NOT ELIGIBLE FOR RETURN.** All cut keys are invoiced at \$11.50 list each.

To order interchangeable core cylinders with temporary cores, specify cylinder model number, Cam, finish, by RED CORE, example, E6552ICR-1 x 626 x RED CORE. Cylinder will be charged at COMP price. To order red core separately, specify 70600ICR. Specify change keys as TWIN-KD-RED and control keys as TWIN-CT-RED.

Master Keying

ASSA Twin locks and cylinders may be master keyed to meet virtually any requirement. Contact the Key Records Department to discuss special needs. Master keying and bitting charges are shown on page 15.

FINISHES

Standard finishes are shown below. Antique brass (609) is available for deadbolts only.

ASSA BHMA Symbol	Equivalent U.S. Symbol	Euro Finish	Description
625	US 26	11	Bright Chrome
626	US 26D	13	Satin Chrome
605	US 3	20	Bright Brass
606	US 4	23	Satin Brass
609	US 5	47	Antique Brass
624	US 10B	46	Dark Oxidized
612	US 10	33	Satin Bronze

Special Function Cylinders

ASSA offers two special function cylinders most commonly used in the Detention market. One is a directional cylinder, which is operated bi-directionally by one key and in one direction only (clockwise or counterclockwise) by a subordinate key. This special function is accomplished by a modification to the cylinder plug. The necessity for this product is clear; to provide functionality in the system design. However, due to the physical modification of the plug when used in a master key system, the potential size of the master key system will be reduced.

The second special function is a limited rotation cylinder. This cylinder requires two modifications and will be used in conjunction with a directional function. One key will operate bi-directionally 360° and only one direction (clockwise or counter-clockwise) by a subordinate key stopping at a determined position prior to 180°. These modifications will greatly reduce the potential of a master key system.

It is essential to indicate all special function cylinders in the initial master key system design. Otherwise they may not be possible as part of the master key system.

Special function cylinders are offered in limited models and are indicated by a symbol:

† Prefixing the model number specifies available in special function.

How to order

Example	Model No.	Finish	Profile - Side Bar
Specify	V8551CW-14.....	626	95 – 888 (For Directional Cylinders)
Specify	V8551WL-14	626	95 – 888 (For Limited Rotation Cylinders)

TWIN V-10, TWIN EXCLUSIVE, TWIN PRO, TWIN MAXIMUM, CLIQ

Standard Terms & Conditions of Sale

1. General; Definitions

1.1 Entire Agreement

Unless otherwise agreed to in writing by ASSA, Inc. ("ASSA"), the terms and conditions contained herein constitute the entire agreement between the parties with respect to the subject matter hereof and supercede all prior communications and agreements. Acceptance by ASSA of Buyer's Order, or Buyer's acceptance of ASSA's proposal, is expressly limited to and conditioned upon Buyer's acceptance of these terms and conditions which may not be changed or waived except in writing signed by the parties. Any additional, inconsistent or different terms and conditions contained in Buyer's purchase order or other documentation are hereby expressly rejected.

1.2 Definitions

In these terms and conditions of sale: (i) "Buyer" means the person or entity who accepts a quotation of ASSA for the sale of the Products or whose Order for the Products is accepted by ASSA; (ii) "Conditions" means the standard terms and conditions of sale set out in this document and includes any special terms and conditions agreed to in writing between Buyer and ASSA; (iii) "Order" means an order for Products placed by Buyer with ASSA and accepted by ASSA; (iv) "Products" means the products ordered by Buyer and shall include all products, parts and accessories furnished to Buyer by ASSA.

2. Shipping; Delivery

2.1 Terms of Shipment

Unless otherwise agreed to in writing, all Products are shipped F.O.B. ASSA's location. ASSA reserves the right to deliver in installments.

2.2 Shipping Charges

Subject to Section 2.3, ASSA will pay all shipping charges in advance of shipment only for shipments of \$1,500.00 net U.S. or more with delivery to Buyer at a single location. Buyer will pay all shipping charges in advance of shipment for all shipments that are less than \$1,500.00 net U.S. or that require delivery to Buyer at more than a single location. Such charges will be added to Buyer's invoice.

2.3 Choice of Carrier; Route

Unless otherwise requested on Buyer's Order, ASSA will ship by carrier and route of its choice to any freight service point within the continental United States. If Buyer requests a carrier or route on its Order, ASSA will deliver in accordance with such request and Buyer will

pay the entire amount of all shipping charges in advance of shipment.

3. Title and Risk of Loss

Subject to Section 5.3, title to and risk of loss of each Product purchased by Buyer shall pass to Buyer and delivery shall be deemed to be complete upon transfer of the Products to a carrier for shipment at ASSA's location or the Products otherwise leave the possession or control of ASSA. This Section 3 shall survive any expiration or termination hereof.

4. Orders

4.1 Acceptance

ASSA reserves the right to refuse Orders and is not bound to honor any Order unless and until such Order has been accepted by ASSA. ASSA may refuse an Order by delivering notice, orally or in writing, of such refusal to Buyer within ten (10) days of ASSA's receipt of such Order.

4.2 End User Security Authorization Procedures.

To insure proper control of End User restricted products, ASSA requires that the End User complete a Delivery of Controlled ASSA Components for End Users Form. The form will indicate where and to whom their restricted product will ship upon leaving the ASSA factory. Restricted product is defined as high security keyblanks, cut keys, sidebars, sub-assembled cylinders (SUB), complete and master keyed cylinders (COMP), and key charts. All orders involving an End User restricted product must be signed by the proper **authorized personnel on file at ASSA**. This is critical in order to maintain the integrity of the End User's key system. ASSA will honor the specific, written instructions of the **authorized personnel** for the shipping and handling of each purchase order. Such instructions must be included with each order. A copy of the End User Controlled Product Delivery Form is available by contacting ASSA customer service or the local ASSA sales representative. Please note the option of blanket authorization on the form. If the distributor chooses this option, it is the distributor's responsibility to keep the authorization current and on file. ASSA does not maintain any files of blanket authorizations. **A copy of a CURRENT authorization form signed by an authorized signatory must accompany every Distributor purchase order containing End User restricted product sent to ASSA whether the product is shipping to the End User location or not.** All orders not having this form will be suspended indefinitely or until such form is produced. In the event that any change occurs in the authorization of any End User personnel,

TWIN V-10, TWIN EXCLUSIVE, TWIN PRO, TWIN MAXIMUM, CLIQ

Standard Terms & Conditions of Sale

ASSA will require that official written notification be made to ASSA by the End User on their letterhead before additional orders will be released.

4.3 Order Identification

All packages are identified as to contents and assigned an Order number. The Order number also appears on Order acknowledgements, packing slips, freight bills and invoices.

4.4 Packing

Unless otherwise specified, all locks and cylinders are packed individually.

4.5 Changes and Cancellations

No Order that has been accepted by ASSA may be changed or cancelled by Buyer unless ASSA agrees to such change or cancellation in writing. Buyer will indemnify ASSA in full against all loss (including loss of revenue), costs (including the cost of all labor and materials used), damages, charges, and expenses incurred by ASSA. Changes will result in a delay in the scheduled ship date. Additions to Orders will be entered as a separate Order. Special Orders for non-cataloged items and any Orders that are within sixty (60) days of the original shipment date are not subject to cancellation.

4.6 Return Products Authorization

Return Products will not be accepted unless authorized in advance in writing by ASSA. Used or damaged items will not be accepted. Products returned to ASSA for credit must be received by ASSA within sixty (60) days of initial shipment and must be in saleable condition. The value of goods returned is subject to appraisal as to physical condition. Returns will only be accepted for credit invoicing and a minimum handling charge of 25% will be debited. All returned Products must be shipped F.O.B. ASSA's location, freight prepaid. Credit will not be issued for missing parts. Requirement for returns are: the ordering distributor must request a Return Goods Authorization (RGA) in writing through the same process that purchase orders are done. Each Item being returned must have full item description with the original purchase order number that the item was ordered under or the ASSA order number that the item was shipped under which can be found on the Item box label marked REF#.

Return Goods Authorization is then approved or denied through ASSA's established internal process. In either case the requesting distributor is notified by ASSA in writing. If approved, distributor will receive in

writing a Return Goods Authorization Number and instructions for marking containers for authorized items being returned.

Once received, Items are physically inspected and checked against the RGA. Information will then be forwarded to the credit department where credit invoicing will be applied.

Any Items sent by distributor that are not listed as part of the authorized return will not be credited and ASSA will not be responsible for return of these items to the shipper.

ASSA will not accept Keyed Cylinder returns.

5. Price; Taxes; Payment

5.1 Price

Unless otherwise agreed to in writing, the price for the Products shall be ASSA's prevailing price at the time the Order is accepted by ASSA or any other price quoted in writing to Buyer. ASSA's price lists are for general information only and do not constitute a binding, open offer by ASSA for the sale of Products. ASSA reserves the right to modify its standard prices at any time without notice; prices for some Products may change frequently due to market fluctuations.

5.2 Taxes

Buyer shall pay the full amount of any tax or other charge now or hereafter imposed by law upon, with respect to, or measured by the sale, shipment or price of any Product sold hereunder, including without limitation any handling charges; federal, state, or local sales, use, excise, value added, gross receipts or other like taxes; customs duties; and any insurance desired by Buyer. If Buyer is exempt from an applicable tax or duty, then Buyer must provide ASSA with a valid exemption certificate before shipment of Products. Foreign shipments placed with ASSA may require additional charges for documentation and overseas packaging. Such charges will be identified on ASSA's invoices. This Section 5.2 shall survive any expiration or termination hereof.

5.3 Payment

Unless otherwise agreed to in writing, payment is due thirty (30) days from the date of the invoice. If payments are not made when due, Buyer will pay, in addition to the overdue payment, a late charge equal to the lesser of 1.5% per month or the highest applicable rate allowed by law on such overdue amounts. Overdue accounts will be assigned to the credit department for all transactions. Once an

TWIN V-10, TWIN EXCLUSIVE, TWIN PRO, TWIN MAXIMUM, CLIQ

Standard Terms & Conditions of Sale

account has been assigned to the credit department, no Order may be taken, entered or shipped without approval from the credit manager. Buyer hereby grants ASSA a purchase money security interest in each Product and agrees to cooperate with ASSA in protecting such interest.

6. Insurance

6.1 Insurance Coverage

Buyer shall procure and maintain, at its expense, the following types of insurance from an insurer acceptable to ASSA, in the amounts at least equal to those specified below, with deductibles not in excess of \$100.00. ASSA shall not be required to supply Products to Buyer at any time that the insurance coverage provided for herein is not in full force and effect.

6.2 Certificates

Buyer shall, within fifteen (15) days from the date hereof, furnish ASSA with a certificate of insurance issued by the insurance company or companies issuing the insurance policies required hereby. Such certificates shall provide that written notices shall be given to ASSA at its address specified herein at least forty-five (45) days prior to any cancellation or change in any such policy.

7. Warranties and Limitation of Liability

7.1 Warranty

ASSA represents and warrants the Products against defective material and faulty workmanship for a period of one year after the date of delivery [and warrants the finish to meet quality standards at the time of delivery]. This warranty expressly does not apply to faulty product operation due to: (a) improper installation; (b) the use of any keys, cylinder pins or other accessories not expressly approved by ASSA; or (c) failure to provide reasonable maintenance.

7.2 Limitation of Liability

ASSA's liability under this warranty shall be limited solely to the repair or replacement of the Products, or parts thereof, or refund to the Buyer of the purchase price thereof. ASSA shall not be responsible for any defect or non-conformity in the Products that: (a) is created after the time of delivery; (b) results from Products for which materials, specifications or designs were provided by Buyer; or (c) results from modifications to the Products by Buyer or others. **IN NO EVENT SHALL ASSA BE LIABLE FOR SPECIAL, INDIRECT, INCIDENTAL, OR CONSEQUENTIAL DAMAGES, WHETHER IN CONTRACT, WARRANTY, NEGLIGENCE, TORT, STRICT LIABILITY, OR OTHERWISE** including but not limited to loss of profits or revenue,

loss of use of the Products, delays, or claims of customers of the Buyer or other third parties for such other damages. ASSA's liability on all claims, whether in contract, warranty, negligence, tort, strict liability or otherwise for any loss or damage arising out of, or connected with an Order or the performance or breach thereof, or from the design, manufacture, sale, or delivery shall in no case exceed the purchase price of the Product.

7.3 No Other Warranties

EXCEPT AS EXPRESSLY SET FORTH IN SECTION 7.1, ASSA MAKES NO OTHER REPRESENTATIONS OR WARRANTIES, EXPRESS OR IMPLIED, AT LAW OR IN EQUITY, WITH RESPECT TO THE PRODUCTS OR THEIR CHARACTERISTICS, QUALITY OR PERFORMANCE, INCLUDING, WITHOUT LIMITATION, THE IMPLIED WARRANTIES OF MERCHANTABILITY, FITNESS FOR A PARTICULAR PURPOSE, OR NON-INFRINGEMENT OF ANY INTELLECTUAL PROPERTY RIGHTS OF THIRD PARTIES AND ANY SUCH REPRESENTATIONS AND WARRANTIES ARE HEREBY EXPRESSLY DISCLAIMED.

8. Claims

Buyer must notify ASSA of any claim [for adjustment] in writing at ASSA's address specified herein within thirty (30) days after the date of the invoice in question. Buyer must notify ASSA of any claim for shortages or incorrectly filled Orders in writing within ten (10) days after receipt of shipment. Under no circumstances will ASSA be responsible for any charges for labor or material incurred by others without the prior written consent of ASSA.

9. Indemnity

9.1 Personal Injury and Property Damage

Buyer shall indemnify ASSA and hold ASSA harmless against all claims, liability, loss or other damages (including ASSA's legal expenses) to all persons for injury of any nature, including, without limitation, sickness, and/or death, and for property damage caused by any Product or part thereof after the time of delivery of such Product or after such Product otherwise leaves the possession or control of ASSA.

9.2 Compliance with Law

Buyer agrees: (a) to fully comply with all applicable federal, state and local laws, rules, regulations and guidelines, including without limitation, all applicable regulations and guidelines promulgated, from time to time, by Federal and state environmental and transportation officials, and (b) to indemnify and hold harmless ASSA from and against all claims, liability, loss

TWIN V-10, TWIN EXCLUSIVE, TWIN PRO, TWIN MAXIMUM, CLIQ

Standard Terms & Conditions of Sale

or other damages (including ASSA's legal expenses) resulting in any way from non-compliance therewith.

9.3 Survival

This Section 9 shall survive any expiration or other termination hereof.

10. Trademarks and Other Markings

Buyer shall remove any and all of ASSA's trademarks, labels, distinctive markings, and designs which may appear on any Product or on the packaging material therefore at the time of delivery of such Product and to refrain from making any use of such trademarks, labels, distinctive markings and designs.

11. Miscellaneous

11.1 Governing Law

The validity and interpretation of these terms and conditions of sale shall be governed by the laws of the State of Connecticut without regard to its principles of conflicts of law.

11.2 Force Majeure

ASSA shall not be liable for its failure to perform hereunder due to any contingency beyond its reasonable control, including without limitation acts of God, fires, floods, wars, sabotage, accidents, labor disputes or shortages, governmental laws, ordinances, rules and regulations, whether valid or invalid (including, but not limited to, priorities, requisitions, allocations, and price adjustment restrictions), inability to obtain material, equipment or transportation, and any other similar contingency. In the event of delay due to any such cause, the date of delivery will be postponed by such length of time as may be reasonably necessary to compensate for the delay.

11.3. No Assignment

These terms and conditions of sale are not assignable or transferable by Buyer, in whole or in part, without the prior written consent of ASSA.

11.4 Modification

No modification or waiver of these terms and conditions of sale shall be effective unless made in a writing signed by ASSA. No course of action shall be deemed to modify these terms and conditions of sale.

11.5 Severability.

Whenever possible each provision and term of these terms and conditions of sale will be interpreted in a manner to be effective and valid but if any provision or term hereof is held to be prohibited by law or invalid,

then such provision or term will be ineffective only to the extent of such prohibition or invalidity, without invalidating or affecting in any manner whatsoever the remainder of such provision or term or the remaining provisions or terms hereof.

COPYRIGHTS, PATENTS

All products shown in ASSA catalogs, brochures and price lists are either patented, copyrighted or registered by ASSA.

*Prices, products, equipment, finishes, models, specifications and availability are subject to change without notice.

All notices or other correspondence to ASSA may be made at the following address:

ASSA, Inc.
110 Sargent Drive
New Haven, CT 06511
(800) 235-7482
(800) 892-3256 fax

TWIN V-10, TWIN EXCLUSIVE, TWIN PRO, TWIN MAXIMUM, CLIQ

Keys and Keying

All ASSA keys are manufactured from the highest quality nickel silver material. The key's rounded back facilitates smooth operation and minimizes wear. The large key bow simplifies identification and use by manually impaired people. Keys can be provided with various options of tactile identification upon request. Available in several profiles or broaches, ASSA high security keys all feature a unique side milling on the lower portion of the key blade and are precut at the ASSA factory. Each side milling represents a key section that is factory controlled on a geographic basis providing an unmatched level of patented key control.



Benefits

- Two sets of key cuts designed to operate independent locking mechanisms
- Innovative key design protected by U.S. and international patents
- Patented key control offers the ultimate in high security
- Top cuts can be generated on standard, quality code cutting equipment
- ASSA's generous keying capabilities allow over 160,000 change keys under a single master key

Warranty

- ASSA guarantees that if a key should break under normal usage, ASSA will replace it at no charge plus any reasonable service charge
- ASSA guarantees that no other top level master key for any other ASSA factory generated master key system will operate as a top level key in an end-user's system for a specified geographic territory
- ASSA guarantees its patented systems against unauthorized key duplication

Certification

- Twin Exclusive, Twin V-10, Twin Pro and Twin Maximum keys listed under U.S. Patent numbers 5,067,335 and 5,640,865

Technical Information

- High quality nickel silver material
- Key combination is read from tip to bow
- No. 1 cut is deepest, No. 9 is shallowest
- Maximum adjacent cut is 5 (example: 1-6 is acceptable, 1-7, 8 or 9 is not)
- Cut depth is measured as root depth from back of key to bottom of cut

Special stamping and custom coining available

TWIN V-10, TWIN EXCLUSIVE, TWIN PRO, TWIN MAXIMUM, CLIQ

Keys and Keying

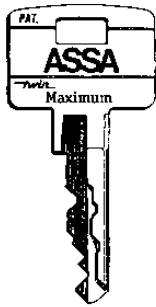

Twin Maximum



Twin Pro

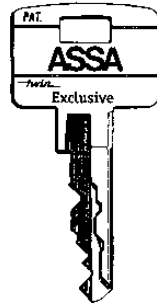

Twin Exclusive

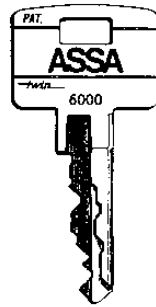

Twin 6000

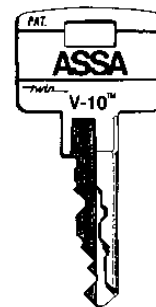

Twin V-10

ASSA Cut Keys

Item No.	Description	Price
TMAX-KD	Twin Maximum Cut Key	11.50 ea
TMAX-MK	Twin Maximum Cut Keys, In a Master Key System	11.50 ea
TPRO-KD	Twin Pro Cut Keys KD/KA	11.50 ea
TPRO-MK	Twin Pro Cut Keys, In a Master Key System	11.50 ea
Twin-KD	Twin Exclusive/6000 Classic (Specify Profile) Cut Keys KD/KA	11.50 ea
Twin-MK	Twin Exclusive/6000 Classic (Specify Profile) Cut Keys, In a Master Key System	11.50 ea
V-10-KD	Twin V-10 Cut Keys KD/KA	11.50 ea
V-10-MK	Twin V-10 Cut Keys, In a Master Key System	11.50 ea

ASSA Key Blanks

Item No.	Description	Price
359644	Twin Maximum Key Blanks Qty. 100/box	4.50 ea
816313	Twin Pro Keyblanks/Sidebar code (specify sidebar code) Qty. 100/box	4.50 ea
867091	Twin 6000 Key Blanks (specify sidebar code and profile) Qty. 100/box	4.50 ea
E867091	Twin Exclusive Key blanks/Sidebar code (specify sidebar code) Qty 100/box	4.50 ea
250694	Twin V-10 Keyblanks/Sidebar code (specify sidebar code) Qty 100/box	4.50 ea
969030	White Code Tags	2.50 ea

ASSA Coined Key Blanks

Item No.	Description	Price
	Initial die charge	400.00/Net
868996	500 minimum key blank quantity each order (Specify profile and side code)	4.50 ea

TWIN V-10, TWIN EXCLUSIVE, TWIN PRO, TWIN MAXIMUM, CLIQ

Keys and Keying



868062
600 Series

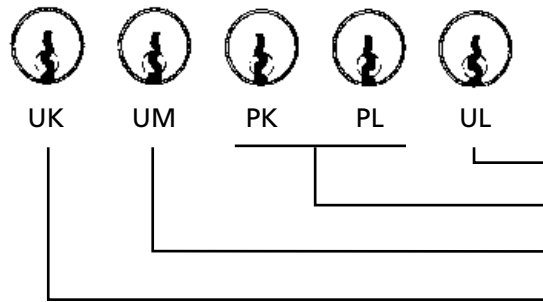

- Open: Master-Key systems
- Restricted: All
- Open: Master-Key Systems
- Open: Keyed Alike/Keyed Different

600 Series Cut Keys & Key Blanks

Item No.	Description	Price
600-KD	Cut Keys KD / KA	11.50 ea
600-MK	Cut Keys, In a Master Key System	11.50 ea
868062	Key blanks/ Specify profile (UK, UL, UM, PK, PL)	4.50 ea

500 Series Key Blanks

Item No.	Description	Price
462000	Key blanks/ specify profile	5.50 ea

700 Series Key Blanks

Item No.	Description	Price
462001	Key blanks/ specify profile	5.50 ea

Cut Key Set

Item No.	Description	Price
CKS-1	V-10 Cut Key Set	39.00 ea
ECKS	Twin Exclusive Cut Key Set	39.00 ea
TPCKS	Twin Pro Cut Key Set	39.00 ea
TMCKS	Twin Maximum Cut Key Set	39.00 ea

TWIN V-10, TWIN EXCLUSIVE, TWIN PRO, TWIN MAXIMUM, CLIQ

ASSA CLIQ™

ASSA CLIQ™ intelligent locking systems gives control over all keys, which can easily be upgraded and can be tailor-made to suit any needs. Since every key has its own identity, it becomes the “personal property” of the key holder. CLIQ makes intelligent, flexible and high security lock systems possible. The key’s mechanical design creates the basic foundation made up of different security zones in the same way as in mechanical lock systems. The electronic programming of the keys gives authorization to individuals or to group of individuals. CLIQ technology’s basic idea is the creation of an intelligent security system. That means a lock system that retains a high level of security despite upgrading, alterations or expansion. Even after many years of use by a continual flow of new tenants, new employees or changes occurring in the workplace, the level of security will remain the same.



Benefits

- Based on Twin Maximum Technology
- High and Medium Security Levels
- Extreme Master Keying Capacity
- Concealed Keying
- Wide Range of Retrofit Cylinder Shapes
- Possible to Add CLIQ Functionality

Warranty

- Battery Life 2 Years or 20K Openings
- Lifetime on Key Breakage

Certification

- Patented Key Control
- UL Listed

Technical Information

- Power Supply is Provided by the Key
- Data Transfer 64 Bit and Higher

TWIN V-10, TWIN EXCLUSIVE, TWIN PRO, TWIN MAXIMUM, CLIQ

CLIQ™ Keys and Software

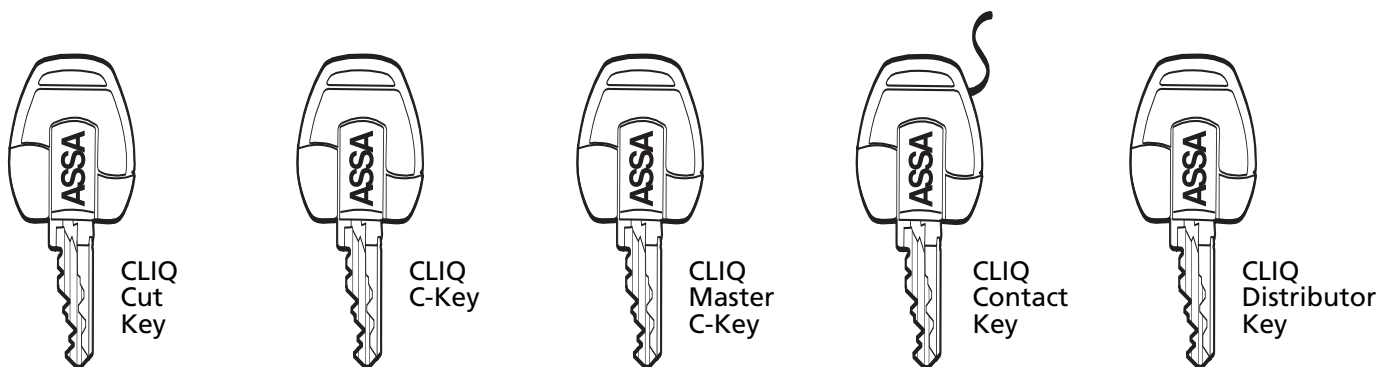

ASSA CLIQ™ Keys

Item No.	Description	Price
CLIQ-KD	CLIQ Cut Key	65.00
CLIQ-CK	CLIQ C-Key	90.00
CLIQ-MCK	CLIQ Master C-Key	125.00
CLIQ-CON	CLIQ Contact Key	125.00
CLIQ-DIS	CLIQ Distributor Key	125.00

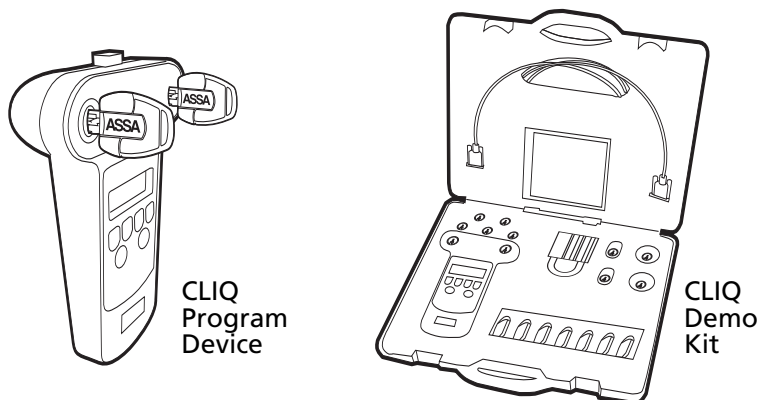

CLIQ™ Programming Unit & Software

Item No.	Description	Price
CLIQ-END	Program Device with Software (For Dealer/End-user Use to Manage CLIQ System)	1,950.00
CLIQ-DEA	Program Device with Software (For Distributor/Dealer Use to Manage Multiple CLIQ Systems)	1,950.00
CLIQ-SDK	Sales Demo Kit (For Sales People to demonstrate program device software, padlock, deadbolt, mortise, and key-in-knob cylinder, operating keys, 1 control key, 1 master key, 1 C-key, 1 mortise cutaway cylinder)	5,750.00

TWIN V-10, TWIN EXCLUSIVE, TWIN PRO, TWIN MAXIMUM, CLIQ

Keys and Keying

Master Key Order Procedure

Master Key system orders for ASSA products are processed using desktop computer systems. Part of our processing software allows us to import the customer order data when it is submitted to us in the compatible format described below on a diskette or via E-mail.

Excel File Format

The layout of an Excel file which we can import is shown below. The first line in the file should number the fields 1 through 9, the file should not contain headers or formulas.

Field	Content	Character limit
1	Item #	4
2	Cyl. Quan.	4
3	Cyl/Cam PN	12
4	Finish	5
5	Cam	3 (do not use, include cam with cylinder part #)
6	Keyset	12
7	Key Quan.	4
8	Door #	12
9	Comments	20
10	Spl. Key stamp	12 (For stamping other than DHI or SKCS standard)

The import of an Excel format file offers a special feature regarding systems which incorporate a ENG key. If a particular item is to be operated by the ENG key in addition to the other key indicated by the keyset you can indicate this to our software by adding a suffix of "-E" to the keyset. In such a case AAI would become AAI-E if it should be operated by the ENG key. This specification option is not available if the imported file is supplied in ASCII format.

In order to ensure that correct master keying information is received and accurate records are maintained, ASSA has designed a Sample Order Template. The following is an example of a completed sample order log that must accompany each master key order submitted to ASSA. When filling out the key quantity column, unless otherwise requested, two keys will be supplied per cylinder with all master keyed orders.

The form is available by contacting your ASSA representative, ASSA Customer Service, or by logging onto the ASSA website www.assalock.com. If a computer or the Excel program is not available to you, contact your ASSA representative for assistance in getting the form completed. The completed form is then e-mailed to ASSA key records email address adautaj@assalock.com. Master key purchase orders can be faxed to 800-892-3256 or mailed to ASSA Inc., 110 Sargent Dr. New Haven, CT. 06511.

TWIN V-10, TWIN EXCLUSIVE, TWIN PRO, TWIN MAXIMUM, CLIQ

Keys and Keying

The ASSA Key Records Department carefully designs and records master key systems in compliance with customer requirements and ASSA security policy. System documents are thoroughly detailed, produced, and professionally presented, and should be considered valuable and confidential. Key Records information and service is available as follows:

Factory Keyed Cylinders

Cylinders pinned by the factory are supplied "Keyed Different" or if so specified as one of the following options:

- Master Keyed (Bittings provided at No Charge when requested with the order)\$11.00 per cylinder
- Keyed Alike/Keyed DifferentNo Charge
- Single Keyed Different (Part of MK System).....11.00 per cylinder

Factory Generated Master Key Systems

ASSA will provide new master key systems for pinning by the locksmith in accordance with prices below:

Quantity	ON PAPER		ON DISK	
	Bittings Only	Bittings & Pinnings	Bittings Only	Bittings & Pinnings
1-50.....	140.50.....	422.50.....	68.00.....	140.50
51-200.....	211.00.....	562.50.....	68.00.....	280.50
201-1000.....	280.50.....	703.00.....	68.00.....	351.50
1001-5000.....	351.50.....	1,125.00.....	68.00.....	562.50
5001-10000.....	444.00.....	1,688.00.....	68.00.....	844.50
10001-25000.....	622.00.....	2,250.50.....	136.50.....	1,125.00

Over 25,000 or more contact Customer Service for quote.

These prices are for a hierarchical Master Key System with no Cross-keying of selective keys. For special requirements, contact Customer Service or Key Records Department.

Systems prior to 1996, contact Customer Service for quote.

Disks will be provided in flat ASCII text only.

Other Key Charges

System Copy Charge (copy of existing system – MBCC) (\$57.00 net min.)2.25 per page

System Expansions: Priced as above

All Other Systems Charges Billed per Request

Standard KD/KA key stamping includes keyway designation code.

Standard MK system stamping includes and key symbol.

Do Not Duplicate and other special stamping requirements will be priced at \$2.25 per stamp.

Factory does not recommend cross-keying and will not warranty any cross-keyed cylinders.

TWIN V-10, TWIN EXCLUSIVE, TWIN PRO, TWIN MAXIMUM, CLIQ

Architectural Specification

High Security Key System

General requirements:

1. Provide a high security key system capable of integrating various type of lock cylinders; mogul, builder hardware, and auxiliary locks, into a patented, geographically restricted, factory master keyed system to allow control over the entire facility.
 - a. Include detention mogul cylinders, builders hardware cylinders, auxiliary locks, and padlocks keyed into one compatible system for locks specified in this section and those specified in related sections.
 - b. Proprietary Keyway: Provide written guarantee from the manufacturer that the Keyway used on this project is for the exclusive use of the Owner on a regional basis..
2. Master Keying
 - a. Provide level 3 grandmaster key system. As defined in (DHI) "Keying Systems and Nomenclature".
 - b. Provide factory established key system and keying of cylinders.
 - 1). Arrange for manufacturer to maintain permanent key identification and registration records.
3. Keys
 - a. Replacement Keys: available only from the manufacturer upon written authorization from the Owner.
 - b. Stamping of Keys: Stamp keys with an identification code in accordance with "Keying Procedures, Systems, and Nomenclature" published by DHI.
 - c. Quantity:
 - 1) Change keys:
 - a. Allow for four (4) change keys per lock cylinder.
 - b. Furnish a minimum of six (6) keys per key set, remaining keys as instructed by the Owner.
 - 2) Master level keys:
 - a. Furnish a minimum of ten (10) of each masterkey and six (6) of each master level key above the grandmaster.
 - d. Material: Nickel silver alloy.
 - e. Minimum size: 1" x 3" long 1/8 "thick,
4. Cylinders
 - a. Marking of Cylinders: Using a black indelible ink pen, mark body of cylinders with an identification code in accordance with "Keying Procedures, Systems, and Nomenclature" published by DHI.
 - b. Standard compliance
 - 1) Listed under UL 437.
 - 2) ANSI/BHMA A156.30 standard for High Security Cylinders.
 - 3) ASTM 1577 6.6 standards for Correctional Cylinders
5. Temporary Construction Security
 - a. Provide temporary construction cylinders and keys for exterior doors, automatically locking doors where security is required, and doors to rooms used for storage.
 - 1) Temporary cylinders and keys remain the property of the contractor.
 - b. Provide temporary blank strike plates for lock bolt receivers to prevent automatic locking of doors where temporary construction cylinders are not used and security at the door during construction is not required..

TWIN V-10, TWIN EXCLUSIVE, TWIN PRO, TWIN MAXIMUM, CLIQ

Mortise Cylinders

ASSA mortise cylinders are designed to replace several original manufacturers' cylinders in their locksets offering the highest level of security available on the market today. Made to standard U.S. dimensions, these rugged cylinders are available in a variety of finishes and lengths and stand up to even the heaviest abuse. All ASSA mortise cylinders are listed under U.L. 437, a set of tests for determining the cylinder's physical resistance against various forms of attack.

ASSA mortise cylinders will improve the security of standard mortise locksets by Arrow, Corbin/Russwin, Sargent, Schlage, Yale and many other manufacturers.

**Benefits:**

- Drill resistant cylinder housing and plug
- Case-hardened steel inserts and stainless steel pins
- Two independent locking mechanisms to ensure optimum pick resistance
- Inactive "false" grooves on side pins designed to catch picking tools
- Extremely close tolerances
- Can be easily rekeyed in the field
- With the purchase of one inexpensive kit, 1-1/8" mortise cylinder is easily converted to rim cylinder

Warranty:

- ASSA guarantees its cylinders against defective workmanship or wear resulting from defects for life

Certification:

- All ASSA Twin Series Mortise cylinders are U.L. 437 listed as well as ASTM F 1577 6.6 listed for standard test methods for detention Locks.

Technical Information:

- Available in cylinder lengths 1-1/8" through 2" in 1/8" increments
- Available with limited rotation and/or unidirectional features
- 13 cam options available
- Cylinder housing and plug are made of high quality brass
- Stainless steel top pins
- Bottom pins and master pins are nickel silver

Finishes:

<u>BHMA Symbol</u>	<u>U.S. Symbol</u>	<u>Euro Finishes</u>	<u>Description</u>
625	US 26	11	Bright Chrome
626	US 26D	13	Satin Chrome
605	US 3	20	Bright Brass
606	US 4	23	Satin Brass
612	US 10	33	Satin Bronze
624	US 10B	46	Dark Oxidized Bronze

TWIN V-10, TWIN EXCLUSIVE, TWIN PRO, TWIN MAXIMUM, CLIQ

Mortise Cylinders Ordering Information

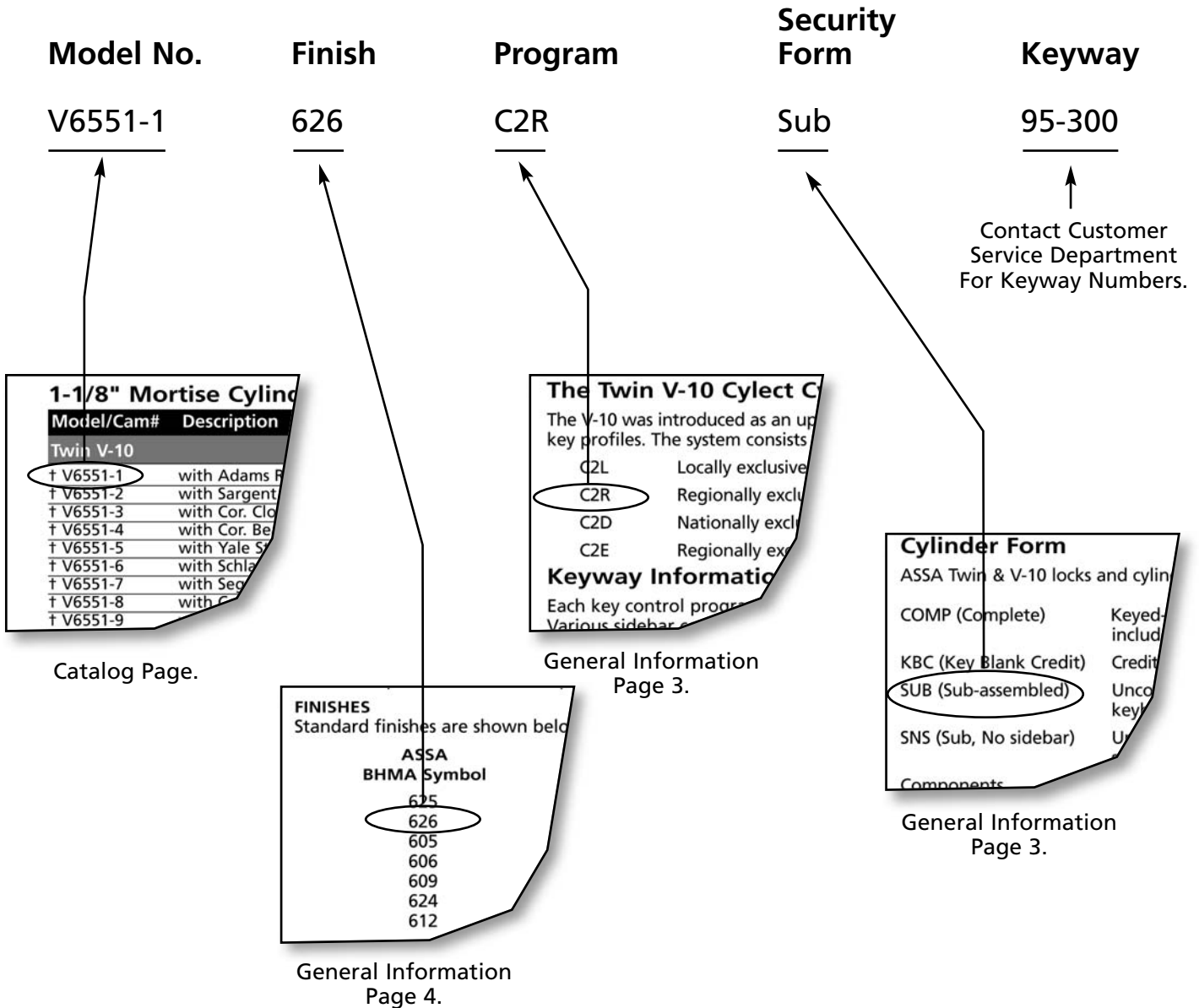

How To Order Twin V-10 & Twin Exclusive Mortise Cylinders:

Specify	Model No.	Finish	Security Program	Form	Keyway
Example:	V6551-1	626	C2R	Sub	95-300

How To Order Twin Pro & Twin Maximum Mortise Cylinders:

Specify	Model No.	Finish	Form	Keyway
Example:	6151-1	605	Comp	0P4-200

TWIN V-10, TWIN EXCLUSIVE, TWIN PRO, TWIN MAXIMUM, CLIQ

Mortise Cylinders Exploded View

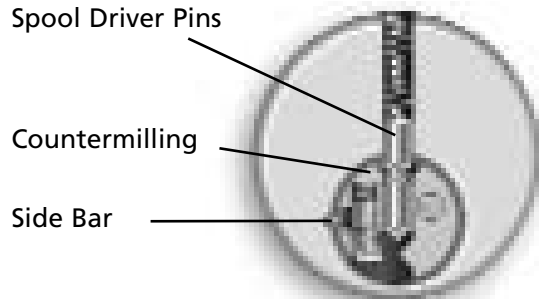

No key inserted:

- Standard pins block the shear line
- Side bar rests in groove of cylinder housing, blocking movement of plug

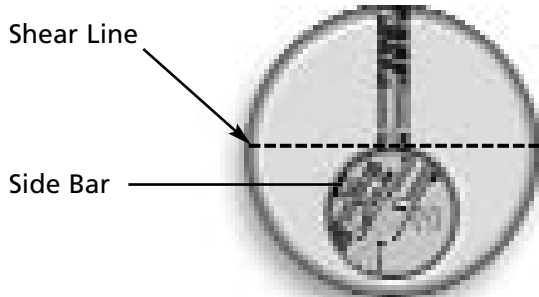

Correct key inserted:

- System code of key lifts standard pins to shear line
- Side bar code of key lifts side pins into a position where the side bar can be received. Side bar then recesses into plug as key is turned

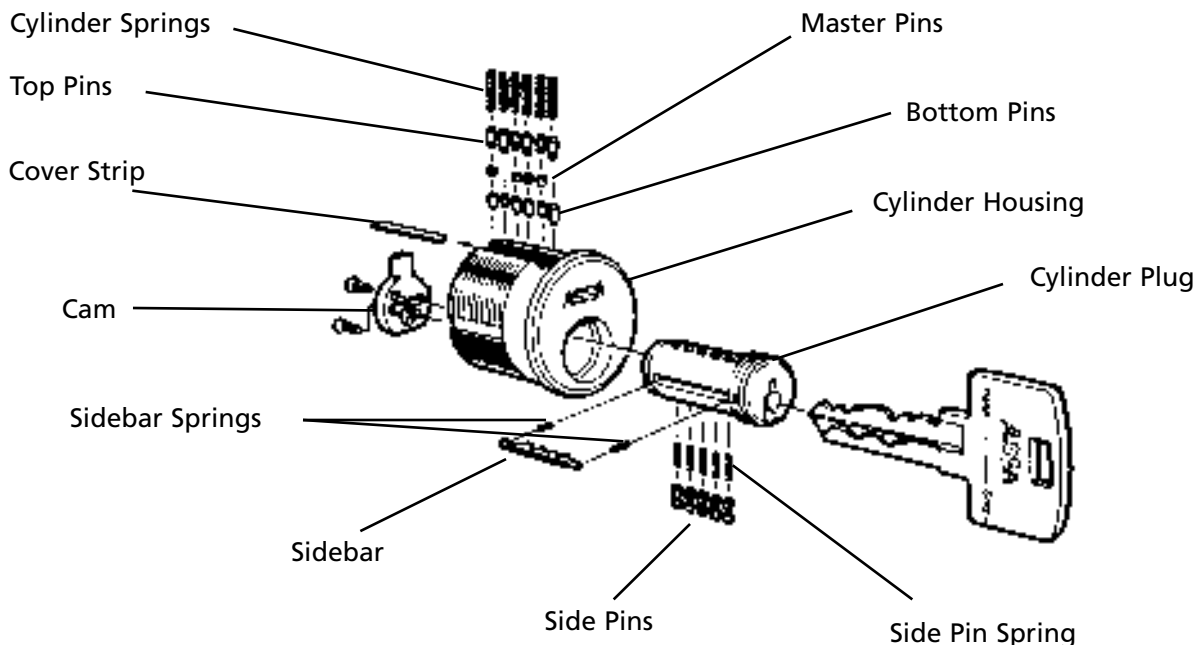
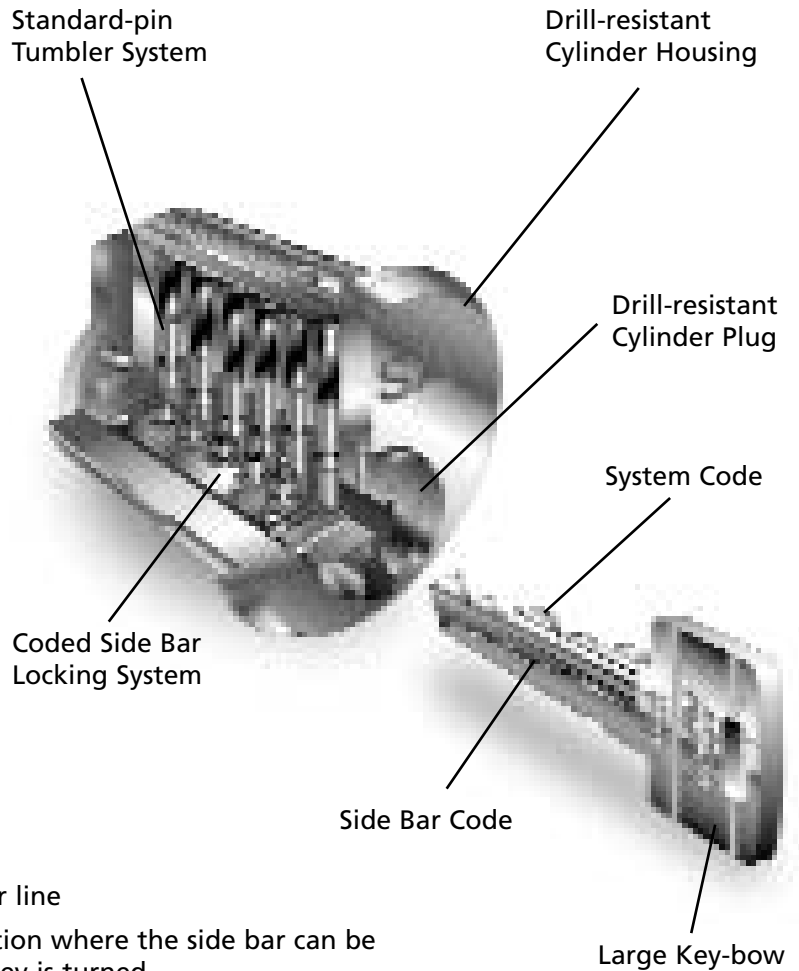

TWIN V-10, TWIN EXCLUSIVE, TWIN PRO, TWIN MAXIMUM, CLIQ

Mortise Cylinders

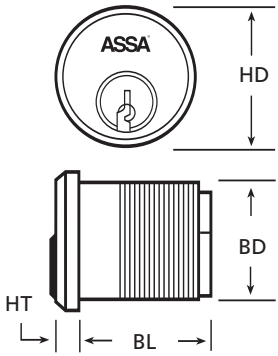

Mortise Cylinder Key:
 HD – Head Diameter
 HT – Head Thickness
 BL – Body Length
 (Includes Cam)
 BD – Body Diameter

Available Cams

Cam Key:
 R-A – Head Radius • R-B – Overall Radius

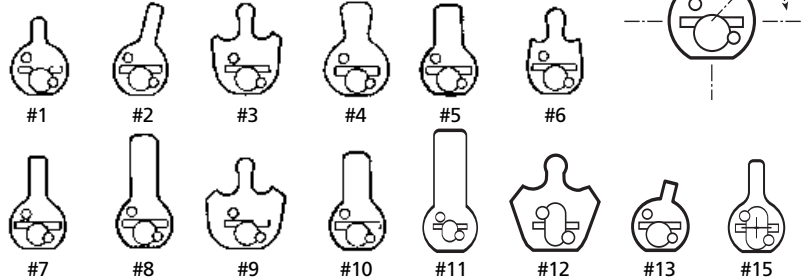

1-1/8" Mortise Cylinder

Model/Cam#	Description	HD	HT	BL	BD	R-A	R-B	Comp	Sub	SNS
Twin V-10										
† V6551-1	with Adams Rite Cam	1.366	0.138	1.125	1.157	0.118	0.555	82.00	72.50	65.50
† V6551-2	with Sargent Cam	1.366	0.138	1.125	1.157	N/A	0.709	82.00	72.50	65.50
† V6551-3	with Cor. Clover Leaf Cam	1.366	0.138	1.125	1.157	0.114	0.602	82.00	72.50	65.50
† V6551-4	with Cor. Beaver Tail Cam	1.366	0.138	1.125	1.157	N/A	0.732	82.00	72.50	65.50
† V6551-5	with Yale Standard Cam	1.366	0.138	1.125	1.157	N/A	0.709	82.00	72.50	65.50
† V6551-6	with Schlage "L" Cam	1.366	0.138	1.125	1.157	0.124	0.516	82.00	72.50	65.50
† V6551-7	with Segal Type Cam	1.366	0.138	1.125	1.157	N/A	0.779	82.00	72.50	65.50
† V6551-8	with Corbin Jumbo Cam	1.366	0.138	1.125	1.157	N/A	0.914	82.00	72.50	65.50
† V6551-9	with Best 30H Cam	1.366	0.138	1.125	1.157	0.114	0.602	82.00	72.50	65.50
† V6551-10	with Norment/AirTeq Cam	1.366	0.138	1.125	1.157	N/A	0.787	82.00	72.50	65.50
† V6551-11	with Mogul Cam	1.366	0.138	1.125	1.157	N/A	1.165	82.00	72.50	65.50
† V6551-12	with Cor. Jumbo Clover Leaf	1.366	0.138	1.125	1.157	0.114	0.828	82.00	72.50	65.50
† V6551-13	with Sargent Short Cam	1.366	0.138	1.125	1.157	N/A	0.515	82.00	72.50	65.50
† V6551-15	with Yale Rep. Cam	1.366	0.138	1.125	1.157	0.742	0.308	82.00	72.50	65.50
Twin Exclusive										
† E6551-1	with Adams Rite Cam	1.366	0.138	1.125	1.157	0.118	0.555	82.00	72.50	65.50
† E6551-2	with Sargent Cam	1.366	0.138	1.125	1.157	N/A	0.709	82.00	72.50	65.50
† E6551-3	with Cor. Clover Leaf Cam	1.366	0.138	1.125	1.157	0.114	0.602	82.00	72.50	65.50
† E6551-4	with Cor. Beaver Tail Cam	1.366	0.138	1.125	1.157	N/A	0.732	82.00	72.50	65.50
† E6551-5	with Yale Standard Cam	1.366	0.138	1.125	1.157	N/A	0.709	82.00	72.50	65.50
† E6551-6	with Schlage "L" Cam	1.366	0.138	1.125	1.157	0.124	0.516	82.00	72.50	65.50
† E6551-7	with Segal Type Cam	1.366	0.138	1.125	1.157	N/A	0.779	82.00	72.50	65.50
† E6551-8	with Corbin Jumbo Cam	1.366	0.138	1.125	1.157	N/A	0.914	82.00	72.50	65.50
† E6551-9	with Best 30H Cam	1.366	0.138	1.125	1.157	0.114	0.602	82.00	72.50	65.50
† E6551-10	with Norment/AirTeq Cam	1.366	0.138	1.125	1.157	N/A	0.787	82.00	72.50	65.50
† E6551-11	with Mogul Cam	1.366	0.138	1.125	1.157	N/A	1.165	82.00	72.50	65.50
† E6551-12	with Cor. Jumbo Clover Leaf	1.366	0.138	1.125	1.157	0.114	0.828	82.00	72.50	65.50
† E6551-13	with Sargent Short Cam	1.366	0.138	1.125	1.157	N/A	0.515	82.00	72.50	65.50
† E6551-15	with Yale Rep. Cam	1.366	0.138	1.125	1.157	0.742	0.308	82.00	72.50	65.50
Twin 6000 Classic										
† 6551-1	with Adams Rite Cam	1.366	0.138	1.125	1.157	0.118	0.555	91.00	82.00	73.00
† 6551-2	with Sargent Cam	1.366	0.138	1.125	1.157	N/A	0.709	91.00	82.00	73.00
† 6551-3	with Cor. Clover Leaf Cam	1.366	0.138	1.125	1.157	0.114	0.602	91.00	82.00	73.00
† 6551-4	with Cor. Beaver Tail Cam	1.366	0.138	1.125	1.157	N/A	0.732	91.00	82.00	73.00
† 6551-5	with Yale Standard Cam	1.366	0.138	1.125	1.157	N/A	0.709	91.00	82.00	73.00
† 6551-6	with Schlage "L" Cam	1.366	0.138	1.125	1.157	0.124	0.516	91.00	82.00	73.00
† 6551-7	with Segal Type Cam	1.366	0.138	1.125	1.157	N/A	0.779	91.00	82.00	73.00
† 6551-8	with Corbin Jumbo Cam	1.366	0.138	1.125	1.157	N/A	0.914	91.00	82.00	73.00
† 6551-9	with Best 30H Cam	1.366	0.138	1.125	1.157	0.114	0.602	91.00	82.00	73.00
† 6551-10	with Norment/AirTeq Cam	1.366	0.138	1.125	1.157	N/A	0.787	91.00	82.00	73.00
† 6551-11	with Mogul Cam	1.366	0.138	1.125	1.157	N/A	1.165	91.00	82.00	73.00
† 6551-12	with Cor. Jumbo Clover Leaf	1.366	0.138	1.125	1.157	0.114	0.828	91.00	82.00	73.00
† 6551-13	with Sargent Short Cam	1.366	0.138	1.125	1.157	N/A	0.515	91.00	82.00	73.00
† 6551-15	with Yale Rep. Cam	1.366	0.138	1.125	1.157	0.742	0.308	91.00	82.00	73.00

† Available in special function cylinders, see page 4, add \$29.00.

TWIN V-10, TWIN EXCLUSIVE, TWIN PRO, TWIN MAXIMUM, CLIQ

Mortise Cylinders

1-1/8" Mortise Cylinder

Model/Cam#	Description	HD	HT	BL	BD	R-A	R-B	Comp	Sub	SNS	
Twin Pro											
† 6151-1	with Adams Rite Cam	1.366	0.138	1.125	1.157	0.118	0.555	82.00	72.50	65.50	
† 6151-2	with Sargent Cam	1.366	0.138	1.125	1.157	N/A	0.709	82.00	72.50	65.50	
† 6151-3	with Cor. Clover Leaf Cam	1.366	0.138	1.125	1.157	0.114	0.602	82.00	72.50	65.50	
† 6151-4	with Cor. Beaver Tail Cam	1.366	0.138	1.125	1.157	N/A	0.732	82.00	72.50	65.50	
† 6151-5	with Yale Standard Cam	1.366	0.138	1.125	1.157	N/A	0.709	82.00	72.50	65.50	
† 6151-6	with Schlage "L" Cam	1.366	0.138	1.125	1.157	0.124	0.516	82.00	72.50	65.50	
† 6151-7	with Segal Type Cam	1.366	0.138	1.125	1.157	N/A	0.779	82.00	72.50	65.50	
† 6151-8	with Corbin Jumbo Cam	1.366	0.138	1.125	1.157	N/A	0.914	82.00	72.50	65.50	
† 6151-9	with Best 30H Cam	1.366	0.138	1.125	1.157	0.114	0.602	82.00	72.50	65.50	
† 6151-10	with Norment/AirTeq Cam	1.366	0.138	1.125	1.157	N/A	0.787	82.00	72.50	65.50	
† 6151-11	with Mogul Cam	1.366	0.138	1.125	1.157	N/A	1.165	82.00	72.50	65.50	
† 6151-12	w/ Cor. Jumbo Clover Leaf	1.366	0.138	1.125	1.157	0.114	0.828	82.00	72.50	65.50	
† 6151-13	with Sargent Short Cam	1.366	0.138	1.125	1.157	N/A	0.515	82.00	72.50	65.50	
† 6151-15	with Yale Rep. Cam	1.366	0.138	1.125	1.157	0.742	0.308	82.00	72.50	65.50	
Twin Maximum											
† 8851-1	with Adams Rite Cam	1.366	0.138	1.125	1.157	0.118	0.555	82.00	72.50	65.50	
† 8851-2	with Sargent Cam	1.366	0.138	1.125	1.157	N/A	0.709	82.00	72.50	65.50	
† 8851-3	with Cor. Clover Leaf Cam	1.366	0.138	1.125	1.157	0.114	0.602	82.00	72.50	65.50	
† 8851-4	with Cor. Beaver Tail Cam	1.366	0.138	1.125	1.157	N/A	0.732	82.00	72.50	65.50	
† 8851-5	with Yale Standard Cam	1.366	0.138	1.125	1.157	N/A	0.709	82.00	72.50	65.50	
† 8851-6	with Schlage "L" Cam	1.366	0.138	1.125	1.157	0.124	0.516	82.00	72.50	65.50	
† 8851-7	with Segal Type Cam	1.366	0.138	1.125	1.157	N/A	0.779	82.00	72.50	65.50	
† 8851-8	with Corbin Jumbo Cam	1.366	0.138	1.125	1.157	N/A	0.914	82.00	72.50	65.50	
† 8851-9	with Best 30H Cam	1.366	0.138	1.125	1.157	0.114	0.602	82.00	72.50	65.50	
† 8851-10	with Norment/AirTeq Cam	1.366	0.138	1.125	1.157	N/A	0.787	82.00	72.50	65.50	
† 8851-11	with Mogul Cam	1.366	0.138	1.125	1.157	N/A	1.165	82.00	72.50	65.50	
† 8851-12	w/ Cor. Jumbo Clover Leaf	1.366	0.138	1.125	1.157	0.114	0.828	82.00	72.50	65.50	
† 8851-13	with Sargent Short Cam	1.366	0.138	1.125	1.157	N/A	0.515	82.00	72.50	65.50	
† 8851-15	with Yale Rep. Cam	1.366	0.138	1.125	1.157	0.742	0.308	82.00	72.50	65.50	
Twin Maximum Medium Security											
† 2851-1	with Adams Rite Cam	1.366	0.138	1.125	1.157	0.118	0.555	65.50	58.00	51.00	
† 2851-2	with Sargent Cam	1.366	0.138	1.125	1.157	N/A	0.709	65.50	58.00	51.00	
† 2851-3	with Cor. Clover Leaf Cam	1.366	0.138	1.125	1.157	0.114	0.602	65.50	58.00	51.00	
† 2851-4	with Cor. Beaver Tail Cam	1.366	0.138	1.125	1.157	N/A	0.732	65.50	58.00	51.00	
† 2851-5	with Yale Standard Cam	1.366	0.138	1.125	1.157	N/A	0.709	65.50	58.00	51.00	
† 2851-6	with Schlage "L" Cam	1.366	0.138	1.125	1.157	0.124	0.516	65.50	58.00	51.00	
† 2851-7	with Segal Type Cam	1.366	0.138	1.125	1.157	N/A	0.779	65.50	58.00	51.00	
† 2851-8	with Corbin Jumbo Cam	1.366	0.138	1.125	1.157	N/A	0.914	65.50	58.00	51.00	
† 2851-9	with Best 30H Cam	1.366	0.138	1.125	1.157	0.114	0.602	65.50	58.00	51.00	
† 2851-10	with Norment/AirTeq Cam	1.366	0.138	1.125	1.157	N/A	0.787	65.50	58.00	51.00	
† 2851-11	with Mogul Cam	1.366	0.138	1.125	1.157	N/A	1.165	65.50	58.00	51.00	
† 2851-12	w/ Cor. Jumbo Clover Leaf	1.366	0.138	1.125	1.157	0.114	0.828	65.50	58.00	51.00	
† 2851-13	with Sargent Short Cam	1.366	0.138	1.125	1.157	N/A	0.515	65.50	58.00	51.00	
† 2851-15	with Yale Rep. Cam	1.366	0.138	1.125	1.157	0.742	0.308	65.50	58.00	51.00	
Twin Low & Twin 600 Series Classic											
Low	600	Description	HD	HT	BL	BD	R-A	R-B	COMP	SUB	—
L651-1	651-1	with Adams Rite Cam	1.366	0.138	1.125	1.157	0.118	0.555	74.00	68.00	—
L651-2	651-2	with Sargent Cam	1.366	0.138	1.125	1.157	N/A	0.709	74.00	68.00	—
L651-3	651-3	with Cor. Clover Leaf Cam	1.366	0.138	1.125	1.157	0.114	0.602	74.00	68.00	—
L651-4	651-4	with Cor. Beaver Tail Cam	1.366	0.138	1.125	1.157	N/A	0.732	74.00	68.00	—
L651-5	651-5	with Yale Standard Cam	1.366	0.138	1.125	1.157	N/A	0.709	74.00	68.00	—
L651-6	651-6	with Schlage "L" Cam	1.366	0.138	1.125	1.157	0.124	0.516	74.00	68.00	—
L651-7	651-7	with Segal Type Cam	1.366	0.138	1.125	1.157	N/A	0.779	74.00	68.00	—
L651-8	651-8	with Corbin Jumbo Cam	1.366	0.138	1.125	1.157	N/A	0.914	74.00	68.00	—
L651-9	651-9	with Best 30H Cam	1.366	0.138	1.125	1.157	0.114	0.602	74.00	68.00	—
L651-10	651-10	with Norment/AirTeq Cam	1.366	0.138	1.125	1.157	N/A	0.787	74.00	68.00	—
L651-11	651-11	with Mogul Cam	1.366	0.138	1.125	1.157	N/A	1.165	74.00	68.00	—
L651-12	651-12	w/ Cor. Jumbo Clover Leaf	1.366	0.138	1.125	1.157	0.114	0.828	74.00	68.00	—
L651-13	651-13	with Sargent Short Cam	1.366	0.138	1.125	1.157	N/A	0.515	74.00	68.00	—
L651-15	651-15	with Yale Rep. Cam	1.366	0.138	1.125	1.157	0.742	0.308	74.00	68.00	—

– Twin Maximum available with CLIQ™ Technology, add \$500.00. Example: 8851-1 x **CLIQ** x 626 x Sidebar x Comp
 † Available in special function cylinders, see page 4, add \$29.00.

TWIN V-10, TWIN EXCLUSIVE, TWIN PRO, TWIN MAXIMUM, CLIQ

Mortise Cylinders

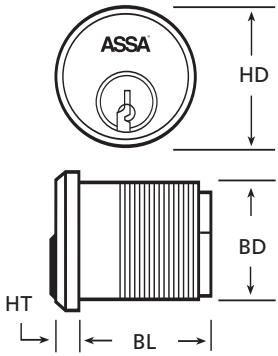

Mortise Cylinder Key:
 HD – Head Diameter
 HT – Head Thickness
 BL – Body Length
 (Includes Cam)
 BD – Body Diameter

Available Cams

Cam Key:
 R-A – Head Radius • R-B – Overall Radius

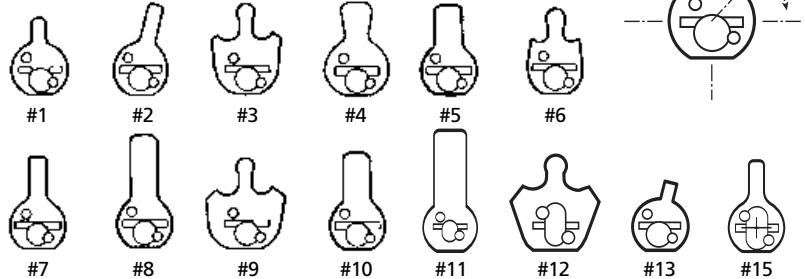

1-1/4" Mortise Cylinder

Model/Cam#	Description	HD	HT	BL	BD	R-A	R-B	Comp	Sub	SNS
Twin V-10										
† V6552-1	with Adams Rite Cam	1.366	0.138	1.25	1.157	0.118	0.555	83.00	73.50	66.50
† V6552-2	with Sargent Cam	1.366	0.138	1.25	1.157	N/A	0.709	83.00	73.50	66.50
† V6552-3	with Cor. Clover Leaf Cam	1.366	0.138	1.25	1.157	0.114	0.602	83.00	73.50	66.50
† V6552-4	with Cor. Beaver Tail Cam	1.366	0.138	1.25	1.157	N/A	0.732	83.00	73.50	66.50
† V6552-5	with Yale Standard Cam	1.366	0.138	1.25	1.157	N/A	0.709	83.00	73.50	66.50
† V6552-6	with Schlage "L" Cam	1.366	0.138	1.25	1.157	0.124	0.516	83.00	73.50	66.50
† V6552-7	with Segal Type Cam	1.366	0.138	1.25	1.157	N/A	0.779	83.00	73.50	66.50
† V6552-8	with Corbin Jumbo Cam	1.366	0.138	1.25	1.157	N/A	0.914	83.00	73.50	66.50
† V6552-9	with Best 30H Cam	1.366	0.138	1.25	1.157	0.114	0.602	83.00	73.50	66.50
† V6552-10	with Norment/AirTeq Cam	1.366	0.138	1.25	1.157	N/A	0.787	83.00	73.50	66.50
† V6552-11	with Mogul Cam	1.366	0.138	1.25	1.157	N/A	1.165	83.00	73.50	66.50
† V6552-12	with Cor. Jumbo Clover Leaf	1.366	0.138	1.25	1.157	0.114	0.828	83.00	73.50	66.50
† V6552-13	with Sargent Short Cam	1.366	0.138	1.25	1.157	N/A	0.515	83.00	73.50	66.50
† V6552-15	with Yale Rep. Cam	1.366	0.138	1.25	1.157	0.742	0.308	83.00	73.50	66.50
Twin Exclusive										
† E6552-1	with Adams Rite Cam	1.366	0.138	1.25	1.157	0.118	0.555	83.00	73.50	66.50
† E6552-2	with Sargent Cam	1.366	0.138	1.25	1.157	N/A	0.709	83.00	73.50	66.50
† E6552-3	with Cor. Clover Leaf Cam	1.366	0.138	1.25	1.157	0.114	0.602	83.00	73.50	66.50
† E6552-4	with Cor. Beaver Tail Cam	1.366	0.138	1.25	1.157	N/A	0.732	83.00	73.50	66.50
† E6552-5	with Yale Standard Cam	1.366	0.138	1.25	1.157	N/A	0.709	83.00	73.50	66.50
† E6552-6	with Schlage "L" Cam	1.366	0.138	1.25	1.157	0.124	0.516	83.00	73.50	66.50
† E6552-7	with Segal Type Cam	1.366	0.138	1.25	1.157	N/A	0.779	83.00	73.50	66.50
† E6552-8	with Corbin Jumbo Cam	1.366	0.138	1.25	1.157	N/A	0.914	83.00	73.50	66.50
† E6552-9	with Best 30H Cam	1.366	0.138	1.25	1.157	0.114	0.602	83.00	73.50	66.50
† E6552-10	with Norment/AirTeq Cam	1.366	0.138	1.25	1.157	N/A	0.787	83.00	73.50	66.50
† E6552-11	with Mogul Cam	1.366	0.138	1.25	1.157	N/A	1.165	83.00	73.50	66.50
† E6552-12	with Cor. Jumbo Clover Leaf	1.366	0.138	1.25	1.157	0.114	0.828	83.00	73.50	66.50
† E6552-13	with Sargent Short Cam	1.366	0.138	1.25	1.157	N/A	0.515	83.00	73.50	66.50
† E6552-15	with Yale Rep. Cam	1.366	0.138	1.25	1.157	0.742	0.308	83.00	73.50	66.50
Twin 6000 Classic										
† 6552-1	with Adams Rite Cam	1.366	0.138	1.25	1.157	0.118	0.555	95.00	86.00	77.00
† 6552-2	with Sargent Cam	1.366	0.138	1.25	1.157	N/A	0.709	95.00	86.00	77.00
† 6552-3	with Cor. Clover Leaf Cam	1.366	0.138	1.25	1.157	0.114	0.602	95.00	86.00	77.00
† 6552-4	with Cor. Beaver Tail Cam	1.366	0.138	1.25	1.157	N/A	0.732	95.00	86.00	77.00
† 6552-5	with Yale Standard Cam	1.366	0.138	1.25	1.157	N/A	0.709	95.00	86.00	77.00
† 6552-6	with Schlage "L" Cam	1.366	0.138	1.25	1.157	0.124	0.516	95.00	86.00	77.00
† 6552-7	with Segal Type Cam	1.366	0.138	1.25	1.157	N/A	0.779	95.00	86.00	77.00
† 6552-8	with Corbin Jumbo Cam	1.366	0.138	1.25	1.157	N/A	0.914	95.00	86.00	77.00
† 6552-9	with Best 30H Cam	1.366	0.138	1.25	1.157	0.114	0.602	95.00	86.00	77.00
† 6552-10	with Norment/AirTeq Cam	1.366	0.138	1.25	1.157	N/A	0.787	95.00	86.00	77.00
† 6552-11	with Mogul Cam	1.366	0.138	1.25	1.157	N/A	1.165	95.00	86.00	77.00
† 6552-12	with Cor. Jumbo Clover Leaf	1.366	0.138	1.25	1.157	0.114	0.828	95.00	86.00	77.00
† 6552-13	with Sargent Short Cam	1.366	0.138	1.25	1.157	N/A	0.515	95.00	86.00	77.00
† 6552-15	with Yale Rep. Cam	1.366	0.138	1.25	1.157	0.742	0.308	95.00	86.00	77.00

† Available in special function cylinders, see page 4, add \$29.00.

TWIN V-10, TWIN EXCLUSIVE, TWIN PRO, TWIN MAXIMUM, CLIQ

Mortise Cylinders

1-1/4" Mortise Cylinder

Model/Cam#	Description	HD	HT	BL	BD	R-A	R-B	Comp	Sub	SNS	
Twin Pro											
† 6152-1	with Adams Rite Cam	1.366	0.138	1.125	1.157	0.118	0.555	83.00	73.50	66.50	
† 6152-2	with Sargent Cam	1.366	0.138	1.125	1.157	N/A	0.709	83.00	73.50	66.50	
† 6152-3	with Cor. Clover Leaf Cam	1.366	0.138	1.125	1.157	0.114	0.602	83.00	73.50	66.50	
† 6152-4	with Cor. Beaver Tail Cam	1.366	0.138	1.125	1.157	N/A	0.732	83.00	73.50	66.50	
† 6152-5	with Yale Standard Cam	1.366	0.138	1.125	1.157	N/A	0.709	83.00	73.50	66.50	
† 6152-6	with Schlage "L" Cam	1.366	0.138	1.125	1.157	0.124	0.516	83.00	73.50	66.50	
† 6152-7	with Segal Type Cam	1.366	0.138	1.125	1.157	N/A	0.779	83.00	73.50	66.50	
† 6152-8	with Corbin Jumbo Cam	1.366	0.138	1.125	1.157	N/A	0.914	83.00	73.50	66.50	
† 6152-9	with Best 30H Cam	1.366	0.138	1.125	1.157	0.114	0.602	83.00	73.50	66.50	
† 6152-10	with Norment/AirTeq Cam	1.366	0.138	1.125	1.157	N/A	0.787	83.00	73.50	66.50	
† 6152-11	with Mogul Cam	1.366	0.138	1.125	1.157	N/A	1.165	83.00	73.50	66.50	
† 6152-12	w/ Cor. Jumbo Clover Leaf	1.366	0.138	1.125	1.157	0.114	0.828	83.00	73.50	66.50	
† 6152-13	with Sargent Short Cam	1.366	0.138	1.125	1.157	N/A	0.515	83.00	73.50	66.50	
† 6152-15	with Yale Rep. Cam	1.366	0.138	1.125	1.157	0.742	0.308	83.00	73.50	66.50	
Twin Maximum											
† 8852-1	with Adams Rite Cam	1.366	0.138	1.125	1.157	0.118	0.555	83.00	73.50	66.50	
† 8852-2	with Sargent Cam	1.366	0.138	1.125	1.157	N/A	0.709	83.00	73.50	66.50	
† 8852-3	with Cor. Clover Leaf Cam	1.366	0.138	1.125	1.157	0.114	0.602	83.00	73.50	66.50	
† 8852-4	with Cor. Beaver Tail Cam	1.366	0.138	1.125	1.157	N/A	0.732	83.00	73.50	66.50	
† 8852-5	with Yale Standard Cam	1.366	0.138	1.125	1.157	N/A	0.709	83.00	73.50	66.50	
† 8852-6	with Schlage "L" Cam	1.366	0.138	1.125	1.157	0.124	0.516	83.00	73.50	66.50	
† 8852-7	with Segal Type Cam	1.366	0.138	1.125	1.157	N/A	0.779	83.00	73.50	66.50	
† 8852-8	with Corbin Jumbo Cam	1.366	0.138	1.125	1.157	N/A	0.914	83.00	73.50	66.50	
† 8852-9	with Best 30H Cam	1.366	0.138	1.125	1.157	0.114	0.602	83.00	73.50	66.50	
† 8852-10	with Norment/AirTeq Cam	1.366	0.138	1.125	1.157	N/A	0.787	83.00	73.50	66.50	
† 8852-11	with Mogul Cam	1.366	0.138	1.125	1.157	N/A	1.165	83.00	73.50	66.50	
† 8852-12	w/ Cor. Jumbo Clover Leaf	1.366	0.138	1.125	1.157	0.114	0.828	83.00	73.50	66.50	
† 8852-13	with Sargent Short Cam	1.366	0.138	1.125	1.157	N/A	0.515	83.00	73.50	66.50	
† 8852-15	with Yale Rep. Cam	1.366	0.138	1.125	1.157	0.742	0.308	83.00	73.50	66.50	
Twin Maximum Medium Security											
† 2852-1	with Adams Rite Cam	1.366	0.138	1.125	1.157	0.118	0.555	66.50	59.00	53.00	
† 2852-2	with Sargent Cam	1.366	0.138	1.125	1.157	N/A	0.709	66.50	59.00	53.00	
† 2852-3	with Cor. Clover Leaf Cam	1.366	0.138	1.125	1.157	0.114	0.602	66.50	59.00	53.00	
† 2852-4	with Cor. Beaver Tail Cam	1.366	0.138	1.125	1.157	N/A	0.732	66.50	59.00	53.00	
† 2852-5	with Yale Standard Cam	1.366	0.138	1.125	1.157	N/A	0.709	66.50	59.00	53.00	
† 2852-6	with Schlage "L" Cam	1.366	0.138	1.125	1.157	0.124	0.516	66.50	59.00	53.00	
† 2852-7	with Segal Type Cam	1.366	0.138	1.125	1.157	N/A	0.779	66.50	59.00	53.00	
† 2852-8	with Corbin Jumbo Cam	1.366	0.138	1.125	1.157	N/A	0.914	66.50	59.00	53.00	
† 2852-9	with Best 30H Cam	1.366	0.138	1.125	1.157	0.114	0.602	66.50	59.00	53.00	
† 2852-10	with Norment/AirTeq Cam	1.366	0.138	1.125	1.157	N/A	0.787	66.50	59.00	53.00	
† 2852-11	with Mogul Cam	1.366	0.138	1.125	1.157	N/A	1.165	66.50	59.00	53.00	
† 2852-12	w/ Cor. Jumbo Clover Leaf	1.366	0.138	1.125	1.157	0.114	0.828	66.50	59.00	53.00	
† 2852-13	with Sargent Short Cam	1.366	0.138	1.125	1.157	N/A	0.515	66.50	59.00	53.00	
† 2852-15	with Yale Rep. Cam	1.366	0.138	1.125	1.157	0.742	0.308	66.50	59.00	53.00	
Twin Low & Twin 600 Series Classic											
Low	600	Description	HD	HT	BL	BD	R-A	R-B	COMP	SUB	—
L652-1	652-1	with Adams Rite Cam	1.366	0.138	1.125	1.157	0.118	0.555	84.00	79.00	—
L652-2	652-2	with Sargent Cam	1.366	0.138	1.125	1.157	N/A	0.709	84.00	79.00	—
L652-3	652-3	with Cor. Clover Leaf Cam	1.366	0.138	1.125	1.157	0.114	0.602	84.00	79.00	—
L652-4	652-4	with Cor. Beaver Tail Cam	1.366	0.138	1.125	1.157	N/A	0.732	84.00	79.00	—
L652-5	652-5	with Yale Standard Cam	1.366	0.138	1.125	1.157	N/A	0.709	84.00	79.00	—
L652-6	652-6	with Schlage "L" Cam	1.366	0.138	1.125	1.157	0.124	0.516	84.00	79.00	—
L652-7	652-7	with Segal Type Cam	1.366	0.138	1.125	1.157	N/A	0.779	84.00	79.00	—
L652-8	652-8	with Corbin Jumbo Cam	1.366	0.138	1.125	1.157	N/A	0.914	84.00	79.00	—
L652-9	652-9	with Best 30H Cam	1.366	0.138	1.125	1.157	0.114	0.602	84.00	79.00	—
L652-10	652-10	with Norment/AirTeq Cam	1.366	0.138	1.125	1.157	N/A	0.787	84.00	79.00	—
L652-11	652-11	with Mogul Cam	1.366	0.138	1.125	1.157	N/A	1.165	84.00	79.00	—
L652-12	652-12	w/ Cor. Jumbo Clover Leaf	1.366	0.138	1.125	1.157	0.114	0.828	84.00	79.00	—
L652-13	652-13	with Sargent Short Cam	1.366	0.138	1.125	1.157	N/A	0.515	84.00	79.00	—
L652-15	652-15	with Yale Rep. Cam	1.366	0.138	1.125	1.157	0.742	0.308	84.00	79.00	—

– Twin Maximum available with CLIQ™ Technology, add \$500.00. Example: 8852-1 x **CLIQ** x 626 x Sidebar x Comp
 † Available in special function cylinders, see page 4, add \$29.00.

TWIN V-10, TWIN EXCLUSIVE, TWIN PRO, TWIN MAXIMUM, CLIQ

Mortise Cylinders

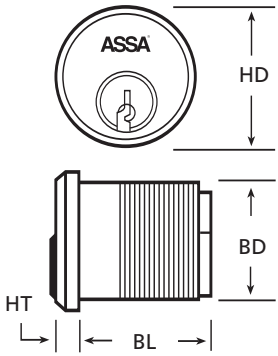

Mortise Cylinder Key:
 HD – Head Diameter
 HT – Head Thickness
 BL – Body Length
 (Includes Cam)
 BD – Body Diameter

Available Cams

Cam Key:
 R-A – Head Radius • R-B – Overall Radius

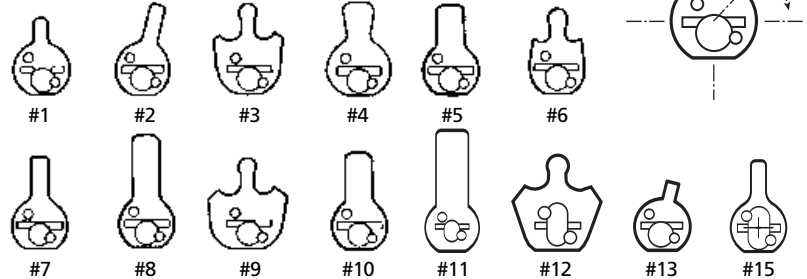

1-3/8" Mortise Cylinder

Model/Cam#	Description	HD	HT	BL	BD	R-A	R-B	Comp	Sub	SNS
Twin V-10										
V6553-1	with Adams Rite Cam	1.366	0.138	1.375	1.157	0.118	0.555	155.00	147.50	140.50
V6553-2	with Sargent Cam	1.366	0.138	1.375	1.157	N/A	0.709	155.00	147.50	140.50
V6553-3	with Cor. Clover Leaf Cam	1.366	0.138	1.375	1.157	0.114	0.602	155.00	147.50	140.50
V6553-4	with Cor. Beaver Tail Cam	1.366	0.138	1.375	1.157	N/A	0.732	155.00	147.50	140.50
V6553-5	with Yale Standard Cam	1.366	0.138	1.375	1.157	N/A	0.709	155.00	147.50	140.50
V6553-6	with Schlage "L" Cam	1.366	0.138	1.375	1.157	0.124	0.516	155.00	147.50	140.50
V6553-7	with Segal Type Cam	1.366	0.138	1.375	1.157	N/A	0.779	155.00	147.50	140.50
V6553-8	with Corbin Jumbo Cam	1.366	0.138	1.375	1.157	N/A	0.914	155.00	147.50	140.50
V6553-9	with Best 30H Cam	1.366	0.138	1.375	1.157	0.114	0.602	155.00	147.50	140.50
V6553-10	with Norment/AirTeq Cam	1.366	0.138	1.375	1.157	N/A	0.787	155.00	147.50	140.50
V6553-11	with Mogul Cam	1.366	0.138	1.375	1.157	N/A	1.165	155.00	147.50	140.50
V6553-12	with Cor. Jumbo Clover Leaf	1.366	0.138	1.375	1.157	0.114	0.828	155.00	147.50	140.50
V6553-13	with Sargent Short Cam	1.366	0.138	1.375	1.157	N/A	0.515	155.00	147.50	140.50
V6553-15	with Yale Rep. Cam	1.366	0.138	1.375	1.157	0.742	0.308	155.00	147.50	140.50
Twin Exclusive										
E6553-1	with Adams Rite Cam	1.366	0.138	1.375	1.157	0.118	0.555	155.00	147.50	140.50
E6553-2	with Sargent Cam	1.366	0.138	1.375	1.157	N/A	0.709	155.00	147.50	140.50
E6553-3	with Cor. Clover Leaf Cam	1.366	0.138	1.375	1.157	0.114	0.602	155.00	147.50	140.50
E6553-4	with Cor. Beaver Tail Cam	1.366	0.138	1.375	1.157	N/A	0.732	155.00	147.50	140.50
E6553-5	with Yale Standard Cam	1.366	0.138	1.375	1.157	N/A	0.709	155.00	147.50	140.50
E6553-6	with Schlage "L" Cam	1.366	0.138	1.375	1.157	0.124	0.516	155.00	147.50	140.50
E6553-7	with Segal Type Cam	1.366	0.138	1.375	1.157	N/A	0.779	155.00	147.50	140.50
E6553-8	with Corbin Jumbo Cam	1.366	0.138	1.375	1.157	N/A	0.914	155.00	147.50	140.50
E6553-9	with Best 30H Cam	1.366	0.138	1.375	1.157	0.114	0.602	155.00	147.50	140.50
E6553-10	with Norment/AirTeq Cam	1.366	0.138	1.375	1.157	N/A	0.787	155.00	147.50	140.50
E6553-11	with Mogul Cam	1.366	0.138	1.375	1.157	N/A	1.165	155.00	147.50	140.50
E6553-12	with Cor. Jumbo Clover Leaf	1.366	0.138	1.375	1.157	0.114	0.828	155.00	147.50	140.50
E6553-13	with Sargent Short Cam	1.366	0.138	1.375	1.157	N/A	0.515	155.00	147.50	140.50
E6553-15	with Yale Rep. Cam	1.366	0.138	1.375	1.157	0.742	0.308	155.00	147.50	140.50
Twin 6000 Classic										
6553-1	with Adams Rite Cam	1.366	0.138	1.375	1.157	0.118	0.555	157.50	148.50	139.50
6553-2	with Sargent Cam	1.366	0.138	1.375	1.157	N/A	0.709	157.50	148.50	139.50
6553-3	with Cor. Clover Leaf Cam	1.366	0.138	1.375	1.157	0.114	0.602	157.50	148.50	139.50
6553-4	with Cor. Beaver Tail Cam	1.366	0.138	1.375	1.157	N/A	0.732	157.50	148.50	139.50
6553-5	with Yale Standard Cam	1.366	0.138	1.375	1.157	N/A	0.709	157.50	148.50	139.50
6553-6	with Schlage "L" Cam	1.366	0.138	1.375	1.157	0.124	0.516	157.50	148.50	139.50
6553-7	with Segal Type Cam	1.366	0.138	1.375	1.157	N/A	0.779	157.50	148.50	139.50
6553-8	with Corbin Jumbo Cam	1.366	0.138	1.375	1.157	N/A	0.914	157.50	148.50	139.50
6553-9	with Best 30H Cam	1.366	0.138	1.375	1.157	0.114	0.602	157.50	148.50	139.50
6553-10	with Norment/AirTeq Cam	1.366	0.138	1.375	1.157	N/A	0.787	157.50	148.50	139.50
6553-11	with Mogul Cam	1.366	0.138	1.375	1.157	N/A	1.165	157.50	148.50	139.50
6553-12	with Cor. Jumbo Clover Leaf	1.366	0.138	1.375	1.157	0.114	0.828	157.50	148.50	139.50
6553-13	with Sargent Short Cam	1.366	0.138	1.375	1.157	N/A	0.515	157.50	148.50	139.50
6553-15	with Yale Rep. Cam	1.366	0.138	1.375	1.157	0.742	0.308	157.50	148.50	139.50

TWIN V-10, TWIN EXCLUSIVE, TWIN PRO, TWIN MAXIMUM, CLIQ

Mortise Cylinders

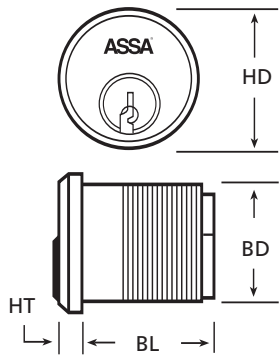

Mortise Cylinder Key:
 HD – Head Diameter
 HT – Head Thickness
 BL – Body Length (Includes Cam)
 BD – Body Diameter

Available Cams

Cam Key:
 R-A – Head Radius • R-B – Overall Radius

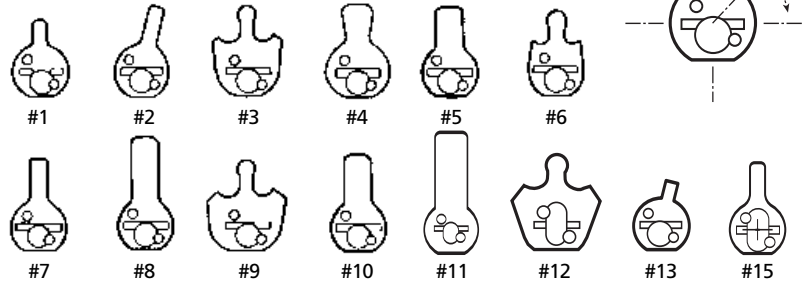

1-3/8" Mortise Cylinder

Model/Cam#	Description	HD	HT	BL	BD	R-A	R-B	Comp	Sub	SNS	
Twin Pro											
6153-1	with Adams Rite Cam	1.366	0.138	1.375	1.157	0.118	0.555	155.00	147.50	140.50	
6153-2	with Sargent Cam	1.366	0.138	1.375	1.157	N/A	0.709	155.00	147.50	140.50	
6153-3	with Cor. Clover Leaf Cam	1.366	0.138	1.375	1.157	0.114	0.602	155.00	147.50	140.50	
6153-4	with Cor. Beaver Tail Cam	1.366	0.138	1.375	1.157	N/A	0.732	155.00	147.50	140.50	
6153-5	with Yale Standard Cam	1.366	0.138	1.375	1.157	N/A	0.709	155.00	147.50	140.50	
6153-6	with Schlage "L" Cam	1.366	0.138	1.375	1.157	0.124	0.516	155.00	147.50	140.50	
6153-7	with Segal Type Cam	1.366	0.138	1.375	1.157	N/A	0.779	155.00	147.50	140.50	
6153-8	with Corbin Jumbo Cam	1.366	0.138	1.375	1.157	N/A	0.914	155.00	147.50	140.50	
6153-9	with Best 30H Cam	1.366	0.138	1.375	1.157	0.114	0.602	155.00	147.50	140.50	
6153-10	with Norment/AirTeq Cam	1.366	0.138	1.375	1.157	N/A	0.787	155.00	147.50	140.50	
6153-11	with Mogul Cam	1.366	0.138	1.375	1.157	N/A	1.165	155.00	147.50	140.50	
6153-12	w/ Cor. Jumbo Clover Leaf	1.366	0.138	1.375	1.157	0.114	0.828	155.00	147.50	140.50	
6153-13	with Sargent Short Cam	1.366	0.138	1.375	1.157	N/A	0.515	155.00	147.50	140.50	
6153-15	with Yale Rep. Cam	1.366	0.138	1.375	1.157	0.742	0.308	155.00	147.50	140.50	
Twin Maximum											
8853-1	with Adams Rite Cam	1.366	0.138	1.375	1.157	0.118	0.555	155.00	147.50	140.50	
8853-2	with Sargent Cam	1.366	0.138	1.375	1.157	N/A	0.709	155.00	147.50	140.50	
8853-3	with Cor. Clover Leaf Cam	1.366	0.138	1.375	1.157	0.114	0.602	155.00	147.50	140.50	
8853-4	with Cor. Beaver Tail Cam	1.366	0.138	1.375	1.157	N/A	0.732	155.00	147.50	140.50	
8853-5	with Yale Standard Cam	1.366	0.138	1.375	1.157	N/A	0.709	155.00	147.50	140.50	
8853-6	with Schlage "L" Cam	1.366	0.138	1.375	1.157	0.124	0.516	155.00	147.50	140.50	
8853-7	with Segal Type Cam	1.366	0.138	1.375	1.157	N/A	0.779	155.00	147.50	140.50	
8853-8	with Corbin Jumbo Cam	1.366	0.138	1.375	1.157	N/A	0.914	155.00	147.50	140.50	
8853-9	with Best 30H Cam	1.366	0.138	1.375	1.157	0.114	0.602	155.00	147.50	140.50	
8853-10	with Norment/AirTeq Cam	1.366	0.138	1.375	1.157	N/A	0.787	155.00	147.50	140.50	
8853-11	with Mogul Cam	1.366	0.138	1.375	1.157	N/A	1.165	155.00	147.50	140.50	
8853-12	w/ Cor. Jumbo Clover Leaf	1.366	0.138	1.375	1.157	0.114	0.828	155.00	147.50	140.50	
8853-13	with Sargent Short Cam	1.366	0.138	1.375	1.157	N/A	0.515	155.00	147.50	140.50	
8853-15	with Yale Rep. Cam	1.366	0.138	1.375	1.157	0.742	0.308	155.00	147.50	140.50	
Twin Low & Twin 600 Series Classic											
Low	600	Description	HD	HT	BL	BD	R-A	R-B	COMP	SUB	—
L653-1	653-1	with Adams Rite Cam	1.366	0.138	1.375	1.157	0.118	0.555	141.00	132.00	—
L653-2	653-2	with Sargent Cam	1.366	0.138	1.375	1.157	N/A	0.709	141.00	132.00	—
L653-3	653-3	with Cor. Clover Leaf Cam	1.366	0.138	1.375	1.157	0.114	0.602	141.00	132.00	—
L653-4	653-4	with Cor. Beaver Tail Cam	1.366	0.138	1.375	1.157	N/A	0.732	141.00	132.00	—
L653-5	653-5	with Yale Standard Cam	1.366	0.138	1.375	1.157	N/A	0.709	141.00	132.00	—
L653-6	653-6	with Schlage "L" Cam	1.366	0.138	1.375	1.157	0.124	0.516	141.00	132.00	—
L653-7	653-7	with Segal Type Cam	1.366	0.138	1.375	1.157	N/A	0.779	141.00	132.00	—
L653-8	653-8	with Corbin Jumbo Cam	1.366	0.138	1.375	1.157	N/A	0.914	141.00	132.00	—
L653-9	653-9	with Best 30H Cam	1.366	0.138	1.375	1.157	0.114	0.602	141.00	132.00	—
L653-10	653-10	with Norment/AirTeq Cam	1.366	0.138	1.375	1.157	N/A	0.787	141.00	132.00	—
L653-11	653-11	with Mogul Cam	1.366	0.138	1.375	1.157	N/A	1.165	141.00	132.00	—
L653-12	653-12	w/ Cor. Jumbo Clover Leaf	1.366	0.138	1.375	1.157	0.114	0.828	141.00	132.00	—
L653-13	653-13	with Sargent Short Cam	1.366	0.138	1.375	1.157	N/A	0.515	141.00	132.00	—
L653-15	653-15	with Yale Rep. Cam	1.366	0.138	1.375	1.157	0.742	0.308	141.00	132.00	—

– Twin Maximum available with CLIQ™ Technology, add \$500.00. Example: 8853-1 x **CLIQ** x 626 x Sidebar x Comp

TWIN V-10, TWIN EXCLUSIVE, TWIN PRO, TWIN MAXIMUM, CLIQ

Mortise Cylinders

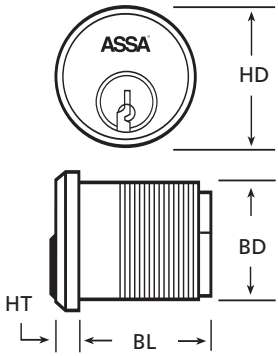

Mortise Cylinder Key:
 HD – Head Diameter
 HT – Head Thickness
 BL – Body Length
 (Includes Cam)
 BD – Body Diameter

Available Cams

Cam Key:
 R-A – Head Radius • R-B – Overall Radius

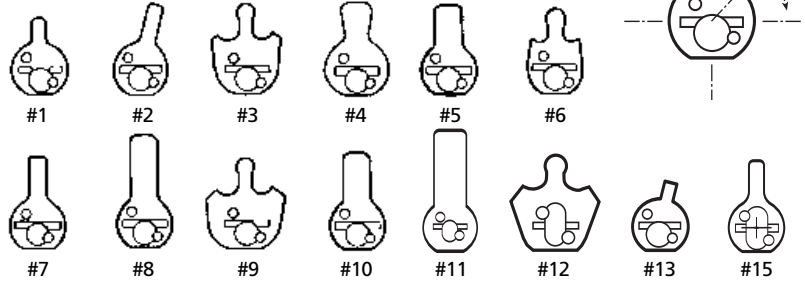

1-1/2" Mortise Cylinder

Model/Cam#	Description	HD	HT	BL	BD	R-A	R-B	Comp	Sub	SNS
Twin V-10										
V6554-1	with Adams Rite Cam	1.366	0.138	1.50	1.157	0.118	0.555	156.00	148.50	141.50
V6554-2	with Sargent Cam	1.366	0.138	1.50	1.157	N/A	0.709	156.00	148.50	141.50
V6554-3	with Cor. Clover Leaf Cam	1.366	0.138	1.50	1.157	0.114	0.602	156.00	148.50	141.50
V6554-4	with Cor. Beaver Tail Cam	1.366	0.138	1.50	1.157	N/A	0.732	156.00	148.50	141.50
V6554-5	with Yale Standard Cam	1.366	0.138	1.50	1.157	N/A	0.709	156.00	148.50	141.50
V6554-6	with Schlage "L" Cam	1.366	0.138	1.50	1.157	0.124	0.516	156.00	148.50	141.50
V6554-7	with Segal Type Cam	1.366	0.138	1.50	1.157	N/A	0.779	156.00	148.50	141.50
V6554-8	with Corbin Jumbo Cam	1.366	0.138	1.50	1.157	N/A	0.914	156.00	148.50	141.50
V6554-9	with Best 30H Cam	1.366	0.138	1.50	1.157	0.114	0.602	156.00	148.50	141.50
V6554-10	with Norment/AirTeq Cam	1.366	0.138	1.50	1.157	N/A	0.787	156.00	148.50	141.50
V6554-11	with Mogul Cam	1.366	0.138	1.50	1.157	N/A	1.165	156.00	148.50	141.50
V6554-12	with Cor. Jumbo Clover Leaf	1.366	0.138	1.50	1.157	0.114	0.828	156.00	148.50	141.50
V6554-13	with Sargent Short Cam	1.366	0.138	1.50	1.157	N/A	0.515	156.00	148.50	141.50
V6554-15	with Yale Rep. Cam	1.366	0.138	1.50	1.157	0.742	0.308	156.00	148.50	141.50
Twin Exclusive										
E6554-1	with Adams Rite Cam	1.366	0.138	1.50	1.157	0.118	0.555	156.00	148.50	141.50
E6554-2	with Sargent Cam	1.366	0.138	1.50	1.157	N/A	0.709	156.00	148.50	141.50
E6554-3	with Cor. Clover Leaf Cam	1.366	0.138	1.50	1.157	0.114	0.602	156.00	148.50	141.50
E6554-4	with Cor. Beaver Tail Cam	1.366	0.138	1.50	1.157	N/A	0.732	156.00	148.50	141.50
E6554-5	with Yale Standard Cam	1.366	0.138	1.50	1.157	N/A	0.709	156.00	148.50	141.50
E6554-6	with Schlage "L" Cam	1.366	0.138	1.50	1.157	0.124	0.516	156.00	148.50	141.50
E6554-7	with Segal Type Cam	1.366	0.138	1.50	1.157	N/A	0.779	156.00	148.50	141.50
E6554-8	with Corbin Jumbo Cam	1.366	0.138	1.50	1.157	N/A	0.914	156.00	148.50	141.50
E6554-9	with Best 30H Cam	1.366	0.138	1.50	1.157	0.114	0.602	156.00	148.50	141.50
E6554-10	with Norment/AirTeq Cam	1.366	0.138	1.50	1.157	N/A	0.787	156.00	148.50	141.50
E6554-11	with Mogul Cam	1.366	0.138	1.50	1.157	N/A	1.165	156.00	148.50	141.50
E6554-12	with Cor. Jumbo Clover Leaf	1.366	0.138	1.50	1.157	0.114	0.828	156.00	148.50	141.50
E6554-13	with Sargent Short Cam	1.366	0.138	1.50	1.157	N/A	0.515	156.00	148.50	141.50
E6554-15	with Yale Rep. Cam	1.366	0.138	1.50	1.157	0.742	0.308	156.00	148.50	141.50
Twin 6000 Classic										
6554-1	with Adams Rite Cam	1.366	0.138	1.50	1.157	0.118	0.555	158.50	149.50	140.50
6554-2	with Sargent Cam	1.366	0.138	1.50	1.157	N/A	0.709	158.50	149.50	140.50
6554-3	with Cor. Clover Leaf Cam	1.366	0.138	1.50	1.157	0.114	0.602	158.50	149.50	140.50
6554-4	with Cor. Beaver Tail Cam	1.366	0.138	1.50	1.157	N/A	0.732	158.50	149.50	140.50
6554-5	with Yale Standard Cam	1.366	0.138	1.50	1.157	N/A	0.709	158.50	149.50	140.50
6554-6	with Schlage "L" Cam	1.366	0.138	1.50	1.157	0.124	0.516	158.50	149.50	140.50
6554-7	with Segal Type Cam	1.366	0.138	1.50	1.157	N/A	0.779	158.50	149.50	140.50
6554-8	with Corbin Jumbo Cam	1.366	0.138	1.50	1.157	N/A	0.914	158.50	149.50	140.50
6554-9	with Best 30H Cam	1.366	0.138	1.50	1.157	0.114	0.602	158.50	149.50	140.50
6554-10	with Norment/AirTeq Cam	1.366	0.138	1.50	1.157	N/A	0.787	158.50	149.50	140.50
6554-11	with Mogul Cam	1.366	0.138	1.50	1.157	N/A	1.165	158.50	149.50	140.50
6554-12	with Cor. Jumbo Clover Leaf	1.366	0.138	1.50	1.157	0.114	0.828	158.50	149.50	140.50
6554-13	with Sargent Short Cam	1.366	0.138	1.50	1.157	N/A	0.515	158.50	149.50	140.50
6554-15	with Yale Rep. Cam	1.366	0.138	1.50	1.157	0.742	0.308	158.50	149.50	140.50

TWIN V-10, TWIN EXCLUSIVE, TWIN PRO, TWIN MAXIMUM, CLIQ

Mortise Cylinders

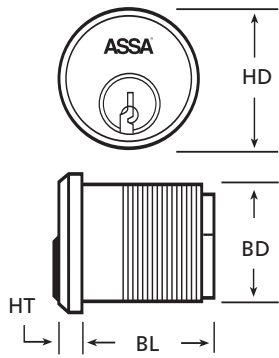

Mortise Cylinder Key:
 HD – Head Diameter
 HT – Head Thickness
 BL – Body Length
 (Includes Cam)
 BD – Body Diameter

Available Cams

Cam Key:
 R-A – Head Radius • R-B – Overall Radius

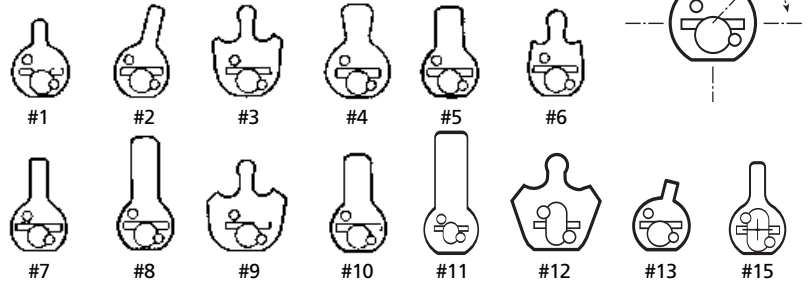

1-1/2" Mortise Cylinder

Model/Cam#	Description	HD	HT	BL	BD	R-A	R-B	Comp	Sub	SNS	
Twin Pro											
6154-1	with Adams Rite Cam	1.366	0.138	1.50	1.157	0.118	0.555	156.00	148.50	141.50	
6154-2	with Sargent Cam	1.366	0.138	1.50	1.157	N/A	0.709	156.00	148.50	141.50	
6154-3	with Cor. Clover Leaf Cam	1.366	0.138	1.50	1.157	0.114	0.602	156.00	148.50	141.50	
6154-4	with Cor. Beaver Tail Cam	1.366	0.138	1.50	1.157	N/A	0.732	156.00	148.50	141.50	
6154-5	with Yale Standard Cam	1.366	0.138	1.50	1.157	N/A	0.709	156.00	148.50	141.50	
6154-6	with Schlage "L" Cam	1.366	0.138	1.50	1.157	0.124	0.516	156.00	148.50	141.50	
6154-7	with Segal Type Cam	1.366	0.138	1.50	1.157	N/A	0.779	156.00	148.50	141.50	
6154-8	with Corbin Jumbo Cam	1.366	0.138	1.50	1.157	N/A	0.914	156.00	148.50	141.50	
6154-9	with Best 30H Cam	1.366	0.138	1.50	1.157	0.114	0.602	156.00	148.50	141.50	
6154-10	with Norment/AirTeq Cam	1.366	0.138	1.50	1.157	N/A	0.787	156.00	148.50	141.50	
6154-11	with Mogul Cam	1.366	0.138	1.50	1.157	N/A	1.165	156.00	148.50	141.50	
6154-12	with Cor. Jumbo Clover Leaf	1.366	0.138	1.50	1.157	0.114	0.828	156.00	148.50	141.50	
6154-13	with Sargent Short Cam	1.366	0.138	1.50	1.157	N/A	0.515	156.00	148.50	141.50	
6154-15	with Yale Rep. Cam	1.366	0.138	1.50	1.157	0.742	0.308	156.00	148.50	141.50	
Twin Maximum											
8854-1	with Adams Rite Cam	1.366	0.138	1.50	1.157	0.118	0.555	156.00	148.50	141.50	
8854-2	with Sargent Cam	1.366	0.138	1.50	1.157	N/A	0.709	156.00	148.50	141.50	
8854-3	with Cor. Clover Leaf Cam	1.366	0.138	1.50	1.157	0.114	0.602	156.00	148.50	141.50	
8854-4	with Cor. Beaver Tail Cam	1.366	0.138	1.50	1.157	N/A	0.732	156.00	148.50	141.50	
8854-5	with Yale Standard Cam	1.366	0.138	1.50	1.157	N/A	0.709	156.00	148.50	141.50	
8854-6	with Schlage "L" Cam	1.366	0.138	1.50	1.157	0.124	0.516	156.00	148.50	141.50	
8854-7	with Segal Type Cam	1.366	0.138	1.50	1.157	N/A	0.779	156.00	148.50	141.50	
8854-8	with Corbin Jumbo Cam	1.366	0.138	1.50	1.157	N/A	0.914	156.00	148.50	141.50	
8854-9	with Best 30H Cam	1.366	0.138	1.50	1.157	0.114	0.602	156.00	148.50	141.50	
8854-10	with Norment/AirTeq Cam	1.366	0.138	1.50	1.157	N/A	0.787	156.00	148.50	141.50	
8854-11	with Mogul Cam	1.366	0.138	1.50	1.157	N/A	1.165	156.00	148.50	141.50	
8854-12	w/ Cor. Jumbo Clover Leaf	1.366	0.138	1.50	1.157	0.114	0.828	156.00	148.50	141.50	
8854-13	with Sargent Short Cam	1.366	0.138	1.50	1.157	N/A	0.515	156.00	148.50	141.50	
8854-15	with Yale Rep. Cam	1.366	0.138	1.50	1.157	0.742	0.308	156.00	148.50	141.50	
Twin Low & Twin 600 Series Classic											
Low	600	Description	HD	HT	BL	BD	R-A	R-B	COMP	SUB	—
L654-1	654-1	with Adams Rite Cam	1.366	0.138	1.50	1.157	0.118	0.555	142.00	133.00	—
L654-2	654-2	with Sargent Cam	1.366	0.138	1.50	1.157	N/A	0.709	142.00	133.00	—
L654-3	654-3	with Cor. Clover Leaf Cam	1.366	0.138	1.50	1.157	0.114	0.602	142.00	133.00	—
L654-4	654-4	with Cor. Beaver Tail Cam	1.366	0.138	1.50	1.157	N/A	0.732	142.00	133.00	—
L654-5	654-5	with Yale Standard Cam	1.366	0.138	1.50	1.157	N/A	0.709	142.00	133.00	—
L654-6	654-6	with Schlage "L" Cam	1.366	0.138	1.50	1.157	0.124	0.516	142.00	133.00	—
L654-7	654-7	with Segal Type Cam	1.366	0.138	1.50	1.157	N/A	0.779	142.00	133.00	—
L654-8	654-8	with Corbin Jumbo Cam	1.366	0.138	1.50	1.157	N/A	0.914	142.00	133.00	—
L654-9	654-9	with Best 30H Cam	1.366	0.138	1.50	1.157	0.114	0.602	142.00	133.00	—
L654-10	654-10	with Norment/AirTeq Cam	1.366	0.138	1.50	1.157	N/A	0.787	142.00	133.00	—
L654-11	654-11	with Mogul Cam	1.366	0.138	1.50	1.157	N/A	1.165	142.00	133.00	—
L654-12	654-12	w/ Cor. Jumbo Clover Leaf	1.366	0.138	1.50	1.157	0.114	0.828	142.00	133.00	—
L654-13	654-13	with Sargent Short Cam	1.366	0.138	1.50	1.157	N/A	0.515	142.00	133.00	—
L654-15	654-15	with Yale Rep. Cam	1.366	0.138	1.50	1.157	0.742	0.308	142.00	133.00	—

– Twin Maximum available with CLIQ™ Technology, add \$500.00. Example: 8854-1 x **CLIQ** x 626 x Sidebar x Comp

TWIN V-10, TWIN EXCLUSIVE, TWIN PRO, TWIN MAXIMUM, CLIQ

Mortise Cylinders

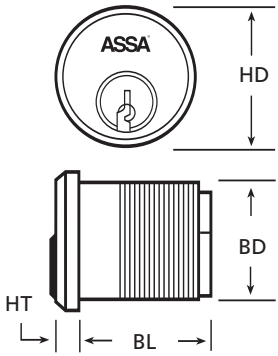

Mortise Cylinder Key:
HD – Head Diameter
HT – Head Thickness
BL – Body Length
 (Includes Cam)
BD – Body Diameter

Available Cams

Cam Key:
R-A – Head Radius • **R-B** – Overall Radius

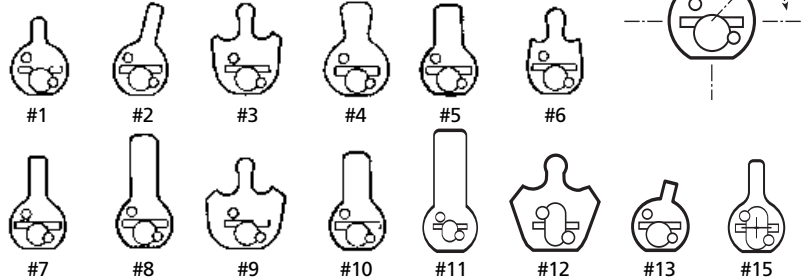

1-5/8" Mortise Cylinder

Model/Cam#	Description	HD	HT	BL	BD	R-A	R-B	Comp	Sub	SNS
Twin V-10										
V6555-1	with Adams Rite Cam	1.366	0.138	1.625	1.157	0.118	0.555	157.00	149.50	142.50
V6555-2	with Sargent Cam	1.366	0.138	1.625	1.157	N/A	0.709	157.00	149.50	142.50
V6555-3	with Cor. Clover Leaf Cam	1.366	0.138	1.625	1.157	0.114	0.602	157.00	149.50	142.50
V6555-4	with Cor. Beaver Tail Cam	1.366	0.138	1.625	1.157	N/A	0.732	157.00	149.50	142.50
V6555-5	with Yale Standard Cam	1.366	0.138	1.625	1.157	N/A	0.709	157.00	149.50	142.50
V6555-6	with Schlage "L" Cam	1.366	0.138	1.625	1.157	0.124	0.516	157.00	149.50	142.50
V6555-7	with Segal Type Cam	1.366	0.138	1.625	1.157	N/A	0.779	157.00	149.50	142.50
V6555-8	with Corbin Jumbo Cam	1.366	0.138	1.625	1.157	N/A	0.914	157.00	149.50	142.50
V6555-9	with Best 30H Cam	1.366	0.138	1.625	1.157	0.114	0.602	157.00	149.50	142.50
V6555-10	with Norment/AirTeq Cam	1.366	0.138	1.625	1.157	N/A	0.787	157.00	149.50	142.50
V6555-11	with Mogul Cam	1.366	0.138	1.625	1.157	N/A	1.165	157.00	149.50	142.50
V6555-12	with Cor. Jumbo Clover Leaf	1.366	0.138	1.625	1.157	0.114	0.828	157.00	149.50	142.50
V6555-13	with Sargent Short Cam	1.366	0.138	1.625	1.157	N/A	0.515	157.00	149.50	142.50
V6555-15	with Yale Rep. Cam	1.366	0.138	1.625	1.157	0.742	0.308	157.00	149.50	142.50
Twin Exclusive										
E6555-1	with Adams Rite Cam	1.366	0.138	1.625	1.157	0.118	0.555	157.00	149.50	142.50
E6555-2	with Sargent Cam	1.366	0.138	1.625	1.157	N/A	0.709	157.00	149.50	142.50
E6555-3	with Cor. Clover Leaf Cam	1.366	0.138	1.625	1.157	0.114	0.602	157.00	149.50	142.50
E6555-4	with Cor. Beaver Tail Cam	1.366	0.138	1.625	1.157	N/A	0.732	157.00	149.50	142.50
E6555-5	with Yale Standard Cam	1.366	0.138	1.625	1.157	N/A	0.709	157.00	149.50	142.50
E6555-6	with Schlage "L" Cam	1.366	0.138	1.625	1.157	0.124	0.516	157.00	149.50	142.50
E6555-7	with Segal Type Cam	1.366	0.138	1.625	1.157	N/A	0.779	157.00	149.50	142.50
E6555-8	with Corbin Jumbo Cam	1.366	0.138	1.625	1.157	N/A	0.914	157.00	149.50	142.50
E6555-9	with Best 30H Cam	1.366	0.138	1.625	1.157	0.114	0.602	157.00	149.50	142.50
E6555-10	with Norment/AirTeq Cam	1.366	0.138	1.625	1.157	N/A	0.787	157.00	149.50	142.50
E6555-11	with Mogul Cam	1.366	0.138	1.625	1.157	N/A	1.165	157.00	149.50	142.50
E6555-12	with Cor. Jumbo Clover Leaf	1.366	0.138	1.625	1.157	0.114	0.828	157.00	149.50	142.50
E6555-13	with Sargent Short Cam	1.366	0.138	1.625	1.157	N/A	0.515	157.00	149.50	142.50
E6555-15	with Yale Rep. Cam	1.366	0.138	1.625	1.157	0.742	0.308	157.00	149.50	142.50
Twin 6000 Classic										
6555-1	with Adams Rite Cam	1.366	0.138	1.625	1.157	0.118	0.555	160.50	151.50	142.50
6555-2	with Sargent Cam	1.366	0.138	1.625	1.157	N/A	0.709	160.50	151.50	142.50
6555-3	with Cor. Clover Leaf Cam	1.366	0.138	1.625	1.157	0.114	0.602	160.50	151.50	142.50
6555-4	with Cor. Beaver Tail Cam	1.366	0.138	1.625	1.157	N/A	0.732	160.50	151.50	142.50
6555-5	with Yale Standard Cam	1.366	0.138	1.625	1.157	N/A	0.709	160.50	151.50	142.50
6555-6	with Schlage "L" Cam	1.366	0.138	1.625	1.157	0.124	0.516	160.50	151.50	142.50
6555-7	with Segal Type Cam	1.366	0.138	1.625	1.157	N/A	0.779	160.50	151.50	142.50
6555-8	with Corbin Jumbo Cam	1.366	0.138	1.625	1.157	N/A	0.914	160.50	151.50	142.50
6555-9	with Best 30H Cam	1.366	0.138	1.625	1.157	0.114	0.602	160.50	151.50	142.50
6555-10	with Norment/AirTeq Cam	1.366	0.138	1.625	1.157	N/A	0.787	160.50	151.50	142.50
6555-11	with Mogul Cam	1.366	0.138	1.625	1.157	N/A	1.165	160.50	151.50	142.50
6555-12	with Cor. Jumbo Clover Leaf	1.366	0.138	1.625	1.157	0.114	0.828	160.50	151.50	142.50
6555-13	with Sargent Short Cam	1.366	0.138	1.625	1.157	N/A	0.515	160.50	151.50	142.50
6555-15	with Yale Rep. Cam	1.366	0.138	1.625	1.157	0.742	0.308	160.50	151.50	142.50

TWIN V-10, TWIN EXCLUSIVE, TWIN PRO, TWIN MAXIMUM, CLIQ

Mortise Cylinders

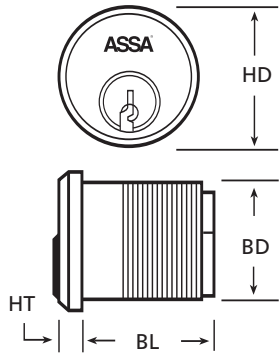

Mortise Cylinder Key:
 HD – Head Diameter
 HT – Head Thickness
 BL – Body Length (Includes Cam)
 BD – Body Diameter

Available Cams

Cam Key:
 R-A – Head Radius • R-B – Overall Radius

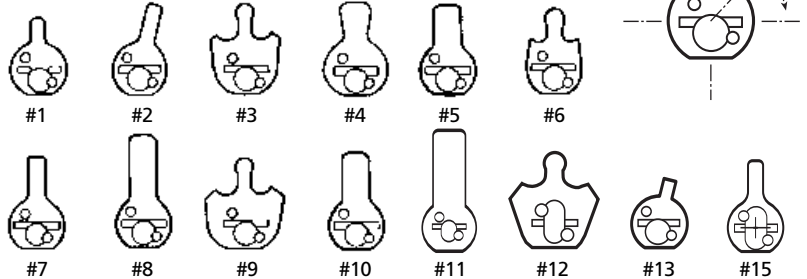

1-5/8" Mortise Cylinder

Model/Cam#	Description	HD	HT	BL	BD	R-A	R-B	Comp	Sub	SNS	
Twin Pro											
6155-1	with Adams Rite Cam	1.366	0.138	1.625	1.157	0.118	0.555	157.00	149.50	142.50	
6155-2	with Sargent Cam	1.366	0.138	1.625	1.157	N/A	0.709	157.00	149.50	142.50	
6155-3	with Cor. Clover Leaf Cam	1.366	0.138	1.625	1.157	0.114	0.602	157.00	149.50	142.50	
6155-4	with Cor. Beaver Tail Cam	1.366	0.138	1.625	1.157	N/A	0.732	157.00	149.50	142.50	
6155-5	with Yale Standard Cam	1.366	0.138	1.625	1.157	N/A	0.709	157.00	149.50	142.50	
6155-6	with Schlage "L" Cam	1.366	0.138	1.625	1.157	0.124	0.516	157.00	149.50	142.50	
6155-7	with Segal Type Cam	1.366	0.138	1.625	1.157	N/A	0.779	157.00	149.50	142.50	
6155-8	with Corbin Jumbo Cam	1.366	0.138	1.625	1.157	N/A	0.914	157.00	149.50	142.50	
6155-9	with Best 30H Cam	1.366	0.138	1.625	1.157	0.114	0.602	157.00	149.50	142.50	
6155-10	with Norment/AirTeq Cam	1.366	0.138	1.625	1.157	N/A	0.787	157.00	149.50	142.50	
6155-11	with Mogul Cam	1.366	0.138	1.625	1.157	N/A	1.165	157.00	149.50	142.50	
6155-12	with Cor. Jumbo Clover Leaf	1.366	0.138	1.625	1.157	0.114	0.828	157.00	149.50	142.50	
6155-13	with Sargent Short Cam	1.366	0.138	1.625	1.157	N/A	0.515	157.00	149.50	142.50	
6155-15	with Yale Rep. Cam	1.366	0.138	1.625	1.157	0.742	0.308	157.00	149.50	142.50	
Twin Maximum											
8855-1	with Adams Rite Cam	1.366	0.138	1.625	1.157	0.118	0.555	157.00	149.50	142.50	
8855-2	with Sargent Cam	1.366	0.138	1.625	1.157	N/A	0.709	157.00	149.50	142.50	
8855-3	with Cor. Clover Leaf Cam	1.366	0.138	1.625	1.157	0.114	0.602	157.00	149.50	142.50	
8855-4	with Cor. Beaver Tail Cam	1.366	0.138	1.625	1.157	N/A	0.732	157.00	149.50	142.50	
8855-5	with Yale Standard Cam	1.366	0.138	1.625	1.157	N/A	0.709	157.00	149.50	142.50	
8855-6	with Schlage "L" Cam	1.366	0.138	1.625	1.157	0.124	0.516	157.00	149.50	142.50	
8855-7	with Segal Type Cam	1.366	0.138	1.625	1.157	N/A	0.779	157.00	149.50	142.50	
8855-8	with Corbin Jumbo Cam	1.366	0.138	1.625	1.157	N/A	0.914	157.00	149.50	142.50	
8855-9	with Best 30H Cam	1.366	0.138	1.625	1.157	0.114	0.602	157.00	149.50	142.50	
8855-10	with Norment/AirTeq Cam	1.366	0.138	1.625	1.157	N/A	0.787	157.00	149.50	142.50	
8855-11	with Mogul Cam	1.366	0.138	1.625	1.157	N/A	1.165	157.00	149.50	142.50	
8855-12	w/ Cor. Jumbo Clover Leaf	1.366	0.138	1.625	1.157	0.114	0.828	157.00	149.50	142.50	
8855-13	with Sargent Short Cam	1.366	0.138	1.625	1.157	N/A	0.515	157.00	149.50	142.50	
8855-15	with Yale Rep. Cam	1.366	0.138	1.625	1.157	0.742	0.308	157.00	149.50	142.50	
Twin Low & Twin 600 Series Classic											
Low	600	Description	HD	HT	BL	BD	R-A	R-B	COMP	SUB	—
L655-1	655-1	with Adams Rite Cam	1.366	0.138	1.625	1.157	0.118	0.555	144.00	135.00	—
L655-2	655-2	with Sargent Cam	1.366	0.138	1.625	1.157	N/A	0.709	144.00	135.00	—
L655-3	655-3	with Cor. Clover Leaf Cam	1.366	0.138	1.625	1.157	0.114	0.602	144.00	135.00	—
L655-4	655-4	with Cor. Beaver Tail Cam	1.366	0.138	1.625	1.157	N/A	0.732	144.00	135.00	—
L655-5	655-5	with Yale Standard Cam	1.366	0.138	1.625	1.157	N/A	0.709	144.00	135.00	—
L655-6	655-6	with Schlage "L" Cam	1.366	0.138	1.625	1.157	0.124	0.516	144.00	135.00	—
L655-7	655-7	with Segal Type Cam	1.366	0.138	1.625	1.157	N/A	0.779	144.00	135.00	—
L655-8	655-8	with Corbin Jumbo Cam	1.366	0.138	1.625	1.157	N/A	0.914	144.00	135.00	—
L655-9	655-9	with Best 30H Cam	1.366	0.138	1.625	1.157	0.114	0.602	144.00	135.00	—
L655-10	655-10	with Norment/AirTeq Cam	1.366	0.138	1.625	1.157	N/A	0.787	144.00	135.00	—
L655-11	655-11	with Mogul Cam	1.366	0.138	1.625	1.157	N/A	1.165	144.00	135.00	—
L655-12	655-12	w/ Cor. Jumbo Clover Leaf	1.366	0.138	1.625	1.157	0.114	0.828	144.00	135.00	—
L655-13	655-13	with Sargent Short Cam	1.366	0.138	1.625	1.157	N/A	0.515	144.00	135.00	—
L655-15	655-15	with Yale Rep. Cam	1.366	0.138	1.625	1.157	0.742	0.308	144.00	135.00	—

– Twin Maximum available with CLIQ™ Technology, add \$500.00. Example: 8855-1 x **CLIQ** x 626 x Sidebar x Comp

TWIN V-10, TWIN EXCLUSIVE, TWIN PRO, TWIN MAXIMUM, CLIQ

Mortise Cylinders

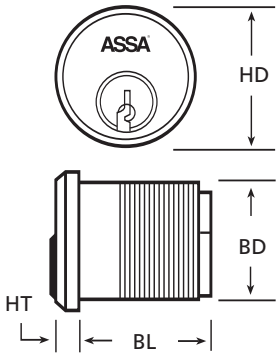

Mortise Cylinder Key:
 HD – Head Diameter
 HT – Head Thickness
 BL – Body Length
 (Includes Cam)
 BD – Body Diameter

Available Cams

Cam Key:
 R-A – Head Radius • R-B – Overall Radius

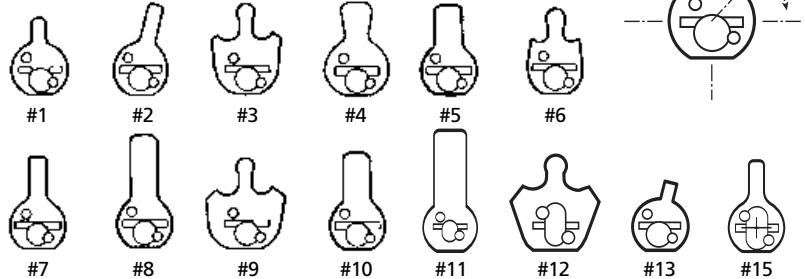

1-3/4" Mortise Cylinder

Model/Cam#	Description	HD	HT	BL	BD	R-A	R-B	Comp	Sub	SNS
Twin V-10										
V6556-1	with Adams Rite Cam	1.366	0.138	1.75	1.157	0.118	0.555	159.00	151.50	144.50
V6556-2	with Sargent Cam	1.366	0.138	1.75	1.157	N/A	0.709	159.00	151.50	144.50
V6556-3	with Cor. Clover Leaf Cam	1.366	0.138	1.75	1.157	0.114	0.602	159.00	151.50	144.50
V6556-4	with Cor. Beaver Tail Cam	1.366	0.138	1.75	1.157	N/A	0.732	159.00	151.50	144.50
V6556-5	with Yale Standard Cam	1.366	0.138	1.75	1.157	N/A	0.709	159.00	151.50	144.50
V6556-6	with Schlage "L" Cam	1.366	0.138	1.75	1.157	0.124	0.516	159.00	151.50	144.50
V6556-7	with Segal Type Cam	1.366	0.138	1.75	1.157	N/A	0.779	159.00	151.50	144.50
V6556-8	with Corbin Jumbo Cam	1.366	0.138	1.75	1.157	N/A	0.914	159.00	151.50	144.50
V6556-9	with Best 30H Cam	1.366	0.138	1.75	1.157	0.114	0.602	159.00	151.50	144.50
V6556-10	with Norment/AirTeq Cam	1.366	0.138	1.75	1.157	N/A	0.787	159.00	151.50	144.50
V6556-11	with Mogul Cam	1.366	0.138	1.75	1.157	N/A	1.165	159.00	151.50	144.50
V6556-12	with Cor. Jumbo Clover Leaf	1.366	0.138	1.75	1.157	0.114	0.828	159.00	151.50	144.50
V6556-13	with Sargent Short Cam	1.366	0.138	1.75	1.157	N/A	0.515	159.00	151.50	144.50
V6556-15	with Yale Rep. Cam	1.366	0.138	1.75	1.157	0.742	0.308	159.00	151.50	144.50
Twin Exclusive										
E6556-1	with Adams Rite Cam	1.366	0.138	1.75	1.157	0.118	0.555	159.00	151.50	144.50
E6556-2	with Sargent Cam	1.366	0.138	1.75	1.157	N/A	0.709	159.00	151.50	144.50
E6556-3	with Cor. Clover Leaf Cam	1.366	0.138	1.75	1.157	0.114	0.602	159.00	151.50	144.50
E6556-4	with Cor. Beaver Tail Cam	1.366	0.138	1.75	1.157	N/A	0.732	159.00	151.50	144.50
E6556-5	with Yale Standard Cam	1.366	0.138	1.75	1.157	N/A	0.709	159.00	151.50	144.50
E6556-6	with Schlage "L" Cam	1.366	0.138	1.75	1.157	0.124	0.516	159.00	151.50	144.50
E6556-7	with Segal Type Cam	1.366	0.138	1.75	1.157	N/A	0.779	159.00	151.50	144.50
E6556-8	with Corbin Jumbo Cam	1.366	0.138	1.75	1.157	N/A	0.914	159.00	151.50	144.50
E6556-9	with Best 30H Cam	1.366	0.138	1.75	1.157	0.114	0.602	159.00	151.50	144.50
E6556-10	with Norment/AirTeq Cam	1.366	0.138	1.75	1.157	N/A	0.787	159.00	151.50	144.50
E6556-11	with Mogul Cam	1.366	0.138	1.75	1.157	N/A	1.165	159.00	151.50	144.50
E6556-12	with Cor. Jumbo Clover Leaf	1.366	0.138	1.75	1.157	0.114	0.828	159.00	151.50	144.50
E6556-13	with Sargent Short Cam	1.366	0.138	1.75	1.157	N/A	0.515	159.00	151.50	144.50
E6556-15	with Yale Rep. Cam	1.366	0.138	1.75	1.157	0.742	0.308	159.00	151.50	144.50
Twin 6000 Classic										
6556-1	with Adams Rite Cam	1.366	0.138	1.75	1.157	0.118	0.555	164.00	154.00	145.00
6556-2	with Sargent Cam	1.366	0.138	1.75	1.157	N/A	0.709	164.00	154.00	145.00
6556-3	with Cor. Clover Leaf Cam	1.366	0.138	1.75	1.157	0.114	0.602	164.00	154.00	145.00
6556-4	with Cor. Beaver Tail Cam	1.366	0.138	1.75	1.157	N/A	0.732	164.00	154.00	145.00
6556-5	with Yale Standard Cam	1.366	0.138	1.75	1.157	N/A	0.709	164.00	154.00	145.00
6556-6	with Schlage "L" Cam	1.366	0.138	1.75	1.157	0.124	0.516	164.00	154.00	145.00
6556-7	with Segal Type Cam	1.366	0.138	1.75	1.157	N/A	0.779	164.00	154.00	145.00
6556-8	with Corbin Jumbo Cam	1.366	0.138	1.75	1.157	N/A	0.914	164.00	154.00	145.00
6556-9	with Best 30H Cam	1.366	0.138	1.75	1.157	0.114	0.602	164.00	154.00	145.00
6556-10	with Norment/AirTeq Cam	1.366	0.138	1.75	1.157	N/A	0.787	164.00	154.00	145.00
6556-11	with Mogul Cam	1.366	0.138	1.75	1.157	N/A	1.165	164.00	154.00	145.00
6556-12	with Cor. Jumbo Clover Leaf	1.366	0.138	1.75	1.157	0.114	0.828	164.00	154.00	145.00
6556-13	with Sargent Short Cam	1.366	0.138	1.75	1.157	N/A	0.515	164.00	154.00	145.00
6556-15	with Yale Rep. Cam	1.366	0.138	1.75	1.157	0.742	0.308	164.00	154.00	145.00

TWIN V-10, TWIN EXCLUSIVE, TWIN PRO, TWIN MAXIMUM, CLIQ

Mortise Cylinders

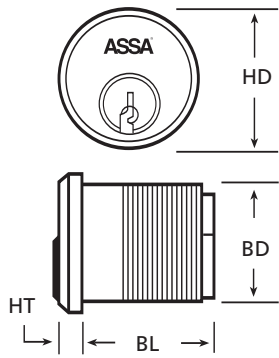

Mortise Cylinder Key:
 HD – Head Diameter
 HT – Head Thickness
 BL – Body Length (Includes Cam)
 BD – Body Diameter

Available Cams

Cam Key:
 R-A – Head Radius • R-B – Overall Radius

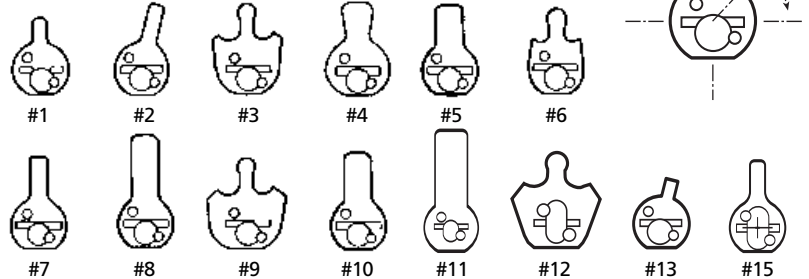

1-3/4" Mortise Cylinder

Model/Cam#	Description	HD	HT	BL	BD	R-A	R-B	Comp	Sub	SNS	
Twin Pro											
6156-1	with Adams Rite Cam	1.366	0.138	1.75	1.157	0.118	0.555	159.00	151.50	144.50	
6156-2	with Sargent Cam	1.366	0.138	1.75	1.157	N/A	0.709	159.00	151.50	144.50	
6156-3	with Cor. Clover Leaf Cam	1.366	0.138	1.75	1.157	0.114	0.602	159.00	151.50	144.50	
6156-4	with Cor. Beaver Tail Cam	1.366	0.138	1.75	1.157	N/A	0.732	159.00	151.50	144.50	
6156-5	with Yale Standard Cam	1.366	0.138	1.75	1.157	N/A	0.709	159.00	151.50	144.50	
6156-6	with Schlage "L" Cam	1.366	0.138	1.75	1.157	0.124	0.516	159.00	151.50	144.50	
6156-7	with Segal Type Cam	1.366	0.138	1.75	1.157	N/A	0.779	159.00	151.50	144.50	
6156-8	with Corbin Jumbo Cam	1.366	0.138	1.75	1.157	N/A	0.914	159.00	151.50	144.50	
6156-9	with Best 30H Cam	1.366	0.138	1.75	1.157	0.114	0.602	159.00	151.50	144.50	
6156-10	with Norment/AirTeq Cam	1.366	0.138	1.75	1.157	N/A	0.787	159.00	151.50	144.50	
6156-11	with Mogul Cam	1.366	0.138	1.75	1.157	N/A	1.165	159.00	151.50	144.50	
6156-12	with Cor. Jumbo Clover Leaf	1.366	0.138	1.75	1.157	0.114	0.828	159.00	151.50	144.50	
6156-13	with Sargent Short Cam	1.366	0.138	1.75	1.157	N/A	0.515	159.00	151.50	144.50	
6156-15	with Yale Rep. Cam	1.366	0.138	1.75	1.157	0.742	0.308	159.00	151.50	144.50	
Twin Maximum											
8856-1	with Adams Rite Cam	1.366	0.138	1.75	1.157	0.118	0.555	159.00	151.50	144.50	
8856-2	with Sargent Cam	1.366	0.138	1.75	1.157	N/A	0.709	159.00	151.50	144.50	
8856-3	with Cor. Clover Leaf Cam	1.366	0.138	1.75	1.157	0.114	0.602	159.00	151.50	144.50	
8856-4	with Cor. Beaver Tail Cam	1.366	0.138	1.75	1.157	N/A	0.732	159.00	151.50	144.50	
8856-5	with Yale Standard Cam	1.366	0.138	1.75	1.157	N/A	0.709	159.00	151.50	144.50	
8856-6	with Schlage "L" Cam	1.366	0.138	1.75	1.157	0.124	0.516	159.00	151.50	144.50	
8856-7	with Segal Type Cam	1.366	0.138	1.75	1.157	N/A	0.779	159.00	151.50	144.50	
8856-8	with Corbin Jumbo Cam	1.366	0.138	1.75	1.157	N/A	0.914	159.00	151.50	144.50	
8856-9	with Best 30H Cam	1.366	0.138	1.75	1.157	0.114	0.602	159.00	151.50	144.50	
8856-10	with Norment/AirTeq Cam	1.366	0.138	1.75	1.157	N/A	0.787	159.00	151.50	144.50	
8856-11	with Mogul Cam	1.366	0.138	1.75	1.157	N/A	1.165	159.00	151.50	144.50	
8856-12	w/ Cor. Jumbo Clover Leaf	1.366	0.138	1.75	1.157	0.114	0.828	159.00	151.50	144.50	
8856-13	with Sargent Short Cam	1.366	0.138	1.75	1.157	N/A	0.515	159.00	151.50	144.50	
8856-15	with Yale Rep. Cam	1.366	0.138	1.75	1.157	0.742	0.308	159.00	151.50	144.50	
Twin Low & Twin 600 Series Classic											
Low	600	Description	HD	HT	BL	BD	R-A	R-B	COMP	SUB	—
L656-1	656-1	with Adams Rite Cam	1.366	0.138	1.75	1.157	0.118	0.555	146.00	138.00	—
L656-2	656-2	with Sargent Cam	1.366	0.138	1.75	1.157	N/A	0.709	146.00	138.00	—
L656-3	656-3	with Cor. Clover Leaf Cam	1.366	0.138	1.75	1.157	0.114	0.602	146.00	138.00	—
L656-4	656-4	with Cor. Beaver Tail Cam	1.366	0.138	1.75	1.157	N/A	0.732	146.00	138.00	—
L656-5	656-5	with Yale Standard Cam	1.366	0.138	1.75	1.157	N/A	0.709	146.00	138.00	—
L656-6	656-6	with Schlage "L" Cam	1.366	0.138	1.75	1.157	0.124	0.516	146.00	138.00	—
L656-7	656-7	with Segal Type Cam	1.366	0.138	1.75	1.157	N/A	0.779	146.00	138.00	—
L656-8	656-8	with Corbin Jumbo Cam	1.366	0.138	1.75	1.157	N/A	0.914	146.00	138.00	—
L656-9	656-9	with Best 30H Cam	1.366	0.138	1.75	1.157	0.114	0.602	146.00	138.00	—
L656-10	656-10	with Norment/AirTeq Cam	1.366	0.138	1.75	1.157	N/A	0.787	146.00	138.00	—
L656-11	656-11	with Mogul Cam	1.366	0.138	1.75	1.157	N/A	1.165	146.00	138.00	—
L656-12	656-12	w/ Cor. Jumbo Clover Leaf	1.366	0.138	1.75	1.157	0.114	0.828	146.00	138.00	—
L656-13	656-13	with Sargent Short Cam	1.366	0.138	1.75	1.157	N/A	0.515	146.00	138.00	—
L656-15	656-15	with Yale Rep. Cam	1.366	0.138	1.75	1.157	0.742	0.308	146.00	138.00	—

– Twin Maximum available with CLIQ™ Technology, add \$500.00. Example: 8856-1 x **CLIQ** x 626 x Sidebar x Comp

TWIN V-10, TWIN EXCLUSIVE, TWIN PRO, TWIN MAXIMUM, CLIQ

Mortise Cylinders

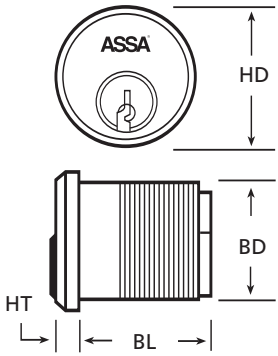

Mortise Cylinder Key:
 HD – Head Diameter
 HT – Head Thickness
 BL – Body Length
 (Includes Cam)
 BD – Body Diameter

Available Cams

Cam Key:
 R-A – Head Radius • R-B – Overall Radius

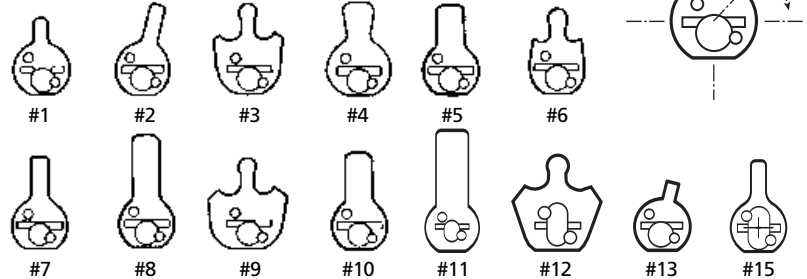

1-7/8" Mortise Cylinder

Model/Cam#	Description	HD	HT	BL	BD	R-A	R-B	Comp	Sub	SNS
Twin V-10										
V6557-1	with Adams Rite Cam	1.366	0.138	1.875	1.157	0.118	0.555	164.50	157.00	150.00
V6557-2	with Sargent Cam	1.366	0.138	1.875	1.157	N/A	0.709	164.50	157.00	150.00
V6557-3	with Cor. Clover Leaf Cam	1.366	0.138	1.875	1.157	0.114	0.602	164.50	157.00	150.00
V6557-4	with Cor. Beaver Tail Cam	1.366	0.138	1.875	1.157	N/A	0.732	164.50	157.00	150.00
V6557-5	with Yale Standard Cam	1.366	0.138	1.875	1.157	N/A	0.709	164.50	157.00	150.00
V6557-6	with Schlage "L" Cam	1.366	0.138	1.875	1.157	0.124	0.516	164.50	157.00	150.00
V6557-7	with Segal Type Cam	1.366	0.138	1.875	1.157	N/A	0.779	164.50	157.00	150.00
V6557-8	with Corbin Jumbo Cam	1.366	0.138	1.875	1.157	N/A	0.914	164.50	157.00	150.00
V6557-9	with Best 30H Cam	1.366	0.138	1.875	1.157	0.114	0.602	164.50	157.00	150.00
V6557-10	with Norment/AirTeq Cam	1.366	0.138	1.875	1.157	N/A	0.787	164.50	157.00	150.00
V6557-11	with Mogul Cam	1.366	0.138	1.875	1.157	N/A	1.165	164.50	157.00	150.00
V6557-12	with Cor. Jumbo Clover Leaf	1.366	0.138	1.875	1.157	0.114	0.828	164.50	157.00	150.00
V6557-13	with Sargent Short Cam	1.366	0.138	1.875	1.157	N/A	0.515	164.50	157.00	150.00
V6557-15	with Yale Rep. Cam	1.366	0.138	1.875	1.157	0.742	0.308	164.50	157.00	150.00
Twin Exclusive										
E6557-1	with Adams Rite Cam	1.366	0.138	1.875	1.157	0.118	0.555	164.50	157.00	150.00
E6557-2	with Sargent Cam	1.366	0.138	1.875	1.157	N/A	0.709	164.50	157.00	150.00
E6557-3	with Cor. Clover Leaf Cam	1.366	0.138	1.875	1.157	0.114	0.602	164.50	157.00	150.00
E6557-4	with Cor. Beaver Tail Cam	1.366	0.138	1.875	1.157	N/A	0.732	164.50	157.00	150.00
E6557-5	with Yale Standard Cam	1.366	0.138	1.875	1.157	N/A	0.709	164.50	157.00	150.00
E6557-6	with Schlage "L" Cam	1.366	0.138	1.875	1.157	0.124	0.516	164.50	157.00	150.00
E6557-7	with Segal Type Cam	1.366	0.138	1.875	1.157	N/A	0.779	164.50	157.00	150.00
E6557-8	with Corbin Jumbo Cam	1.366	0.138	1.875	1.157	N/A	0.914	164.50	157.00	150.00
E6557-9	with Best 30H Cam	1.366	0.138	1.875	1.157	0.114	0.602	164.50	157.00	150.00
E6557-10	with Norment/AirTeq Cam	1.366	0.138	1.875	1.157	N/A	0.787	164.50	157.00	150.00
E6557-11	with Mogul Cam	1.366	0.138	1.875	1.157	N/A	1.165	164.50	157.00	150.00
E6557-12	with Cor. Jumbo Clover Leaf	1.366	0.138	1.875	1.157	0.114	0.828	164.50	157.00	150.00
E6557-13	with Sargent Short Cam	1.366	0.138	1.875	1.157	N/A	0.515	164.50	157.00	150.00
E6557-15	with Yale Rep. Cam	1.366	0.138	1.875	1.157	0.742	0.308	164.50	157.00	150.00
Twin 6000 Classic										
6557-1	with Adams Rite Cam	1.366	0.138	1.875	1.157	0.118	0.555	168.00	159.00	150.00
6557-2	with Sargent Cam	1.366	0.138	1.875	1.157	N/A	0.709	168.00	159.00	150.00
6557-3	with Cor. Clover Leaf Cam	1.366	0.138	1.875	1.157	0.114	0.602	168.00	159.00	150.00
6557-4	with Cor. Beaver Tail Cam	1.366	0.138	1.875	1.157	N/A	0.732	168.00	159.00	150.00
6557-5	with Yale Standard Cam	1.366	0.138	1.875	1.157	N/A	0.709	168.00	159.00	150.00
6557-6	with Schlage "L" Cam	1.366	0.138	1.875	1.157	0.124	0.516	168.00	159.00	150.00
6557-7	with Segal Type Cam	1.366	0.138	1.875	1.157	N/A	0.779	168.00	159.00	150.00
6557-8	with Corbin Jumbo Cam	1.366	0.138	1.875	1.157	N/A	0.914	168.00	159.00	150.00
6557-9	with Best 30H Cam	1.366	0.138	1.875	1.157	0.114	0.602	168.00	159.00	150.00
6557-10	with Norment/AirTeq Cam	1.366	0.138	1.875	1.157	N/A	0.787	168.00	159.00	150.00
6557-11	with Mogul Cam	1.366	0.138	1.875	1.157	N/A	1.165	168.00	159.00	150.00
6557-12	with Cor. Jumbo Clover Leaf	1.366	0.138	1.875	1.157	0.114	0.828	168.00	159.00	150.00
6557-13	with Sargent Short Cam	1.366	0.138	1.875	1.157	N/A	0.515	168.00	159.00	150.00
6557-15	with Yale Rep. Cam	1.366	0.138	1.875	1.157	0.742	0.308	168.00	159.00	150.00

TWIN V-10, TWIN EXCLUSIVE, TWIN PRO, TWIN MAXIMUM, CLIQ

Mortise Cylinders

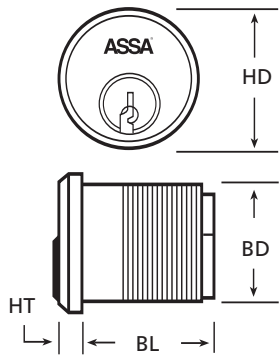

Mortise Cylinder Key:
 HD – Head Diameter
 HT – Head Thickness
 BL – Body Length (Includes Cam)
 BD – Body Diameter

Available Cams

Cam Key:
 R-A – Head Radius • R-B – Overall Radius

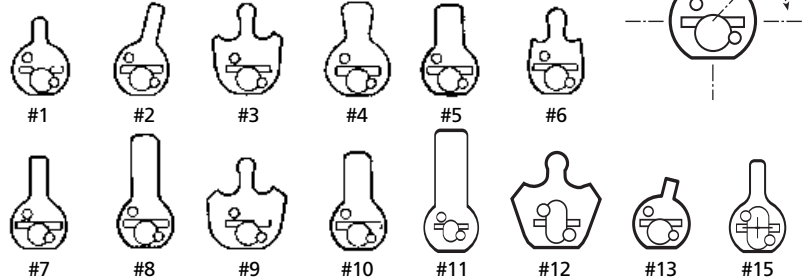

1-7/8" Mortise Cylinder

Model/Cam#	Description	HD	HT	BL	BD	R-A	R-B	Comp	Sub	SNS	
Twin Pro											
6157-1	with Adams Rite Cam	1.366	0.138	1.875	1.157	0.118	0.555	164.50	157.00	150.00	
6157-2	with Sargent Cam	1.366	0.138	1.875	1.157	N/A	0.709	164.50	157.00	150.00	
6157-3	with Cor. Clover Leaf Cam	1.366	0.138	1.875	1.157	0.114	0.602	164.50	157.00	150.00	
6157-4	with Cor. Beaver Tail Cam	1.366	0.138	1.875	1.157	N/A	0.732	164.50	157.00	150.00	
6157-5	with Yale Standard Cam	1.366	0.138	1.875	1.157	N/A	0.709	164.50	157.00	150.00	
6157-6	with Schlage "L" Cam	1.366	0.138	1.875	1.157	0.124	0.516	164.50	157.00	150.00	
6157-7	with Segal Type Cam	1.366	0.138	1.875	1.157	N/A	0.779	164.50	157.00	150.00	
6157-8	with Corbin Jumbo Cam	1.366	0.138	1.875	1.157	N/A	0.914	164.50	157.00	150.00	
6157-9	with Best 30H Cam	1.366	0.138	1.875	1.157	0.114	0.602	164.50	157.00	150.00	
6157-10	with Norment/AirTeq Cam	1.366	0.138	1.875	1.157	N/A	0.787	164.50	157.00	150.00	
6157-11	with Mogul Cam	1.366	0.138	1.875	1.157	N/A	1.165	164.50	157.00	150.00	
6157-12	with Cor. Jumbo Clover Leaf	1.366	0.138	1.875	1.157	0.114	0.828	164.50	157.00	150.00	
6157-13	with Sargent Short Cam	1.366	0.138	1.875	1.157	N/A	0.515	164.50	157.00	150.00	
6157-15	with Yale Rep. Cam	1.366	0.138	1.875	1.157	0.742	0.308	164.50	157.00	150.00	
Twin Maximum											
8857-1	with Adams Rite Cam	1.366	0.138	1.875	1.157	0.118	0.555	164.50	157.00	150.00	
8857-2	with Sargent Cam	1.366	0.138	1.875	1.157	N/A	0.709	164.50	157.00	150.00	
8857-3	with Cor. Clover Leaf Cam	1.366	0.138	1.875	1.157	0.114	0.602	164.50	157.00	150.00	
8857-4	with Cor. Beaver Tail Cam	1.366	0.138	1.875	1.157	N/A	0.732	164.50	157.00	150.00	
8857-5	with Yale Standard Cam	1.366	0.138	1.875	1.157	N/A	0.709	164.50	157.00	150.00	
8857-6	with Schlage "L" Cam	1.366	0.138	1.875	1.157	0.124	0.516	164.50	157.00	150.00	
8857-7	with Segal Type Cam	1.366	0.138	1.875	1.157	N/A	0.779	164.50	157.00	150.00	
8857-8	with Corbin Jumbo Cam	1.366	0.138	1.875	1.157	N/A	0.914	164.50	157.00	150.00	
8857-9	with Best 30H Cam	1.366	0.138	1.875	1.157	0.114	0.602	164.50	157.00	150.00	
8857-10	with Norment/AirTeq Cam	1.366	0.138	1.875	1.157	N/A	0.787	164.50	157.00	150.00	
8857-11	with Mogul Cam	1.366	0.138	1.875	1.157	N/A	1.165	164.50	157.00	150.00	
8857-12	w/ Cor. Jumbo Clover Leaf	1.366	0.138	1.875	1.157	0.114	0.828	164.50	157.00	150.00	
8857-13	with Sargent Short Cam	1.366	0.138	1.875	1.157	N/A	0.515	164.50	157.00	150.00	
8857-15	with Yale Rep. Cam	1.366	0.138	1.875	1.157	0.742	0.308	164.50	157.00	150.00	
Twin Low & Twin 600 Series Classic											
Low	600	Description	HD	HT	BL	BD	R-A	R-B	COMP	SUB	—
L657-1	657-1	with Adams Rite Cam	1.366	0.138	1.875	1.157	0.118	0.555	151.00	143.00	—
L657-2	657-2	with Sargent Cam	1.366	0.138	1.875	1.157	N/A	0.709	151.00	143.00	—
L657-3	657-3	with Cor. Clover Leaf Cam	1.366	0.138	1.875	1.157	0.114	0.602	151.00	143.00	—
L657-4	657-4	with Cor. Beaver Tail Cam	1.366	0.138	1.875	1.157	N/A	0.732	151.00	143.00	—
L657-5	657-5	with Yale Standard Cam	1.366	0.138	1.875	1.157	N/A	0.709	151.00	143.00	—
L657-6	657-6	with Schlage "L" Cam	1.366	0.138	1.875	1.157	0.124	0.516	151.00	143.00	—
L657-7	657-7	with Segal Type Cam	1.366	0.138	1.875	1.157	N/A	0.779	151.00	143.00	—
L657-8	657-8	with Corbin Jumbo Cam	1.366	0.138	1.875	1.157	N/A	0.914	151.00	143.00	—
L657-9	657-9	with Best 30H Cam	1.366	0.138	1.875	1.157	0.114	0.602	151.00	143.00	—
L657-10	657-10	with Norment/AirTeq Cam	1.366	0.138	1.875	1.157	N/A	0.787	151.00	143.00	—
L657-11	657-11	with Mogul Cam	1.366	0.138	1.875	1.157	N/A	1.165	151.00	143.00	—
L657-12	657-12	w/ Cor. Jumbo Clover Leaf	1.366	0.138	1.875	1.157	0.114	0.828	151.00	143.00	—
L657-13	657-13	with Sargent Short Cam	1.366	0.138	1.875	1.157	N/A	0.515	151.00	143.00	—
L657-15	657-15	with Yale Rep. Cam	1.366	0.138	1.875	1.157	0.742	0.308	151.00	143.00	—

– Twin Maximum available with CLIQ™ Technology, add \$500.00. Example: 8857-1 x **CLIQ** x 626 x Sidebar x Comp

TWIN V-10, TWIN EXCLUSIVE, TWIN PRO, TWIN MAXIMUM, CLIQ

Mortise Cylinders

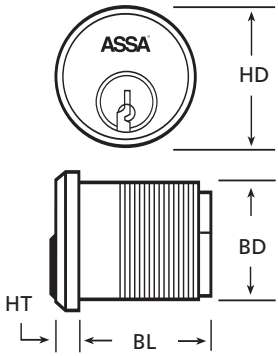

Mortise Cylinder Key:
 HD – Head Diameter
 HT – Head Thickness
 BL – Body Length
 (Includes Cam)
 BD – Body Diameter

Available Cams

Cam Key:
 R-A – Head Radius • R-B – Overall Radius

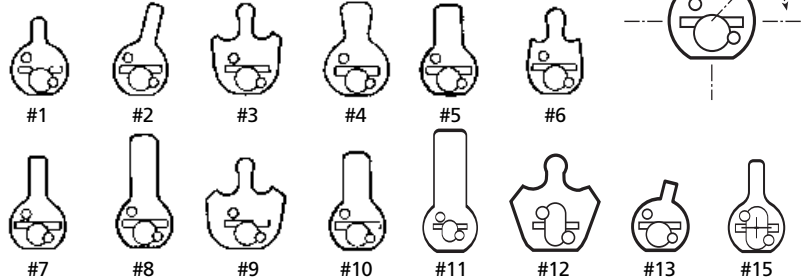

2" Mortise Cylinder

Model/Cam#	Description	HD	HT	BL	BD	R-A	R-B	Comp	Sub	SNS
Twin V-10										
V6558-1	with Adams Rite Cam	1.366	0.138	2.00	1.157	0.118	0.555	175.50	168.00	161.00
V6558-2	with Sargent Cam	1.366	0.138	2.00	1.157	N/A	0.709	175.50	168.00	161.00
V6558-3	with Cor. Clover Leaf Cam	1.366	0.138	2.00	1.157	0.114	0.602	175.50	168.00	161.00
V6558-4	with Cor. Beaver Tail Cam	1.366	0.138	2.00	1.157	N/A	0.732	175.50	168.00	161.00
V6558-5	with Yale Standard Cam	1.366	0.138	2.00	1.157	N/A	0.709	175.50	168.00	161.00
V6558-6	with Schlage "L" Cam	1.366	0.138	2.00	1.157	0.124	0.516	175.50	168.00	161.00
V6558-7	with Segal Type Cam	1.366	0.138	2.00	1.157	N/A	0.779	175.50	168.00	161.00
V6558-8	with Corbin Jumbo Cam	1.366	0.138	2.00	1.157	N/A	0.914	175.50	168.00	161.00
V6558-9	with Best 30H Cam	1.366	0.138	2.00	1.157	0.114	0.602	175.50	168.00	161.00
V6558-10	with Norment/AirTeq Cam	1.366	0.138	2.00	1.157	N/A	0.787	175.50	168.00	161.00
V6558-11	with Mogul Cam	1.366	0.138	2.00	1.157	N/A	1.165	175.50	168.00	161.00
V6558-12	with Cor. Jumbo Clover Leaf	1.366	0.138	2.00	1.157	0.114	0.828	175.50	168.00	161.00
V6558-13	with Sargent Short Cam	1.366	0.138	2.00	1.157	N/A	0.515	175.50	168.00	161.00
V6558-15	with Yale Rep. Cam	1.366	0.138	2.00	1.157	0.742	0.308	175.50	168.00	161.00
Twin Exclusive										
E6558-1	with Adams Rite Cam	1.366	0.138	2.00	1.157	0.118	0.555	175.50	168.00	161.00
E6558-2	with Sargent Cam	1.366	0.138	2.00	1.157	N/A	0.709	175.50	168.00	161.00
E6558-3	with Cor. Clover Leaf Cam	1.366	0.138	2.00	1.157	0.114	0.602	175.50	168.00	161.00
E6558-4	with Cor. Beaver Tail Cam	1.366	0.138	2.00	1.157	N/A	0.732	175.50	168.00	161.00
E6558-5	with Yale Standard Cam	1.366	0.138	2.00	1.157	N/A	0.709	175.50	168.00	161.00
E6558-6	with Schlage "L" Cam	1.366	0.138	2.00	1.157	0.124	0.516	175.50	168.00	161.00
E6558-7	with Segal Type Cam	1.366	0.138	2.00	1.157	N/A	0.779	175.50	168.00	161.00
E6558-8	with Corbin Jumbo Cam	1.366	0.138	2.00	1.157	N/A	0.914	175.50	168.00	161.00
E6558-9	with Best 30H Cam	1.366	0.138	2.00	1.157	0.114	0.602	175.50	168.00	161.00
E6558-10	with Norment/AirTeq Cam	1.366	0.138	2.00	1.157	N/A	0.787	175.50	168.00	161.00
E6558-11	with Mogul Cam	1.366	0.138	2.00	1.157	N/A	1.165	175.50	168.00	161.00
E6558-12	with Cor. Jumbo Clover Leaf	1.366	0.138	2.00	1.157	0.114	0.828	175.50	168.00	161.00
E6558-13	with Sargent Short Cam	1.366	0.138	2.00	1.157	N/A	0.515	175.50	168.00	161.00
E6558-15	with Yale Rep. Cam	1.366	0.138	2.00	1.157	0.742	0.308	175.50	168.00	161.00
Twin 6000 Classic										
6558-1	with Adams Rite Cam	1.366	0.138	2.00	1.157	0.118	0.555	179.50	171.50	161.50
6558-2	with Sargent Cam	1.366	0.138	2.00	1.157	N/A	0.709	179.50	171.50	161.50
6558-3	with Cor. Clover Leaf Cam	1.366	0.138	2.00	1.157	0.114	0.602	179.50	171.50	161.50
6558-4	with Cor. Beaver Tail Cam	1.366	0.138	2.00	1.157	N/A	0.732	179.50	171.50	161.50
6558-5	with Yale Standard Cam	1.366	0.138	2.00	1.157	N/A	0.709	179.50	171.50	161.50
6558-6	with Schlage "L" Cam	1.366	0.138	2.00	1.157	0.124	0.516	179.50	171.50	161.50
6558-7	with Segal Type Cam	1.366	0.138	2.00	1.157	N/A	0.779	179.50	171.50	161.50
6558-8	with Corbin Jumbo Cam	1.366	0.138	2.00	1.157	N/A	0.914	179.50	171.50	161.50
6558-9	with Best 30H Cam	1.366	0.138	2.00	1.157	0.114	0.602	179.50	171.50	161.50
6558-10	with Norment/AirTeq Cam	1.366	0.138	2.00	1.157	N/A	0.787	179.50	171.50	161.50
6558-11	with Mogul Cam	1.366	0.138	2.00	1.157	N/A	1.165	179.50	171.50	161.50
6558-12	with Cor. Jumbo Clover Leaf	1.366	0.138	2.00	1.157	0.114	0.828	179.50	171.50	161.50
6558-13	with Sargent Short Cam	1.366	0.138	2.00	1.157	N/A	0.515	179.50	171.50	161.50
6558-15	with Yale Rep. Cam	1.366	0.138	2.00	1.157	0.742	0.308	179.50	171.50	161.50

TWIN V-10, TWIN EXCLUSIVE, TWIN PRO, TWIN MAXIMUM, CLIQ

Mortise Cylinders

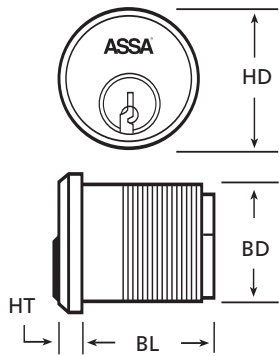

Mortise Cylinder Key:
 HD – Head Diameter
 HT – Head Thickness
 BL – Body Length
 (Includes Cam)
 BD – Body Diameter

Available Cams

Cam Key:
 R-A – Head Radius • R-B – Overall Radius

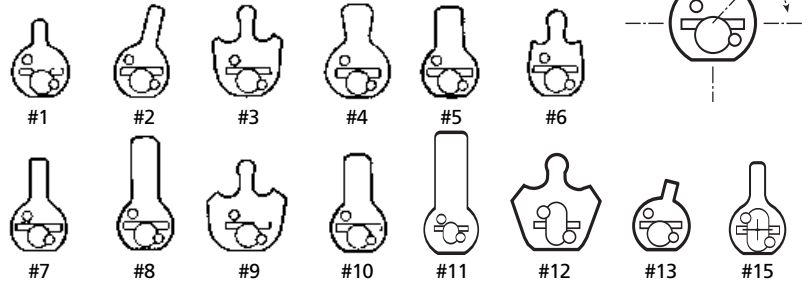

2" Mortise Cylinder

Model/Cam#	Description	HD	HT	BL	BD	R-A	R-B	Comp	Sub	SNS	
Twin Pro											
6158-1	with Adams Rite Cam	1.366	0.138	2.00	1.157	0.118	0.555	175.50	168.00	161.00	
6158-2	with Sargent Cam	1.366	0.138	2.00	1.157	N/A	0.709	175.50	168.00	161.00	
6158-3	with Cor. Clover Leaf Cam	1.366	0.138	2.00	1.157	0.114	0.602	175.50	168.00	161.00	
6158-4	with Cor. Beaver Tail Cam	1.366	0.138	2.00	1.157	N/A	0.732	175.50	168.00	161.00	
6158-5	with Yale Standard Cam	1.366	0.138	2.00	1.157	N/A	0.709	175.50	168.00	161.00	
6158-6	with Schlage "L" Cam	1.366	0.138	2.00	1.157	0.124	0.516	175.50	168.00	161.00	
6158-7	with Segal Type Cam	1.366	0.138	2.00	1.157	N/A	0.779	175.50	168.00	161.00	
6158-8	with Corbin Jumbo Cam	1.366	0.138	2.00	1.157	N/A	0.914	175.50	168.00	161.00	
6158-9	with Best 30H Cam	1.366	0.138	2.00	1.157	0.114	0.602	175.50	168.00	161.00	
6158-10	with Norment/AirTeq Cam	1.366	0.138	2.00	1.157	N/A	0.787	175.50	168.00	161.00	
6158-11	with Mogul Cam	1.366	0.138	2.00	1.157	N/A	1.165	175.50	168.00	161.00	
6158-12	with Cor. Jumbo Clover Leaf	1.366	0.138	2.00	1.157	0.114	0.828	175.50	168.00	161.00	
6158-13	with Sargent Short Cam	1.366	0.138	2.00	1.157	N/A	0.515	175.50	168.00	161.00	
6158-15	with Yale Rep. Cam	1.366	0.138	2.00	1.157	0.742	0.308	175.50	168.00	161.00	
Twin Maximum											
8858-1	with Adams Rite Cam	1.366	0.138	2.00	1.157	0.118	0.555	175.50	168.00	161.00	
8858-2	with Sargent Cam	1.366	0.138	2.00	1.157	N/A	0.709	175.50	168.00	161.00	
8858-3	with Cor. Clover Leaf Cam	1.366	0.138	2.00	1.157	0.114	0.602	175.50	168.00	161.00	
8858-4	with Cor. Beaver Tail Cam	1.366	0.138	2.00	1.157	N/A	0.732	175.50	168.00	161.00	
8858-5	with Yale Standard Cam	1.366	0.138	2.00	1.157	N/A	0.709	175.50	168.00	161.00	
8858-6	with Schlage "L" Cam	1.366	0.138	2.00	1.157	0.124	0.516	175.50	168.00	161.00	
8858-7	with Segal Type Cam	1.366	0.138	2.00	1.157	N/A	0.779	175.50	168.00	161.00	
8858-8	with Corbin Jumbo Cam	1.366	0.138	2.00	1.157	N/A	0.914	175.50	168.00	161.00	
8858-9	with Best 30H Cam	1.366	0.138	2.00	1.157	0.114	0.602	175.50	168.00	161.00	
8858-10	with Norment/AirTeq Cam	1.366	0.138	2.00	1.157	N/A	0.787	175.50	168.00	161.00	
8858-11	with Mogul Cam	1.366	0.138	2.00	1.157	N/A	1.165	175.50	168.00	161.00	
8858-12	w/ Cor. Jumbo Clover Leaf	1.366	0.138	2.00	1.157	0.114	0.828	175.50	168.00	161.00	
8858-13	with Sargent Short Cam	1.366	0.138	2.00	1.157	N/A	0.515	175.50	168.00	161.00	
8858-15	with Yale Rep. Cam	1.366	0.138	2.00	1.157	0.742	0.308	175.50	168.00	161.00	
Twin Low & Twin 600 Series Classic											
Low	600	Description	HD	HT	BL	BD	R-A	R-B	COMP	SUB	—
L658-1	658-1	with Adams Rite Cam	1.366	0.138	2.00	1.157	0.118	0.555	163.00	154.00	—
L658-2	658-2	with Sargent Cam	1.366	0.138	2.00	1.157	N/A	0.709	163.00	154.00	—
L658-3	658-3	with Cor. Clover Leaf Cam	1.366	0.138	2.00	1.157	0.114	0.602	163.00	154.00	—
L658-4	658-4	with Cor. Beaver Tail Cam	1.366	0.138	2.00	1.157	N/A	0.732	163.00	154.00	—
L658-5	658-5	with Yale Standard Cam	1.366	0.138	2.00	1.157	N/A	0.709	163.00	154.00	—
L658-6	658-6	with Schlage "L" Cam	1.366	0.138	2.00	1.157	0.124	0.516	163.00	154.00	—
L658-7	658-7	with Segal Type Cam	1.366	0.138	2.00	1.157	N/A	0.779	163.00	154.00	—
L658-8	658-8	with Corbin Jumbo Cam	1.366	0.138	2.00	1.157	N/A	0.914	163.00	154.00	—
L658-9	658-9	with Best 30H Cam	1.366	0.138	2.00	1.157	0.114	0.602	163.00	154.00	—
L658-10	658-10	with Norment/AirTeq Cam	1.366	0.138	2.00	1.157	N/A	0.787	163.00	154.00	—
L658-11	658-11	with Mogul Cam	1.366	0.138	2.00	1.157	N/A	1.165	163.00	154.00	—
L658-12	658-12	w/ Cor. Jumbo Clover Leaf	1.366	0.138	2.00	1.157	0.114	0.828	163.00	154.00	—
L658-13	658-13	with Sargent Short Cam	1.366	0.138	2.00	1.157	N/A	0.515	163.00	154.00	—
L658-15	658-15	with Yale Rep. Cam	1.366	0.138	2.00	1.157	0.742	0.308	163.00	154.00	—

– Twin Maximum available with CLIQ™ Technology, add \$500.00. Example: 8858-1 x x 626 x Sidebar x Comp

TWIN V-10, TWIN EXCLUSIVE, TWIN PRO, TWIN MAXIMUM, CLIQ

Mortise Cylinders

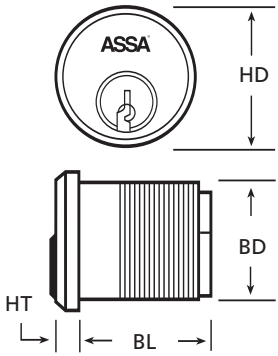

Mortise Cylinder Key:
 HD – Head Diameter
 HT – Head Thickness
 BL – Body Length
 (Includes Cam)
 BD – Body Diameter

Available Cams

Cam Key:
 R-A – Head Radius • R-B – Overall Radius

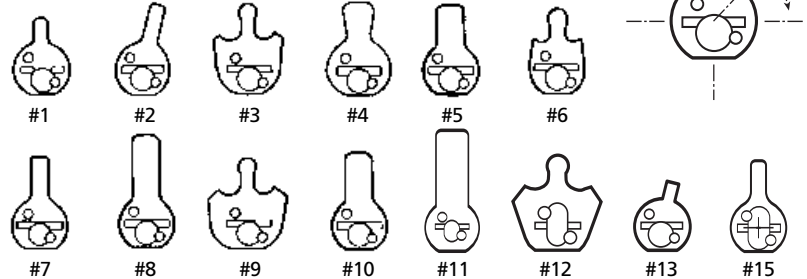

Corbin Jumbo Mortise Cylinder

Model/Cam#	Description	HD	HT	BL	BD	R-A	R-B	Comp	Sub	SNS	
Twin V-10											
† V7551-8	with Corbin Jumbo Cam	1.648	0.138	1.125	1.492	N/A	0.914	151.00	143.50	136.50	
† V7551-12	w/ Cor. Jumbo Clover Cam	1.648	0.138	1.125	1.492	0.114	0.828	151.00	143.50	136.50	
Twin Exclusive											
† E7551-8	with Corbin Jumbo Cam	1.648	0.138	1.125	1.492	N/A	0.914	151.00	143.50	136.50	
† E7551-12	w/ Cor. Jumbo Clover Cam	1.648	0.138	1.125	1.492	0.114	0.828	151.00	143.50	136.50	
Twin 6000 Classic											
† 7551-8	with Corbin Jumbo Cam	1.648	0.138	1.125	1.492	N/A	0.914	128.00	119.00	110.00	
† 7551-12	w/ Cor. Jumbo Clover Cam	1.648	0.138	1.125	1.492	0.114	0.828	128.00	119.00	110.00	
Twin Pro											
† 7151-8	with Corbin Jumbo Cam	1.648	0.138	1.125	1.492	N/A	0.914	151.00	143.50	136.50	
† 7151-12	w/ Cor. Jumbo Clover Cam	1.648	0.138	1.125	1.492	0.114	0.828	151.00	143.50	136.50	
Twin Maximum											
† 7851-8	with Corbin Jumbo Cam	1.648	0.138	1.125	1.492	N/A	0.914	151.00	143.50	136.50	
† 7851-12	w/ Cor. Jumbo Clover Cam	1.648	0.138	1.125	1.492	0.114	0.828	151.00	143.50	136.50	
Twin Low & Twin Low 600 Series Classic											
Low	600	Description	HD	HT	BL	BD	R-A	R-B	COMP	SUB	—
L751-8	751-1	w/ Corbin Jumbo Cam	1.648	0.138	1.125	1.492	N/A	0.914	113.50	104.50	—
L751-12	751-12	w/ Cor. Jumbo Clover Cam	1.648	0.138	1.125	1.492	0.114	0.828	113.50	104.50	—

– Twin Maximum available with CLIQ™ Technology, add \$500.00. Example: 7851-8 x **CLIQ** x 626 x Sidebar x Comp
 † Available in special function cylinders, see page 4, add \$29.00.

TWIN V-10, TWIN EXCLUSIVE, TWIN PRO, TWIN MAXIMUM, CLIQ

Mortise Cylinders

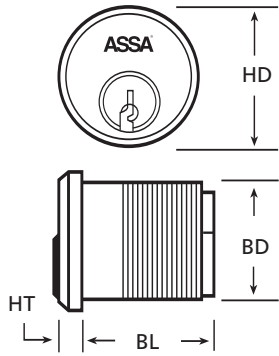

Mortise Cylinder Key:
 HD – Head Diameter
 HT – Head Thickness
 BL – Body Length (Includes Cam)
 BD – Body Diameter

Available Cams

Cam Key:
 R-A – Head Radius • R-B – Overall Radius

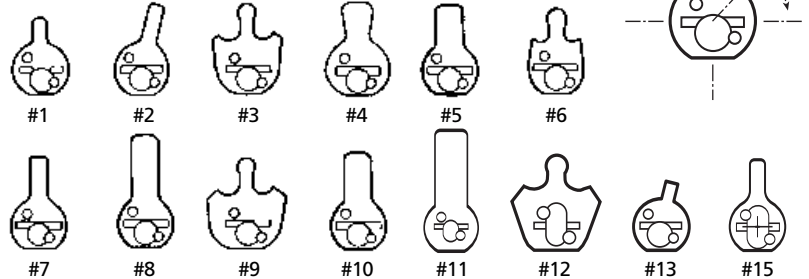

ASSA Segal Cylinder

Model/Cam#	Description	HD	HT	BL	BD	R-A	R-B	Comp	Sub	SNS
Twin V-10										
V6573	Segal inside cyl. with Cam	1.439	0.148	1.377	1.367	N/A	N/A	128.50	120.50	113.50
Twin Exclusive										
E6573	Segal inside cyl. with Cam	1.439	0.148	1.377	1.367	N/A	N/A	128.50	120.50	113.50
Twin 6000 Classic										
6573	Segal inside cyl. with Cam	1.439	0.148	1.377	1.367	N/A	N/A	109.00	99.00	90.00
Twin Pro										
6173	Segal inside cyl. with Cam	1.439	0.148	1.377	1.367	N/A	N/A	128.50	120.50	113.50
Twin Maximum										
8873	Segal inside cyl. with Cam	1.439	0.148	1.377	1.367	N/A	N/A	128.50	120.50	113.50

ASSA Otis Elevator Cylinder

Model/Cam#	Description	HD	HT	BL	BD	R-A	R-B	Comp	Sub	SNS
Twin V-10										
V6551E	Otis Elevator Cylinder	0.595	0.110	1.377	1.157	N/A	N/A	315.00	307.50	300.50
Twin Exclusive										
E6551E	Otis Elevator Cylinder	0.595	0.110	1.377	1.157	N/A	N/A	315.00	307.50	300.50
Twin 6000 Classic										
6551E	Otis Elevator Cylinder	0.595	0.110	1.377	1.157	N/A	N/A	264.50	254.50	246.50
Twin Pro										
6151E	Otis Elevator Cylinder	0.595	0.110	1.377	1.157	N/A	N/A	315.00	307.50	300.50
Twin Maximum										
8851E	Otis Elevator Cylinder	0.595	0.110	1.377	1.157	N/A	N/A	315.00	307.50	300.50

– Twin Maximum available with CLIQ™ Technology, add \$500.00. Example: 8873-1 x **CLIQ** x 626 x Sidebar x Comp

TWIN V-10, TWIN EXCLUSIVE, TWIN PRO, TWIN MAXIMUM, CLIQ

Mortise Component Parts

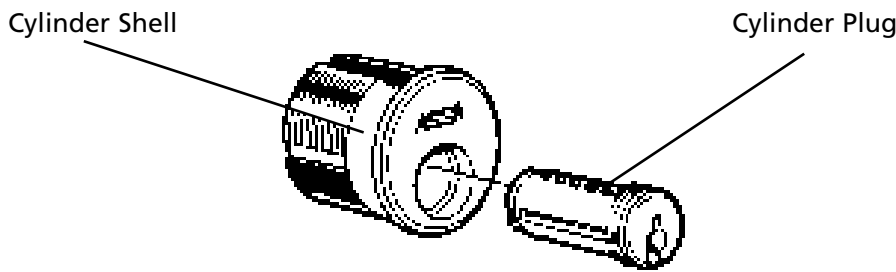

Mortise Cylinder Parts

Model No.	Description	Price
Twin V-10		
867429	1-1/8" Cylinder Shell*	48.50
867430	1-1/4" Cylinder Shell*	48.50
867431	1-3/8" Cylinder Shell*	77.00
867432	1-1/2" Cylinder Shell*	77.50
867433	1-5/8" Cylinder Shell*	80.50
867434	1-3/4" Cylinder Shell*	83.50
867435	1-7/8" Cylinder Shell*	86.00
867436	2" Cylinder Shell*	89.50
807987	Corbin Jumbo 1-1/8" Shell*	97.00
353970	1-1/8" Cylinder Plug*	21.50
353971	1-1/4" Cylinder Plug*	21.50
353972	1-3/8" Cylinder Plug*	24.00
353973	1-1/2" Cylinder Plug*	27.50
353974	1-5/8" Cylinder Plug*	30.00
353975	1-3/4" Cylinder Plug*	32.50
353976	1-7/8" Cylinder Plug*	35.50
353977	2" Cylinder Plug*	38.00
Twin Exclusive		
867429	1-1/8" Cylinder Shell*	48.50
867430	1-1/4" Cylinder Shell*	48.50
867431	1-3/8" Cylinder Shell*	77.00
867432	1-1/2" Cylinder Shell*	77.50
867433	1-5/8" Cylinder Shell*	80.50
867434	1-3/4" Cylinder Shell*	83.50
867435	1-7/8" Cylinder Shell*	86.00
867436	2" Cylinder Shell*	89.50
807987	Corbin Jumbo 1-1/8" Shell*	97.00
367019	1-1/8" Cylinder Plug*	21.50
367020	1-1/4" Cylinder Plug*	21.50
367021	1-3/8" Cylinder Plug*	25.00
367022	1-1/2" Cylinder Plug*	27.50
367023	1-5/8" Cylinder Plug*	30.00
367024	1-3/4" Cylinder Plug*	32.50
367025	1-7/8" Cylinder Plug*	35.50
367026	2" Cylinder Plug*	38.00
907050	Corbin Jumbo Cylinder Thread Adapter	29.00

* – Indicates Finished Components.

TWIN V-10, TWIN EXCLUSIVE, TWIN PRO, TWIN MAXIMUM, CLIQ

Mortise Component Parts

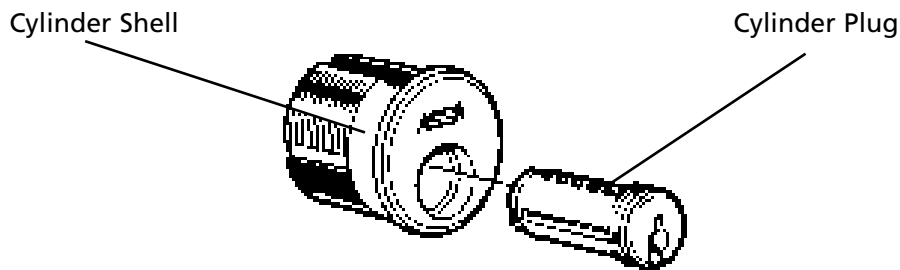

Mortise Cylinder Parts

Model No.	Description	Price
Twin Pro/Twin Maximum		
867429	1-1/8" Cylinder Shell*	48.50
867430	1-1/4" Cylinder Shell*	48.50
867431	1-3/8" Cylinder Shell*	77.00
867432	1-1/2" Cylinder Shell*	77.50
867433	1-5/8" Cylinder Shell*	80.50
867434	1-3/4" Cylinder Shell*	83.50
867435	1-7/8" Cylinder Shell*	86.00
867436	2" Cylinder Shell*	89.50
807987	Corbin Jumbo 1-1/8" Shell*	58.50
356955	1-1/8" Cylinder Plug*†	21.50
356956	1-1/4" Cylinder Plug*†	21.50
356957	1-3/8" Cylinder Plug*†	24.00
356958	1-1/2" Cylinder Plug*†	27.00
356959	1-5/8" Cylinder Plug*†	30.00
356960	1-3/4" Cylinder Plug*†	32.50
356961	1-7/8" Cylinder Plug*†	32.50
356962	2" Cylinder Plug*†	38.00

* – Indicates Finished Components.

† – Specify Profile 0P4 for Twin Pro or 0M7 for Twin Maximum.

TWIN V-10, TWIN EXCLUSIVE, TWIN PRO, TWIN MAXIMUM, CLIQ

High Security Mogul Cylinders

ASSA Mogul cylinders are designed to provide the maximum level of security and durability. Available for ADTEC, Folger Adam, Norment/AirTeq, R.R. Brink, Sargent, and Southern Steel detention locksets, the ASSA Mogul is the smart choice for today's corrections industry. A hardened cover plate and hardened steel inserts in the cylinder shell provide protection against even the most savage and determined forms of physical attack. As with all ASSA high security cylinders, our patented key control ensures the ultimate protection against unauthorized key duplication.



Benefits:

- Hardened plug cover plate to prevent drill attack
- Case-hardened steel inserts and stainless steel pins
- Two independent locking mechanisms to ensure security and optimum pick resistance
- Inactive "false" grooves on side pins designed to enhance pick resistance
- Counter mill in each chamber position to further enhance pick resistance
- Extremely close tolerances
- Can be easily rekeyed in the field

Warranty:

- ASSA guarantees its cylinders against defective workmanship or wear resulting from defects for life

Certification:

- All ASSA Twin Series Mogul cylinders are U.L. 437 listed as well as ASTM F 1577 6.6 Certified for standard test methods for Detention Locks

Technical Information:

- Available in 1-1/8" and 1-1/2" lengths
- Available with limited rotation and/or unidirectional features
- Cylinder housing and plug are made of high quality brass
- Stainless steel top pins
- Bottom pins and master pins are nickel silver

Finishes:

<u>BHMA Symbol</u>	<u>U.S. Symbol</u>	<u>Euro Finish</u>	<u>Description</u>
626	US 26D	13	Satin Chrome
606	US 4	23	Satin Brass

TWIN V-10, TWIN EXCLUSIVE, TWIN PRO, TWIN MAXIMUM, CLIQ

High Security Mogul Cylinders Ordering Information

Model No.

Finish

Program

Security Form

Keyway

V8551-11

626

C2R

Sub

95-300

↑
Contact Customer Service Department For Keyway Numbers.

ASSA 1-1/8" Mogul (N)

Model/Cam#	Description
Twin V-10	
†V8551-11	with Mogul C
†V8551-14	with Sargent
Twin Exclusive	
†E8551-11	with Mogul
†E8551-14	with Sarg

Catalog Page.

The Twin V-10 Cylect C

The V-10 was introduced as an up key profiles. The system consists

C2L	Locally exclusive
C2R	Regionally exclu
C2D	Nationally excl
C2E	Regionally ex

Keyway Information

Each key control program
Various sidebar

General Information Page 3.

FINISHES

Standard finishes are shown below

ASSA	BHMA Symbol
625	
626	
605	
606	
609	
624	
612	

General Information Page 4.

Cylinder Form

ASSA Twin & V-10 locks and cylinders

COMP (Complete)	Keyed-includ
KBC (Key Blank Credit)	Credit
SUB (Sub-assembled)	Unco key
SNS (Sub, No sidebar)	U

Components

General Information Page 3.

How To Order Twin V-10 & Twin Exclusive Mogul Cylinders:

Specify	Model No.	Finish	Security Program	Form	Keyway
Example:	V8551-11	626	C2R	Sub	95-300

TWIN V-10, TWIN EXCLUSIVE, TWIN PRO, TWIN MAXIMUM, CLIQ

High Security Mogul Cylinders Exploded View

1-1/8" Mogul Cylinder

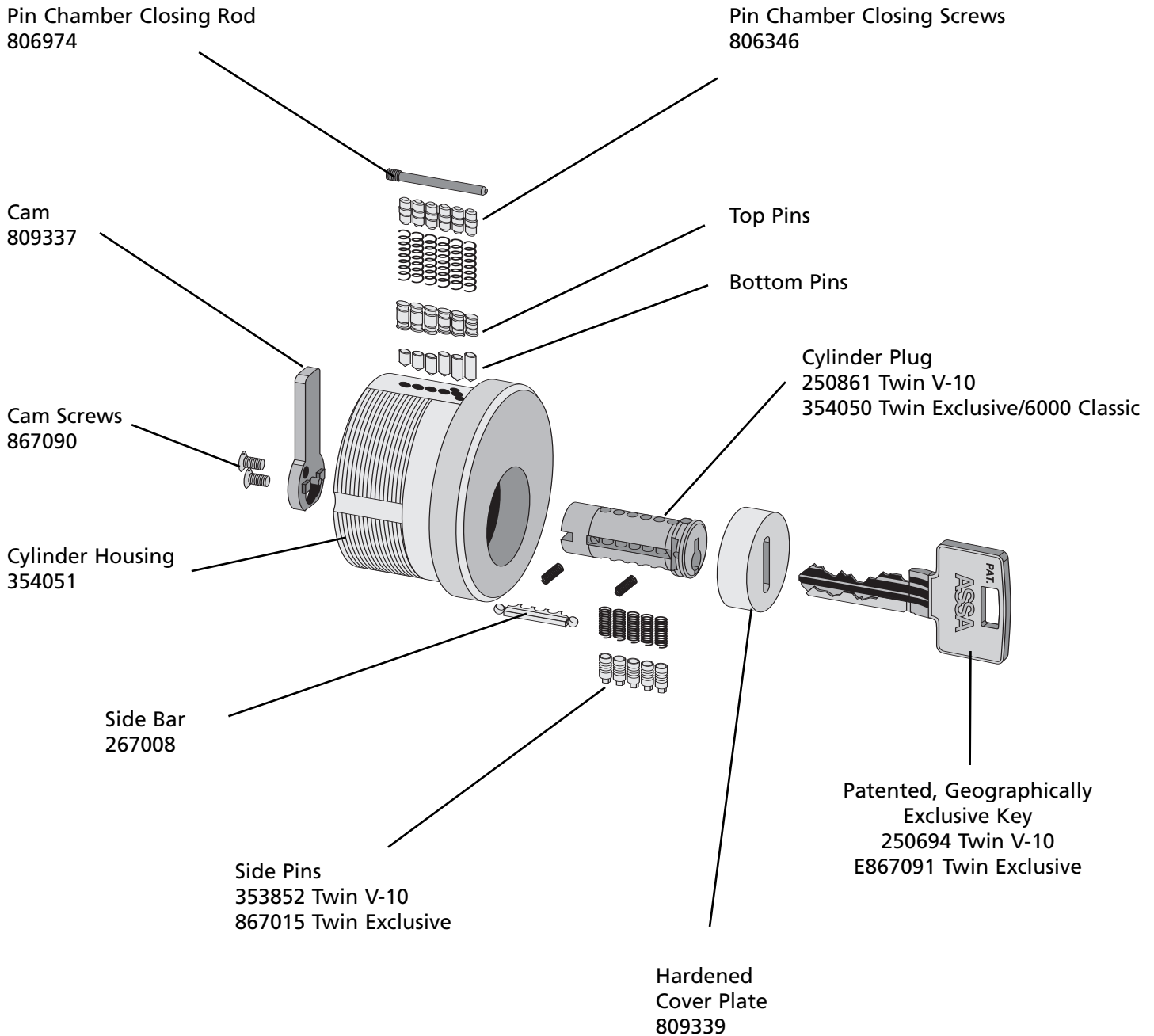

TWIN V-10, TWIN EXCLUSIVE, TWIN PRO, TWIN MAXIMUM, CLIQ

High Security Mogul Cylinders Exploded View

1-1/2" Mogul Cylinder

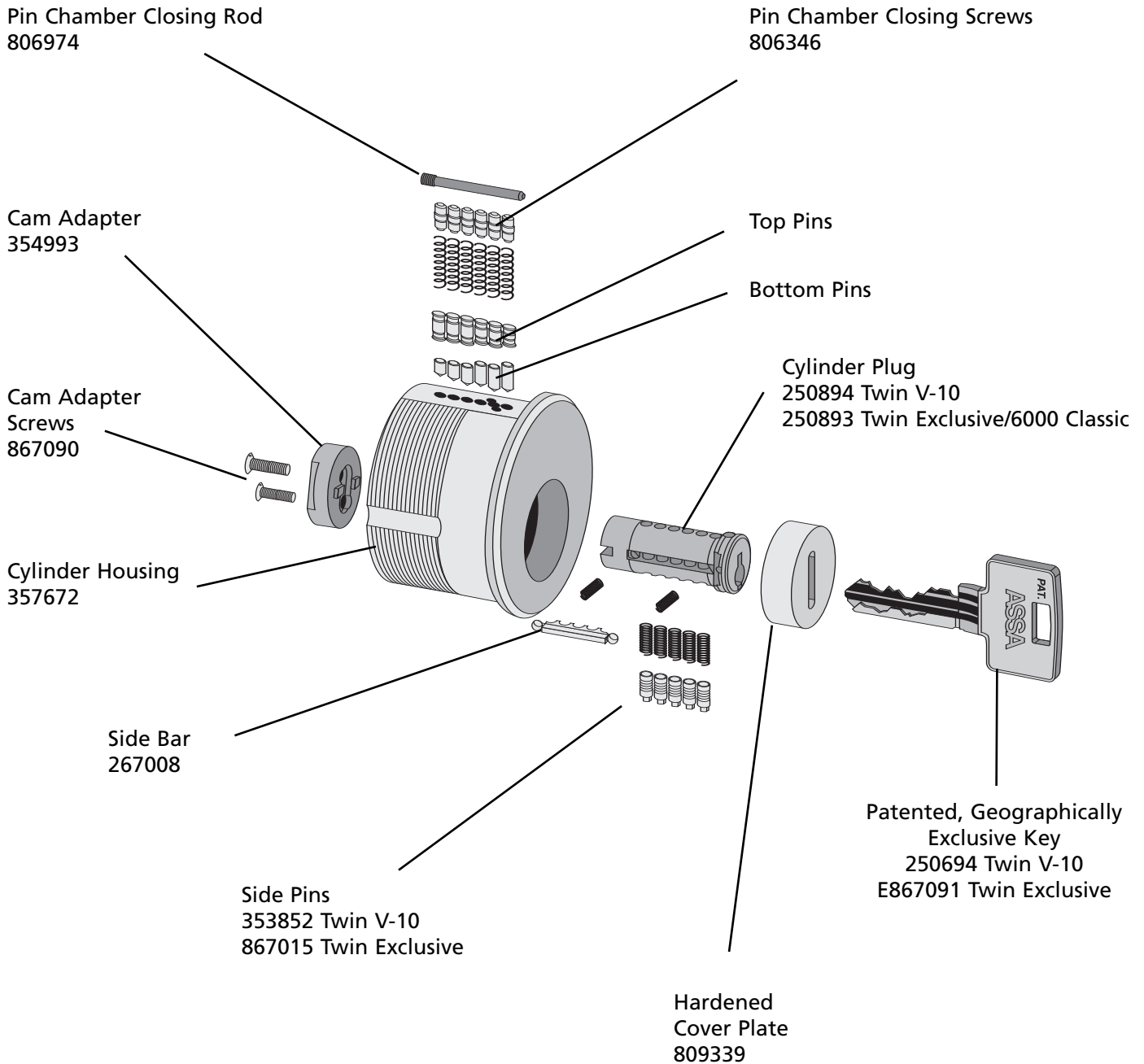

TWIN V-10, TWIN EXCLUSIVE, TWIN PRO, TWIN MAXIMUM, CLIQ

High Security Mogul Cylinders

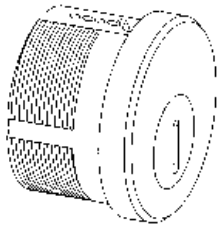

1-1/8" Mogul
AirTeq/Norment

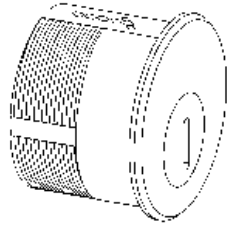

1-1/2" Mogul
SS, FA, NA, BR, AD

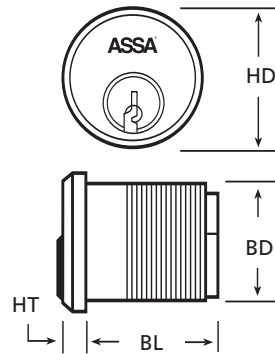
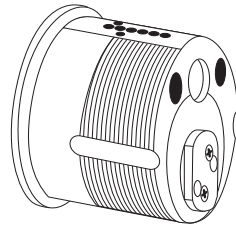

Mortise Cylinder Key:
 HD – Head Diameter
 HT – Head Thickness
 BL – Body Length
 (Includes Cam)
 BD – Body Diameter

Available Cams

Cam Key:
 R-A – Head Radius
 R-B – Overall Radius

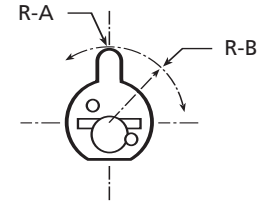

#11



#14

ASSA 1-1/8" Mogul AirTeq/Norment Cylinder

Model/Cam#	Description	HD	HT	BL	BD	R-A	R-B	Comp	Sub	SNS
Twin V-10										
† V8551-11	with Mogul Cam	2.245	0.340	1.260	2.000	N/A	1.165	144.00	136.50	129.50
† V8551-14	with Sargent Mogul Cam	2.245	0.340	1.260	2.000	N/A	1.043	144.00	136.50	129.50
Twin Exclusive										
† E8551-11	with Mogul Cam	2.245	0.340	1.260	2.000	N/A	1.165	144.00	136.50	129.50
† E8551-14	with Sargent Mogul Cam	2.245	0.340	1.260	2.000	N/A	1.043	144.00	136.50	129.50
Twin 6000 Classic										
† 8551-11	with Mogul Cam	2.245	0.340	1.260	2.000	N/A	1.165	164.00	155.00	146.00
† 8551-14	with Sargent Mogul Cam	2.245	0.340	1.260	2.000	N/A	1.043	164.00	155.00	146.00

ASSA 1-1/2" Southern Steel Mogul Cylinder

Model/Cam#	Description	HD	HT	BL	BD	R-A	R-B	Comp	Sub	SNS
Twin V-10										
† V8551SS	shipped without Cams	2.245	0.120	1.590	2.000	N/A	N/A	144.00	136.50	129.50
Twin Exclusive										
† E8551SS	shipped without Cams	2.245	0.120	1.590	2.000	N/A	N/A	144.00	136.50	129.50
Twin 6000 Classic										
† 8551SS	shipped without Cams	2.245	0.120	1.590	2.000	N/A	N/A	164.00	155.00	146.00

No Cams offered for 1-1/2" Mogul cylinders

† Available in special function cylinders, see page 4, add \$29.00.

TWIN V-10, TWIN EXCLUSIVE, TWIN PRO, TWIN MAXIMUM, CLIQ

High Security Mogul Cylinders

ASSA 1-1/2" Folger Adam Mogul Cylinder

Model/Cam#	Description	HD	HT	BL	BD	R-A	R-B	Comp	Sub	SNS
Twin V-10										
† V8551FA	shipped without Cams	2.245	0.120	1.590	2.000	N/A	N/A	144.00	136.50	129.50
Twin Exclusive										
† E8551FA	shipped without Cams	2.245	0.120	1.590	2.000	N/A	N/A	144.00	136.50	129.50
Twin 6000 Classic										
† 8551FA	shipped without Cams	2.245	0.120	1.590	2.000	N/A	N/A	164.00	155.00	146.00

ASSA 1-1/2" Norment/AirTeq Mogul Cylinder

Model/Cam#	Description	HD	HT	BL	BD	R-A	R-B	Comp	Sub	SNS
Twin V-10										
† V8551NA	shipped without Cams	2.245	0.120	1.590	2.000	N/A	N/A	144.00	136.50	129.50
Twin Exclusive										
† E8551NA	shipped without Cams	2.245	0.120	1.590	2.000	N/A	N/A	144.00	136.50	129.50
Twin 6000 Classic										
† 8551NA	shipped without Cams	2.245	0.120	1.590	2.000	N/A	N/A	164.00	155.00	146.00

ASSA 1-1/8" R.R. Brink Mogul Cylinder

Model/Cam#	Description	HD	HT	BL	BD	R-A	R-B	Comp	Sub	SNS
Twin V-10										
† V8551BR	shipped with #11 Cam	2.245	0.120	1.590	2.000	N/A	N/A	144.00	136.50	129.50
Twin Exclusive										
† E8551BR	shipped with #11 Cam	2.245	0.120	1.590	2.000	N/A	N/A	144.00	136.50	129.50
Twin 6000 Classic										
† 8551BR	shipped with #11 Cam	2.245	0.120	1.590	2.000	N/A	N/A	164.00	155.00	146.00

ASSA 1-1/2" ADTECH Mogul Cylinder

Model/Cam#	Description	HD	HT	BL	BD	R-A	R-B	Comp	Sub	SNS
Twin V-10										
† V8551AD	shipped without Cams	2.245	0.120	1.590	2.000	N/A	N/A	144.00	136.50	129.50
Twin Exclusive										
† E8551AD	shipped without Cams	2.245	0.120	1.590	2.000	N/A	N/A	144.00	136.50	129.50
Twin 6000 Classic										
† 8551AD	shipped without Cams	2.245	0.120	1.590	2.000	N/A	N/A	164.00	155.00	146.00

No Cams offered for 1-1/2" Mogul cylinders

† Available in special function cylinders, see page 4, add \$29.00.

TWIN V-10, TWIN EXCLUSIVE, TWIN PRO, TWIN MAXIMUM, CLIQ

High Security IC Mogul Cylinders

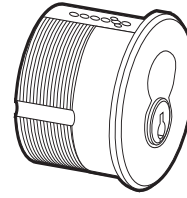
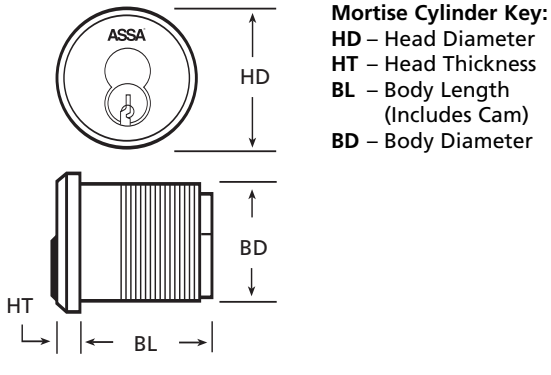

1-1/2" IC Cylinder

ASSA 1-1/2" Southern Steel Interchangeable Core Mogul Cylinder

Model/Cam#	Description	HD	HT	BL	BD	R-A	R-B	Comp	Sub	SNS
Twin V-10										
V8551SSIC	1-1/2" Mogul IC Cylinder	2.245	0.120	1.590	2.000	N/A	N/A	204.50	199.00	192.00
Twin Exclusive										
E8551SSIC	1-1/2" Mogul IC Cylinder	2.245	0.120	1.590	2.000	N/A	N/A	204.50	199.00	192.00
Twin 6000 Classic										
8551SSIC	1-1/2" Mogul IC Cylinder	2.245	0.120	1.590	2.000	N/A	N/A	220.50	211.50	202.50

ASSA 1-1/2" Folger Adam Interchangeable Core Mogul Cylinder

Model/Cam#	Description	HD	HT	BL	BD	R-A	R-B	Comp	Sub	SNS
Twin V-10										
V8551FAIC	1-1/2" Mogul IC Cylinder	2.245	0.120	1.590	2.000	N/A	N/A	204.50	199.00	192.00
Twin Exclusive										
E8551FAIC	1-1/2" Mogul IC Cylinder	2.245	0.120	1.590	2.000	N/A	N/A	204.50	199.00	192.00
Twin 6000 Classic										
8551FAIC	1-1/2" Mogul IC Cylinder	2.245	0.120	1.590	2.000	N/A	N/A	220.50	211.50	202.50

ASSA 1-1/2" Norment/AirTeq Interchangeable Core Mogul Cylinder

Model/Cam#	Description	HD	HT	BL	BD	R-A	R-B	Comp	Sub	SNS
Twin V-10										
V8551NAIC	1-1/2" Mogul IC Cylinder	2.245	0.120	1.590	2.000	N/A	N/A	204.50	199.00	192.00
Twin Exclusive										
E8551NAIC	1-1/2" Mogul IC Cylinder	2.245	0.120	1.590	2.000	N/A	N/A	204.50	199.00	192.00
Twin 6000 Classic										
8551NAIC	1-1/2" Mogul IC Cylinder	2.245	0.120	1.590	2.000	N/A	N/A	220.50	211.50	202.50

TWIN V-10, TWIN EXCLUSIVE, TWIN PRO, TWIN MAXIMUM, CLIQ

High Security IC Mogul Cylinders

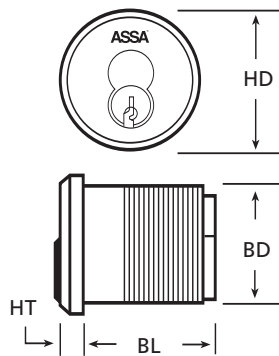

Mortise Cylinder Key:
 HD – Head Diameter
 HT – Head Thickness
 BL – Body Length
 (Includes Cam)
 BD – Body Diameter

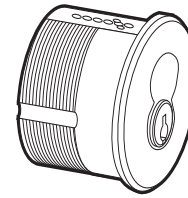

1-1/2" IC Cylinder

ASSA 1-1/2" R.R. Brink Interchangeable Core Mogul Cylinder

Model/Cam#	Description	HD	HT	BL	BD	R-A	R-B	Comp	Sub	SNS
Twin V-10										
V8551BRIC	1-1/2" Mogul IC Cylinder	2.245	0.120	1.590	2.000	N/A	N/A	204.50	199.00	192.00
Twin Exclusive										
E8551BRIC	1-1/2" Mogul IC Cylinder	2.245	0.120	1.590	2.000	N/A	N/A	204.50	199.00	192.00
Twin 6000 Classic										
8551BRIC	1-1/2" Mogul IC Cylinder	2.245	0.120	1.590	2.000	N/A	N/A	220.50	211.50	202.50

ASSA 1-1/2" ADTECH Interchangeable Core Mogul Cylinder

Model/Cam#	Description	HD	HT	BL	BD	R-A	R-B	Comp	Sub	SNS
Twin V-10										
V8551ADIC	1-1/2" Mogul IC Cylinder	2.245	0.120	1.590	2.000	N/A	N/A	204.50	199.00	192.00
Twin Exclusive										
E8551ADIC	1-1/2" Mogul IC Cylinder	2.245	0.120	1.590	2.000	N/A	N/A	204.50	199.00	192.00
Twin 6000 Classic										
8551ADIC	1-1/2" Mogul IC Cylinder	2.245	0.120	1.590	2.000	N/A	N/A	220.50	211.50	202.50

ASSA 1-1/2" Temporary Interchangeable Construction Core Mogul Cylinder

Model #	Description	HD	HT	BL	BD	R-A	R-B	Comp	Sub	SNS
8551SSICR	1-1/2" Mogul IC Cylinder	2.245	0.120	1.590	2.000	N/A	N/A	206.50	—	—
8551FAICR	1-1/2" Mogul IC Cylinder	2.245	0.120	1.590	2.000	N/A	N/A	206.50	—	—
8551NAICR	1-1/2" Mogul IC Cylinder	2.245	0.120	1.590	2.000	N/A	N/A	206.50	—	—
8551BRICR	1-1/2" Mogul IC Cylinder	2.245	0.120	1.590	2.000	N/A	N/A	206.50	—	—
8551ADICR	1-1/2" Mogul IC Cylinder	2.245	0.120	1.590	2.000	N/A	N/A	206.50	—	—

For temporary cores refer to Red Core on page 4.

TWIN V-10, TWIN EXCLUSIVE, TWIN PRO, TWIN MAXIMUM, CLIQ

High Security Mogul Component Parts

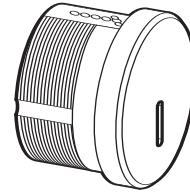
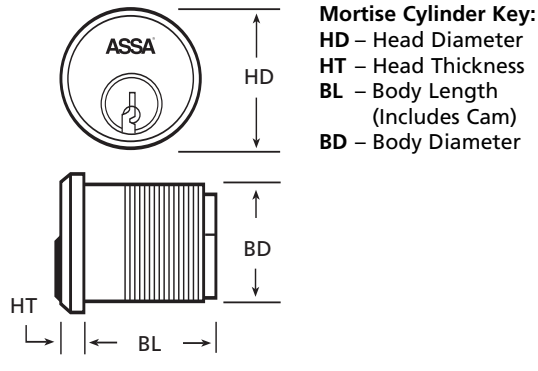

1-1/8" Dummy Cylinder

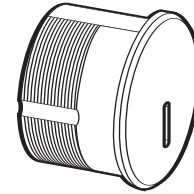

1-1/2" Dummy Cylinder

Mogul Cylinder Parts

Model No.	Description	PRICE
Twin V-10		
354051	1-1/8" Mogul Cylinder Shell	54.50
357672	1-1/2" Mogul Cylinder Shell	56.00
250861	1-1/8" Mogul Cylinder Plug	33.50
250894	1-1/2" Mogul Cylinder Plug	33.50
354993	Cam Adaptor for 1-1/2" Cylinder	9.50
809339	Mogul Cylinder Plug Cover Plate	8.25
907035	Mogul Chamber Screw Wrench	.75
Twin Exclusive		
354051	1-1/8" Mogul Cylinder Shell	54.50
357672	1-1/2" Mogul Cylinder Shell	56.00
354050	1-1/8" Mogul Cylinder Plug	33.50
250893	1-1/2" Mogul Cylinder Plug	33.50
354993	Cam Adaptor for 1-1/2" Cylinder	9.50
809339	Mogul Cylinder Plug Cover Plate	8.25
907035	Mogul Chamber Screw Wrench	.75

ASSA Mogul Dummy Cylinders

Model	Description	HD	HT	BL	BD	R-A	R-B	Price
8551DUM	1-1/8" Mogul Dummy Cylinder	2.245	0.340	1.260	2.00	N/A	N/A	74.00
8551SSDUM	1-1/2" Mogul Dummy Cylinder	2.245	0.120	1.590	2.00	N/A	N/A	74.00

ASSA Mogul Interchangeable Core Housings

Model	Description	HD	HT	BL	BD	R-A	R-B	Price
80601	1-1/8" Mogul IC Housing	2.245	0.340	1.260	2.00	N/A	N/A	129.50
	1-1/2" Mogul IC Housing	2.245	0.120	1.590	2.00	N/A	N/A	129.50

To order Interchangeable Cores separately – see page 62 for details.

TWIN V-10, TWIN EXCLUSIVE, TWIN PRO, TWIN MAXIMUM, CLIQ

Rim Cylinders

Commonly used on apartment and condominium doors, ASSA rim cylinders are used on vertical deadbolt locks and are also designed for commercial exit and panic devices. Available with either horizontal/vertical break-off or lazy-motion type break-off tailpieces, ASSA rim cylinders can be ordered with the standard or the Sargent rim exit device mounting patterns.



The standard rim cylinder can be easily converted to a mortise cylinder by simply replacing the rim tailpiece assembly with the appropriate cam.

Benefits:

- Drill resistant cylinder housing and plug
- Case-hardened steel inserts and stainless steel pins
- Two independent locking mechanisms to ensure security and optimum pick resistance
- Inactive “false” grooves on side pins designed to catch picking tools
- Extremely close tolerances
- Can be easily rekeyed in the field
- Standard and Sargent hole pattern available
- Standard rim cylinder is easily converted to mortise cylinder

Warranty:

- ASSA guarantees its cylinders against defective workmanship or wear resulting from defects for life

Certification:

- All ASSA Twin Series Rim cylinders are U.L. 437 Listed as well as ASTM F 1577 6.6 Certified for standard test methods for Detention Locks

Technical Information:

- Available with limited rotation and/or unidirectional features
- Cylinder housing and plug are made of high quality brass
- Stainless steel top pins
- Bottom pins and master pins are nickel silver

Finishes:

<u>BHMA Symbol</u>	<u>U.S. Symbol</u>	<u>Euro Finish</u>	<u>Description</u>
625	US 26	11	Bright Chrome
626	US 26D	13	Satin Chrome
605	US 3	20	Bright Brass
606	US 4	23	Satin Brass
612	US 10	33	Satin Bronze
624	US 10B	46	Dark Oxidized Bronze

TWIN V-10, TWIN EXCLUSIVE, TWIN PRO, TWIN MAXIMUM, CLIQ

Rim Cylinders Ordering Information

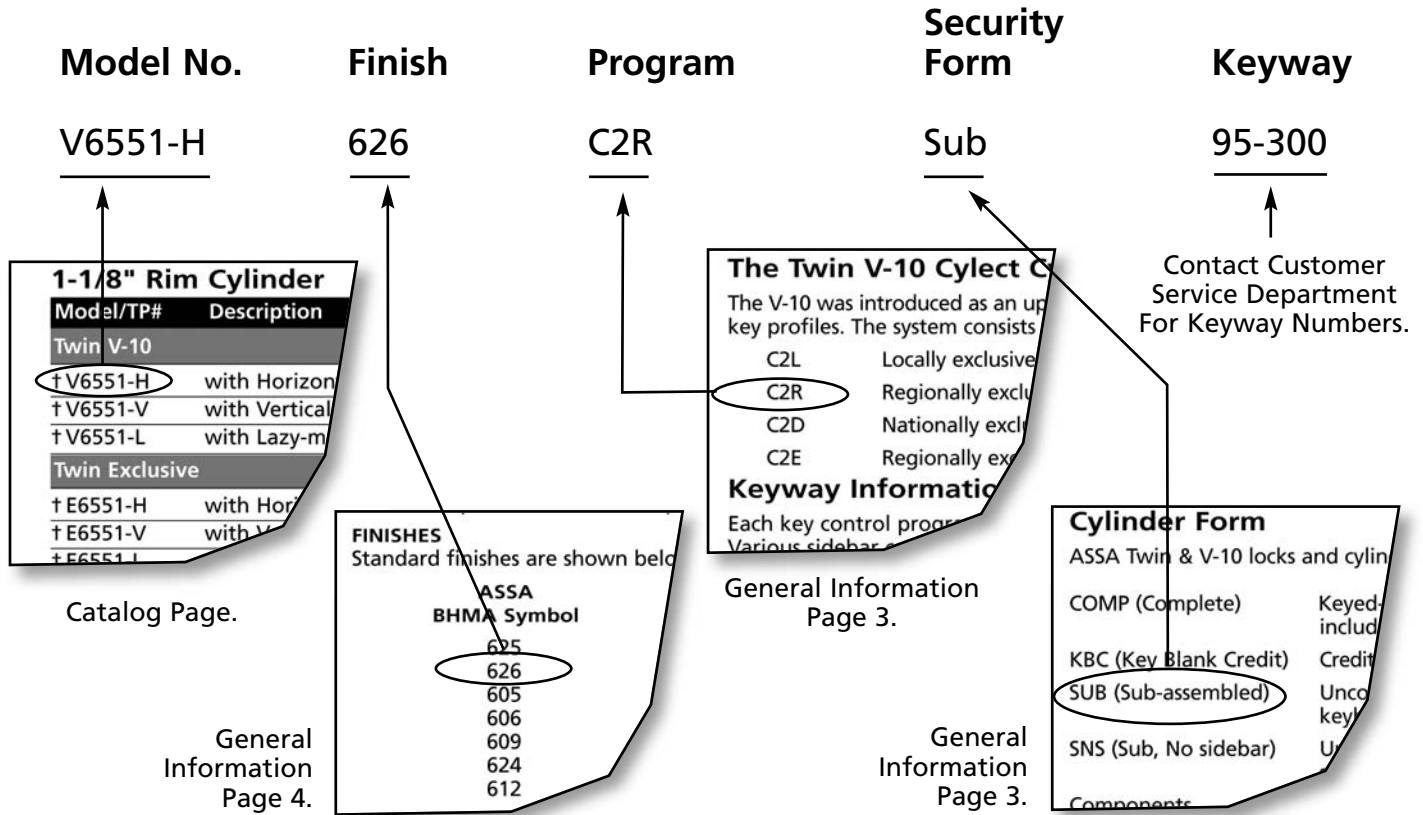

How To Order Rim Cylinders:

Specify	Model No.	Finish	Security Program	Form	Keyway
Example:	V6551-H	626	C2R	Sub	95-300

Rim Cylinder mounting plates, screws included with cylinder. All items available separately below:

Part No.	Description	Price
900210	Rim cylinder mounting plate	1.25 ea
900211	Rim cylinder mounting screws	0.75/pr
900209	Kit, includes plate and 2 screws	1.75 ea
900212	Rim cylinder collar rings (Finish 605, 624 & 626 ONLY)	3.50 ea
867450	Horizontal & Vertical Rim Tailpiece Kit, includes 900209 Kit	16.50 ea
867451	Lazy Motion Rim Tailpiece Kit, includes 900209 Kit	16.50 ea

Aluminum blocking rings, finish 626 or 624 **ONLY**

Part No.	Width	Price
900219	1/4"	3.50 ea
900220	3/8"	3.50 ea
900221	1/2"	3.50 ea

Adjustable collar ring, Item No. 900222, finish 626,605 or 624 **ONLY**, \$6.00

Hardened collar ring, Item No. 900223, finish 626 or 624 **ONLY**, \$11.50

Corbin Jumbo Collar, Item No. 900224, finish 626, **ONLY** \$9.25

TWIN V-10, TWIN EXCLUSIVE, TWIN PRO, TWIN MAXIMUM, CLIQ

Rim Cylinders Exploded View

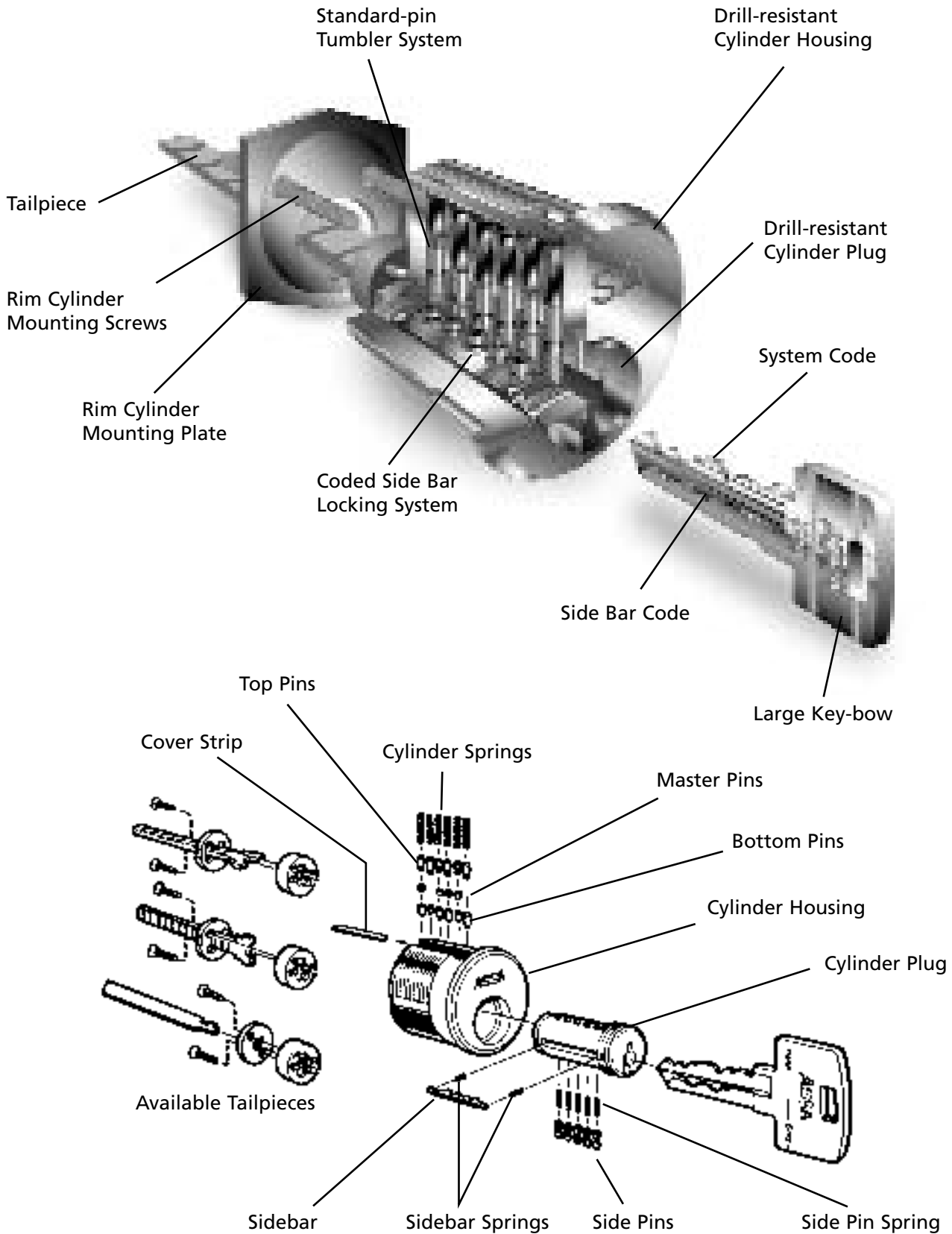

TWIN V-10, TWIN EXCLUSIVE, TWIN PRO, TWIN MAXIMUM, CLIQ

Rim Cylinders

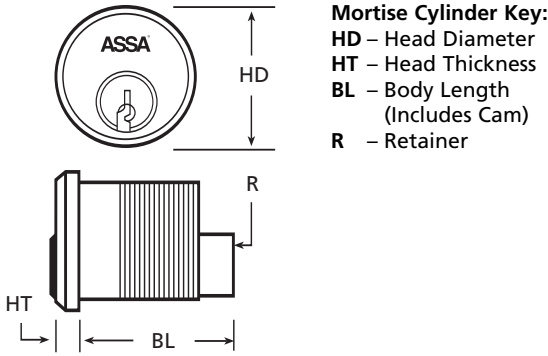

Available Tailpieces



1-1/8" Rim Cylinder

Model/TP#	Description	HD	HT	BL	R	Comp	Sub	SNS	
Twin V-10									
† V6551-H	with Horizontal Tailpiece	1.366	0.138	1.290	0.060	85.00	77.50	70.50	
† V6551-V	with Vertical Tailpiece	1.366	0.138	1.290	0.060	85.00	77.50	70.50	
† V6551-L	with Lazy-motion Tailpiece	1.366	0.138	1.290	0.060	85.00	77.50	70.50	
Twin Exclusive									
† E6551-H	with Horizontal Tailpiece	1.366	0.138	1.290	0.060	85.00	77.50	70.50	
† E6551-V	with Vertical Tailpiece	1.366	0.138	1.290	0.060	85.00	77.50	70.50	
† E6551-L	with Lazy-motion Tailpiece	1.366	0.138	1.290	0.060	85.00	77.50	70.50	
Twin 6000 Classic									
† 6551-H	with Horizontal Tailpiece	1.366	0.138	1.290	0.060	100.00	91.00	82.00	
† 6551-V	with Vertical Tailpiece	1.366	0.138	1.290	0.060	100.00	91.00	82.00	
† 6551-L	with Lazy-motion Tailpiece	1.366	0.138	1.290	0.060	100.00	91.00	82.00	
Twin Pro									
† 6151-H	with Horizontal Tailpiece	1.366	0.138	1.290	0.060	85.00	77.50	70.50	
† 6151-V	with Vertical Tailpiece	1.366	0.138	1.290	0.060	85.00	77.50	70.50	
† 6151-L	with Lazy-motion Tailpiece	1.366	0.138	1.290	0.060	85.00	77.50	70.50	
Twin Maximum									
† 8851-H	with Horizontal Tailpiece	1.366	0.138	1.290	0.060	85.00	77.50	70.50	
† 8851-V	with Vertical Tailpiece	1.366	0.138	1.290	0.060	85.00	77.50	70.50	
† 8851-L	with Lazy-motion Tailpiece	1.366	0.138	1.290	0.060	85.00	77.50	70.50	
Twin Maximum Medium Security									
† 2851-H	with Horizontal Tailpiece	1.366	0.138	1.290	0.060	68.00	62.00	56.50	
† 2851-V	with Vertical Tailpiece	1.366	0.138	1.290	0.060	68.00	62.00	56.50	
† 2851-L	with Lazy-motion Tailpiece	1.366	0.138	1.290	0.060	68.00	62.00	56.50	
Twin Low & Twin Low 600 Series Classic									
Low	600	Description	HD	HT	BL	BD	COMP	SUB	—
L651-H	651-H	with Horizontal Tailpiece	1.366	0.138	1.290	0.060	84.00	75.00	—
L651-V	651-V	with Vertical Tailpiece	1.366	0.138	1.290	0.060	84.00	75.00	—
L651-L	651-L	w/Lazy-motion Tailpiece	1.366	0.138	1.290	0.060	84.00	75.00	—

– Twin Maximum available with CLIQ™ Technology, add \$500.00. Example: 8851-H x **CLIQ** x 626 x Sidebar x Comp
 † Available in special function cylinders, see page 10, add \$29.00.

TWIN V-10, TWIN EXCLUSIVE, TWIN PRO, TWIN MAXIMUM, CLIQ

Rim Cylinders

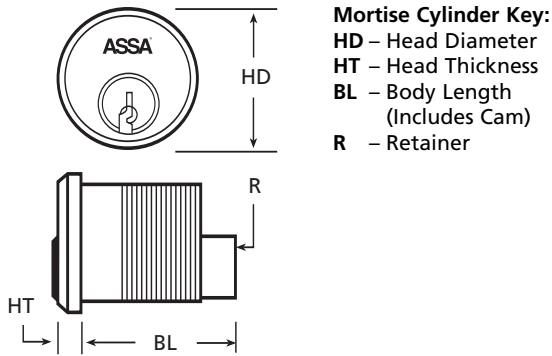

Available Tailpieces



Corbin Jumbo Rim Cylinder

Model/TP#	Description	HD	HT	BL	R	Comp	Sub	SNS	
Twin V-10									
† V7551-H	with Horizontal Tailpiece	1.643	0.170	1.270	0.060	155.50	148.00	141.00	
† V7551-V	with Vertical Tailpiece	1.643	0.170	1.270	0.060	155.50	148.00	141.00	
† V7551-L	with Lazy-motion Tailpiece	1.643	0.170	1.270	0.060	155.50	148.00	141.00	
Twin Exclusive									
† E7551-H	with Horizontal Tailpiece	1.643	0.170	1.270	0.060	155.50	148.00	141.00	
† E7551-V	with Vertical Tailpiece	1.643	0.170	1.270	0.060	155.50	148.00	141.00	
† E7551-L	with Lazy-motion Tailpiece	1.643	0.170	1.270	0.060	155.50	148.00	141.00	
Twin 6000 Classic									
† 7551-H	with Horizontal Tailpiece	1.643	0.170	1.270	0.060	137.50	128.50	119.50	
† 7551-V	with Vertical Tailpiece	1.643	0.170	1.270	0.060	137.50	128.50	119.50	
† 7551-L	with Lazy-motion Tailpiece	1.643	0.170	1.270	0.060	137.50	128.50	119.50	
Twin Pro									
† 7151-H	with Horizontal Tailpiece	1.643	0.170	1.270	0.060	155.50	148.00	141.00	
† 7151-V	with Vertical Tailpiece	1.643	0.170	1.270	0.060	155.50	148.00	141.00	
† 7151-L	with Lazy-motion Tailpiece	1.643	0.170	1.270	0.060	155.50	148.00	141.00	
Twin Maximum									
† 7851-H	with Horizontal Tailpiece	1.643	0.170	1.270	0.060	155.50	148.00	141.00	
† 7851-V	with Vertical Tailpiece	1.643	0.170	1.270	0.060	155.50	148.00	141.00	
† 7851-L	with Lazy-motion Tailpiece	1.643	0.170	1.270	0.060	155.50	148.00	141.00	
Twin Low & Twin Low 600 Series Classic									
Low	600	Description	HD	HT	BL	BD	COMP	SUB	—
L651-H	651-H	with Horizontal Tailpiece	1.643	0.170	1.270	0.060	121.00	112.00	—
L651-V	651-V	with Vertical Tailpiece	1.643	0.170	1.270	0.060	121.00	112.00	—
L651-L	651-L	w/Lazy-motion Tailpiece	1.643	0.170	1.270	0.060	121.00	112.00	—

– Twin Maximum available with CLIQ™ Technology, add \$500.00. Example: 7851-H x **CLIQ** x 626 x Sidebar x Comp
 † Available in special function cylinders, see page 10, add \$29.00.

TWIN V-10, TWIN EXCLUSIVE, TWIN PRO, TWIN MAXIMUM, CLIQ

Rim Cylinders

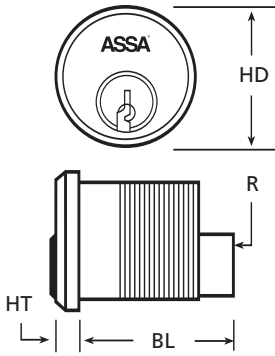

Mortise Cylinder Key:
 HD – Head Diameter
 HT – Head Thickness
 BL – Body Length
 (Includes Cam)
 R – Retainer

Available Tailpieces

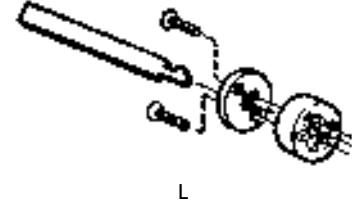
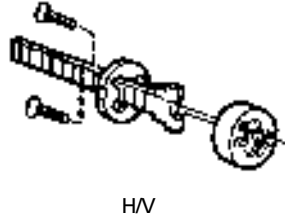

ASSA Mogul (Detention) Cylinders

Model/TP#	Description	HD	HT	BL	R	Comp	Sub	SNS
Twin V-10								
† V8551-H	with Horizontal Tailpiece	2.245	0.340	1.425	0.060	166.50	159.00	152.00
† V8551-V	with Vertical Tailpiece	2.245	0.340	1.425	0.060	166.50	159.00	152.00
† V8551-L	with Lazy-motion Tailpiece	2.245	0.340	1.425	0.060	166.50	159.00	152.00
Twin Exclusive								
† E8551-H	with Horizontal Tailpiece	2.245	0.340	1.425	0.060	166.50	159.00	152.00
† E8551-V	with Vertical Tailpiece	2.245	0.340	1.425	0.060	166.50	159.00	152.00
† E8551-L	with Lazy-motion Tailpiece	2.245	0.340	1.425	0.060	166.50	159.00	152.00
Twin 6000 Classic								
† 8551-H	with Horizontal Tailpiece	2.245	0.340	1.425	0.060	189.00	180.00	171.00
† 8551-V	with Vertical Tailpiece	2.245	0.340	1.425	0.060	189.00	180.00	171.00
† 8551-L	with Lazy-motion Tailpiece	2.245	0.340	1.425	0.060	189.00	180.00	171.00

TWIN V-10, TWIN EXCLUSIVE, TWIN PRO, TWIN MAXIMUM, CLIQ

Rim Cylinders

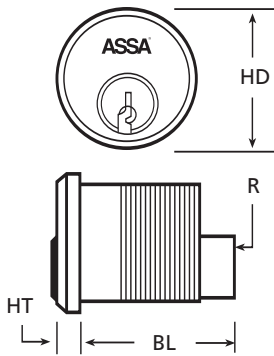

Mortise Cylinder Key:
 HD – Head Diameter
 HT – Head Thickness
 BL – Body Length
 (Includes Cam)
 R – Retainer

Available Tailpieces



Special SARGENT Cylinders (Drilled for SARGENT Devices)

Model/TP#	Description	HD	HT	BL	R	Comp	Sub	SNS	
Twin V-10									
† VS6551-H	with Horizontal Tailpiece	1.366	0.138	1.290	0.060	101.50	93.50	86.50	
† VS6551-V	with Vertical Tailpiece	1.366	0.138	1.290	0.060	101.50	93.50	86.50	
† VS6551-L	with Lazy-motion Tailpiece	1.366	0.138	1.290	0.060	101.50	93.50	86.50	
Twin Exclusive									
† ES6551-H	with Horizontal Tailpiece	1.366	0.138	1.290	0.060	101.50	93.50	86.50	
† ES6551-V	with Vertical Tailpiece	1.366	0.138	1.290	0.060	101.50	93.50	86.50	
† ES6551-L	with Lazy-motion Tailpiece	1.366	0.138	1.290	0.060	101.50	93.50	86.50	
Twin 6000 Classic									
† S6551-H	with Horizontal Tailpiece	1.366	0.138	1.290	0.060	119.00	109.00	100.00	
† S6551-V	with Vertical Tailpiece	1.366	0.138	1.290	0.060	119.00	109.00	100.00	
† S6551-L	with Lazy-motion Tailpiece	1.366	0.138	1.290	0.060	119.00	109.00	100.00	
Twin Pro									
† S6151-H	with Horizontal Tailpiece	1.366	0.138	1.290	0.060	101.50	93.50	86.50	
† S6151-V	with Vertical Tailpiece	1.366	0.138	1.290	0.060	101.50	93.50	86.50	
† S6151-L	with Lazy-motion Tailpiece	1.366	0.138	1.290	0.060	101.50	93.50	86.50	
Twin Maximum									
† S8851-H	with Horizontal Tailpiece	1.366	0.138	1.290	0.060	101.50	93.50	86.50	
† S8851-V	with Vertical Tailpiece	1.366	0.138	1.290	0.060	101.50	93.50	86.50	
† S8851-L	with Lazy-motion Tailpiece	1.366	0.138	1.290	0.060	101.50	93.50	86.50	
Twin Low & Twin Low 600 Series Classic									
Low	600	Description	HD	HT	BL	BD	COMP	SUB	—
LS651-H	S651-H	with Horizontal Tailpiece	1.366	0.138	1.290	0.060	102.00	93.00	—
LS651-V	S651-V	with Vertical Tailpiece	1.366	0.138	1.290	0.060	102.00	93.00	—
LS651-L	S651-L	w/Lazy-motion Tailpiece	1.366	0.138	1.290	0.060	102.00	93.00	—

– Twin Maximum available with CLIQ™ Technology, add \$500.00. Example: S8851-H x **CLIQ** x 626 x Sidebar x Comp
 † Available in special function cylinders, see page 10, add \$29.00.

TWIN V-10, TWIN EXCLUSIVE, TWIN PRO, TWIN MAXIMUM, CLIQ

Rim Component Parts

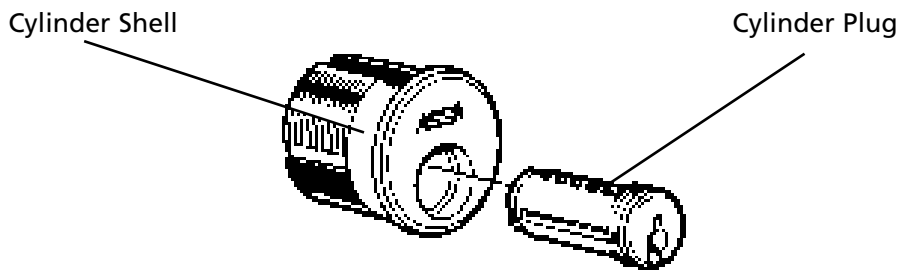

Rim Cylinder Parts

Model No.	Description	Price
Twin V-10		
354947	SARGENT Drilled Rim Shell*	76.50
867429	1-1/8" Cylinder Shell*	48.50
807987	Corbin Jumbo 1-1/8" Shell*	58.50
353970	1-1/8" Cylinder Plug*	21.50
Twin Exclusive		
354947	SARGENT Drilled Rim Shell*	76.50
867429	1-1/8" Cylinder Shell*	48.50
807987	Corbin Jumbo 1-1/8" Shell*	58.50
367019	1-1/8" Cylinder Plug*	21.50
Twin Pro/Twin Maximum		
354947	SARGENT Drilled Rim Shell*	76.50
867429	1-1/8" Cylinder Shell*	48.50
807987	Corbin Jumbo 1-1/8" Shell*	58.50
356955	1-1/8" Cylinder Plug*†	21.50

* – Indicates Finished Components.

† – Specify Profile 0P4 for Twin Pro or 0M7 for Twin Maximum.

TWIN V-10, TWIN EXCLUSIVE, TWIN PRO, TWIN MAXIMUM, CLIQ

Mortise and Rim Interchangeable Core Cylinders

Designed with both security and convenience in mind, the ASSA Large Format Interchangeable core cylinder is perfect for apartment buildings, dormitories, classrooms, and other applications requiring instant rekeying capabilities. This versatile cylinder is adaptable to a wide variety of manufacturers' locksets including the ASSA Number 2 padlock and ASSA 6000 deadbolt series and can be integrated into master keyed systems that use both standard and interchangeable cylinders. Available in the standard ASSA large format as well as the Schlage, Yale 6 pin, and Sargent 6 pin large formats, all ASSA Interchangeable core cylinders are listed under U.L. 437, a set of tests for determining the cylinder's physical resistance against various forms of attack and performance that features our patented key control ensuring the maximum protection from unauthorized key duplication.

**Benefits:**

- Easily rekeyed openings in the field
- Can be used in master key system with standard locks
- Available in multiple manufacturers' formats
- Drill resistant cylinder housing and plug
- Case-hardened steel inserts and stainless steel pins
- Two independent locking mechanisms to ensure security and optimum pick resistance
- Inactive "false" grooves on side pins designed to catch picking tools

Warranty:

- ASSA guarantees its cylinders against defective workmanship or wear resulting from defects for life

Certification:

- All ASSA Interchangeable Core cylinders are U.L. 437 Listed as well as ASTM F 1577 6.6 Certified for standard test methods for Detention Locks

Technical Information

- Available for 1-1/4" mortise and rim cylinders
- Build up pins in first four positions operate control feature
- Cylinder housing and interchangeable core are made of high quality brass
- Stainless steel top pins
- Bottom pins and master pins are nickel silver

Finishes:

BHMA Symbol	U.S. Symbol	Euro Finishes	Description
625	US 26	11	Bright Chrome
626	US 26D	13	Satin Chrome
605	US 3	20	Bright Brass
606	US 4	23	Satin Brass
612	US 10	33	Satin Bronze
624	US 10B	46	Dark Oxidized Bronze

TWIN V-10, TWIN EXCLUSIVE, TWIN PRO, TWIN MAXIMUM, CLIQ

Mortise and Rim Interchangeable Core Cylinders Ordering Information

Model No.

Finish

Program

Security Form

Keyway

V6552IC-1

626

C2R

Sub

95-300

Contact Customer Service Department For Keyway Numbers.

1-1/4" Mortise Cylinder

Mod/Cam#	Description
Twin V-10	
V6552IC-1	with Adams Rite Cam
V6552IC-2	with Sargent Cam
V6552IC-3	with Cor. Clover Leaf
V6552IC-4	with Cor. Beaver Tail
V6552IC-5	with Yale Standard
V6552IC-6	with Schlage "L"
V6552IC-7	with Segal Type
V6552IC-8	with Corbin
V6552IC-9	with

Catalog Page.

The Twin V-10 Cylect C

The V-10 was introduced as an up key profiles. The system consists

C2L	Locally exclusive
C2R	Regionally exclusive
C2D	Nationally exclusive
C2E	Regionally exclusive

Keyway Information

Each key control program
Various sidebar

General Information Page 3.

FINISHES

Standard finishes are shown below

ASSA	BHMA Symbol
625	
626	
605	
606	
609	
624	
612	

General Information Page 4.

Cylinder Form

ASSA Twin & V-10 locks and cylinders

COMP (Complete)	Keyed-included
KBC (Key Blank Credit)	Credit key
SUB (Sub-assembled)	Unco-keyed
SNS (Sub, No sidebar)	U

Components

General Information Page 3.

How To Order Twin V-10, Twin Exclusive Mortise and Rim IC Cylinders:

Specify	Model No.	Finish	Security Program	Form	Keyway
Example:	V6552IC-1	626	C2R	Sub	95-300

How To Order Twin Pro and Twin Maximum Mortise and Rim IC Cylinders:

Specify	Model No.	Finish	Form	Keyway
Example:	6152IC-H	605	Comp	0P4-200

TWIN V-10, TWIN EXCLUSIVE, TWIN PRO, TWIN MAXIMUM, CLIQ

Mortise and Rim Interchangeable Core Cylinders Exploded View

ASSA Interchangeable Core

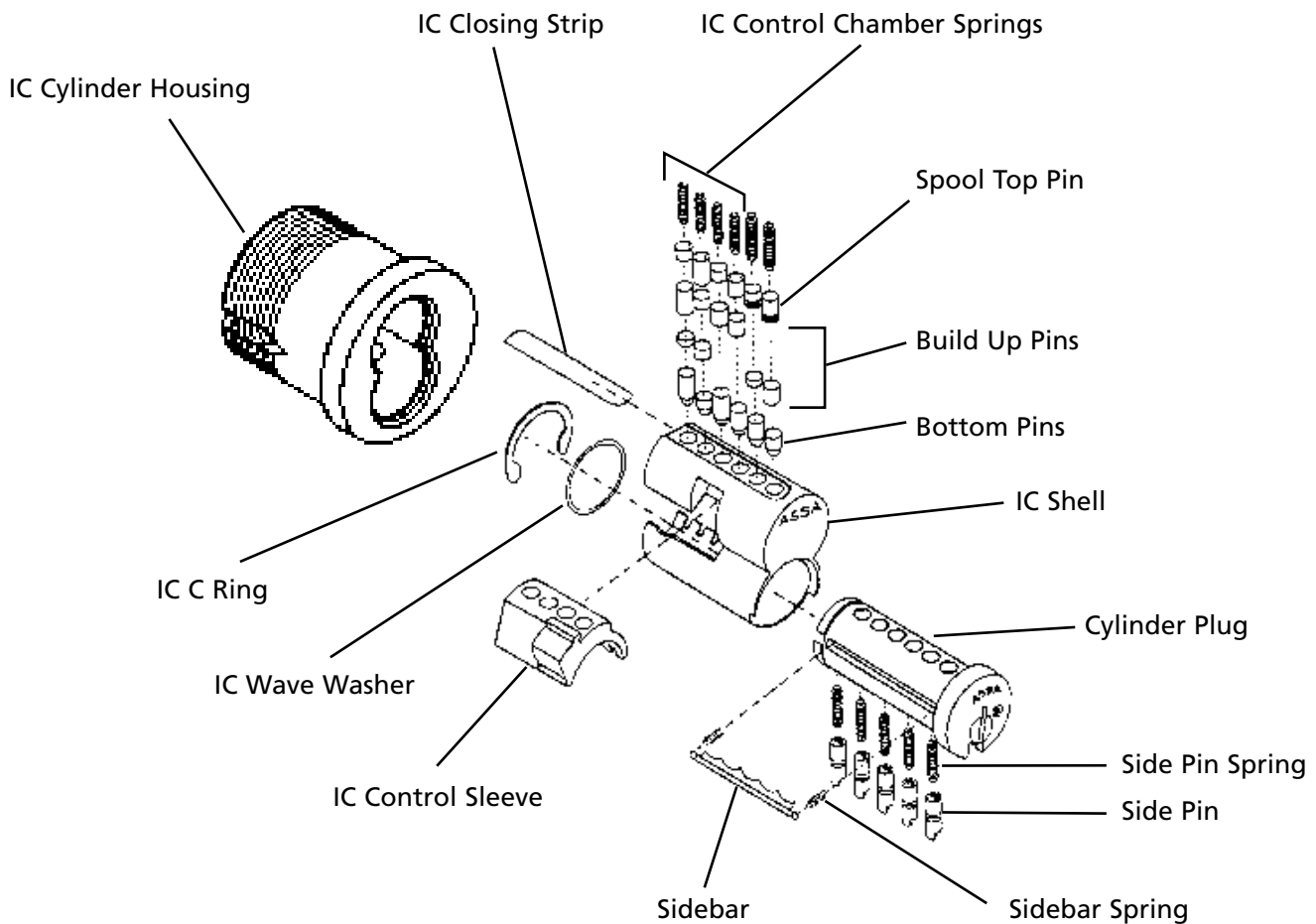

TWIN V-10, TWIN EXCLUSIVE, TWIN PRO, TWIN MAXIMUM, CLIQ

Mortise and Rim IC Cylinders

Mortise Cylinder Key:

HD – Head Diameter • **HT** – Head Thickness
BL – Body Length (Includes Cam) • **BD** – Body Diameter
BH – Body Height • **BW** – Body Width • **R** – Retainer
CBL – IC Core Body Length

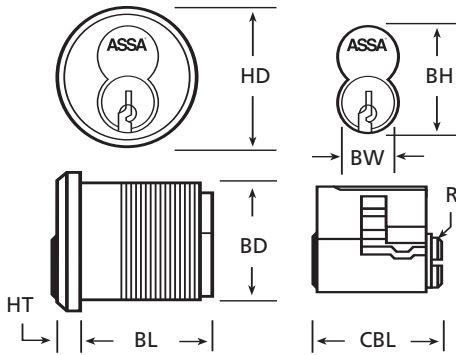

Available Cams

Cam Key:

R-A – Head Radius • **R-B** – Overall Radius

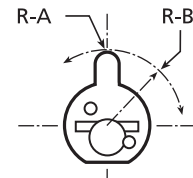
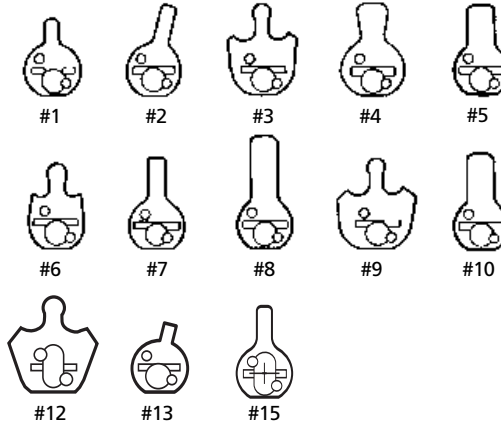

Tailpieces

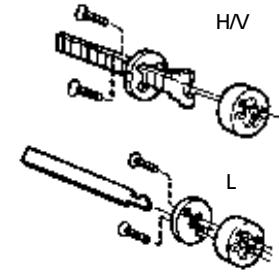

1-1/4" Mortise Cylinder

Mod/Cam#	Description	HD	HT	BL	BD	BH	BW	CBL	R	R-A	R-B	Comp	Sub	SNS
Twin V-10														
V6552IC-1	with Adams Rite Cam	1.366	0.175	1.125	1.157	1.055	0.655	1.247	0.036	0.118	0.555	120.50	113.00	106.00
V6552IC-2	with Sargent Cam	1.366	0.175	1.125	1.157	1.055	0.655	1.247	0.036	N/A	0.709	120.50	113.00	106.00
V6552IC-3	with Cor. Clover Leaf Cam	1.366	0.175	1.125	1.157	1.055	0.655	1.247	0.036	0.114	0.602	120.50	113.00	106.00
V6552IC-4	with Cor. Beaver Tail Cam	1.366	0.175	1.125	1.157	1.055	0.655	1.247	0.036	N/A	0.732	120.50	113.00	106.00
V6552IC-5	with Yale Standard Cam	1.366	0.175	1.125	1.157	1.055	0.655	1.247	0.036	N/A	0.709	120.50	113.00	106.00
V6552IC-6	with Schlage "L" Cam	1.366	0.175	1.125	1.157	1.055	0.655	1.247	0.036	0.124	0.516	120.50	113.00	106.00
V6552IC-7	with Segal Type Cam	1.366	0.175	1.125	1.157	1.055	0.655	1.247	0.036	N/A	0.779	120.50	113.00	106.00
V6552IC-8	with Corbin Jumbo Cam	1.366	0.175	1.125	1.157	1.055	0.655	1.247	0.036	N/A	0.914	120.50	113.00	106.00
V6552IC-9	with Best 30H Cam	1.366	0.175	1.125	1.157	1.055	0.655	1.247	0.036	0.114	0.602	120.50	113.00	106.00
V6552IC-10	with Norment/AirTeq Cam	1.366	0.175	1.125	1.157	1.055	0.655	1.247	0.036	N/A	0.787	120.50	113.00	106.00
V6552IC-12	with Cor. Jumbo Clover Leaf	1.366	0.175	1.125	1.157	1.055	0.655	1.247	0.036	0.114	0.828	120.50	113.00	106.00
V6552IC-13	with Sargent Short Cam	1.366	0.175	1.125	1.157	1.055	0.655	1.247	0.036	N/A	0.515	120.50	113.00	106.00
V6552IC-15	with Yale Rep. Cam	1.366	0.175	1.125	1.157	1.055	0.655	1.247	0.036	0.742	0.308	120.50	113.00	106.00
Twin Exclusive														
E6552IC-1	with Adams Rite Cam	1.366	0.175	1.125	1.157	1.055	0.655	1.247	0.036	0.118	0.555	120.50	113.00	106.00
E6552IC-2	with Sargent Cam	1.366	0.175	1.125	1.157	1.055	0.655	1.247	0.036	N/A	0.709	120.50	113.00	106.00
E6552IC-3	with Cor. Clover Leaf Cam	1.366	0.175	1.125	1.157	1.055	0.655	1.247	0.036	0.114	0.602	120.50	113.00	106.00
E6552IC-4	with Cor. Beaver Tail Cam	1.366	0.175	1.125	1.157	1.055	0.655	1.247	0.036	N/A	0.732	120.50	113.00	106.00
E6552IC-5	with Yale Standard Cam	1.366	0.175	1.125	1.157	1.055	0.655	1.247	0.036	N/A	0.709	120.50	113.00	106.00
E6552IC-6	with Schlage "L" Cam	1.366	0.175	1.125	1.157	1.055	0.655	1.247	0.036	0.124	0.516	120.50	113.00	106.00
E6552IC-7	with Segal Type Cam	1.366	0.175	1.125	1.157	1.055	0.655	1.247	0.036	N/A	0.779	120.50	113.00	106.00
E6552IC-8	with Corbin Jumbo Cam	1.366	0.175	1.125	1.157	1.055	0.655	1.247	0.036	N/A	0.914	120.50	113.00	106.00
E6552IC-9	with Best 30H Cam	1.366	0.175	1.125	1.157	1.055	0.655	1.247	0.036	0.114	0.602	120.50	113.00	106.00
E6552IC-10	with Norment/AirTeq Cam	1.366	0.175	1.125	1.157	1.055	0.655	1.247	0.036	N/A	0.787	120.50	113.00	106.00
E6552IC-12	with Cor. Jumbo Clover Leaf	1.366	0.175	1.125	1.157	1.055	0.655	1.247	0.036	0.114	0.828	120.50	113.00	106.00
E6552IC-13	with Sargent Short Cam	1.366	0.175	1.125	1.157	1.055	0.655	1.247	0.036	N/A	0.515	120.50	113.00	106.00
E6552IC-15	with Yale Rep. Cam	1.366	0.175	1.125	1.157	1.055	0.655	1.247	0.036	0.742	0.308	120.50	113.00	106.00
Twin 6000 Classic														
6552IC-1	with Adams Rite Cam	1.366	0.175	1.125	1.157	1.055	0.655	1.247	0.036	0.118	0.555	142.00	132.00	124.00
6552IC-2	with Sargent Cam	1.366	0.175	1.125	1.157	1.055	0.655	1.247	0.036	N/A	0.709	142.00	132.00	124.00
6552IC-3	with Cor. Clover Leaf Cam	1.366	0.175	1.125	1.157	1.055	0.655	1.247	0.036	0.114	0.602	142.00	132.00	124.00
6552IC-4	with Cor. Beaver Tail Cam	1.366	0.175	1.125	1.157	1.055	0.655	1.247	0.036	N/A	0.732	142.00	132.00	124.00
6552IC-5	with Yale Standard Cam	1.366	0.175	1.125	1.157	1.055	0.655	1.247	0.036	N/A	0.709	142.00	132.00	124.00
6552IC-6	with Schlage "L" Cam	1.366	0.175	1.125	1.157	1.055	0.655	1.247	0.036	0.124	0.516	142.00	132.00	124.00
6552IC-7	with Segal Type Cam	1.366	0.175	1.125	1.157	1.055	0.655	1.247	0.036	N/A	0.779	142.00	132.00	124.00
6552IC-8	with Corbin Jumbo Cam	1.366	0.175	1.125	1.157	1.055	0.655	1.247	0.036	N/A	0.914	142.00	132.00	124.00
6552IC-9	with Best 30H Cam	1.366	0.175	1.125	1.157	1.055	0.655	1.247	0.036	0.114	0.602	142.00	132.00	124.00
6552IC-10	with Norment/AirTeq Cam	1.366	0.175	1.125	1.157	1.055	0.655	1.247	0.036	N/A	0.787	142.00	132.00	124.00
6552IC-12	with Cor. Jumbo Clover Leaf	1.366	0.175	1.125	1.157	1.055	0.655	1.247	0.036	0.114	0.828	142.00	132.00	124.00
6552IC-13	with Sargent Short Cam	1.366	0.175	1.125	1.157	1.055	0.655	1.247	0.036	N/A	0.515	142.00	132.00	124.00
6552IC-15	with Yale Rep. Cam	1.366	0.175	1.125	1.157	1.055	0.655	1.247	0.036	0.742	0.308	142.00	132.00	124.00

For temporary cores refer to Red Core on page 4.

TWIN V-10, TWIN EXCLUSIVE, TWIN PRO, TWIN MAXIMUM, CLIQ

Mortise and Rim IC Cylinders

Mortise Cylinder Key:

HD – Head Diameter • HT – Head Thickness
 BL – Body Length (Includes Cam) • BD – Body Diameter
 BH – Body Height • BW – Body Width • R – Retainer
 CBL – IC Core Body Length

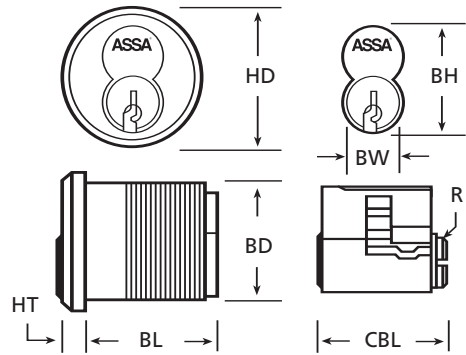

Available Cams

Cam Key:

R-A – Head Radius • R-B – Overall Radius

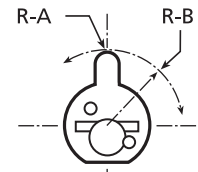
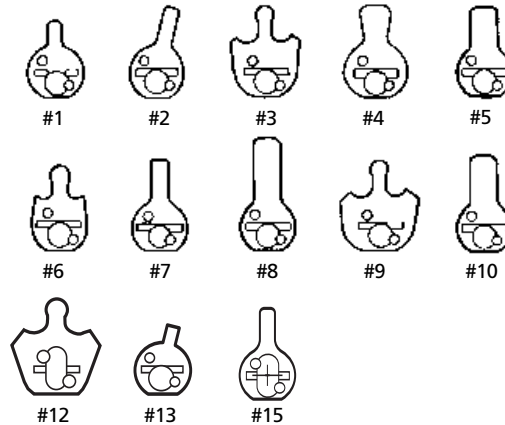

Tailpieces

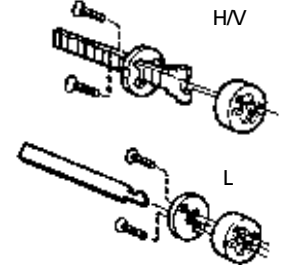

1-1/4" Mortise Cylinder

Mod/Cam#	Description	HD	HT	BL	BD	BH	BW	CBL	R	R-A	R-B	Comp	Sub	SNS	
Twin Pro															
6152IC-1	with Adams Rite Cam	1.366	0.175	1.125	1.157	1.055	0.655	1.247	0.036	0.118	0.555	120.50	113.00	106.00	
6152IC-2	with Sargent Cam	1.366	0.175	1.125	1.157	1.055	0.655	1.247	0.036	N/A	0.709	120.50	113.00	106.00	
6152IC-3	with Cor. Clover Leaf Cam	1.366	0.175	1.125	1.157	1.055	0.655	1.247	0.036	0.114	0.602	120.50	113.00	106.00	
6152IC-4	with Cor. Beaver Tail Cam	1.366	0.175	1.125	1.157	1.055	0.655	1.247	0.036	N/A	0.732	120.50	113.00	106.00	
6152IC-5	with Yale Standard Cam	1.366	0.175	1.125	1.157	1.055	0.655	1.247	0.036	N/A	0.709	120.50	113.00	106.00	
6152IC-6	with Schlage "L" Cam	1.366	0.175	1.125	1.157	1.055	0.655	1.247	0.036	0.124	0.516	120.50	113.00	106.00	
6152IC-7	with Segal Type Cam	1.366	0.175	1.125	1.157	1.055	0.655	1.247	0.036	N/A	0.779	120.50	113.00	106.00	
6152IC-8	with Corbin Jumbo Cam	1.366	0.175	1.125	1.157	1.055	0.655	1.247	0.036	N/A	0.914	120.50	113.00	106.00	
6152IC-9	with Best 30H Cam	1.366	0.175	1.125	1.157	1.055	0.655	1.247	0.036	0.114	0.602	120.50	113.00	106.00	
6152IC-10	with Norment/AirTeq Cam	1.366	0.175	1.125	1.157	1.055	0.655	1.247	0.036	N/A	0.787	120.50	113.00	106.00	
6152IC-12	w/ Cor. Jumbo Clover Leaf	1.366	0.175	1.125	1.157	1.055	0.655	1.247	0.036	0.114	0.828	120.50	113.00	106.00	
6152IC-13	with Sargent Short Cam	1.366	0.175	1.125	1.157	1.055	0.655	1.247	0.036	N/A	0.515	120.50	113.00	106.00	
6152IC-15	with Yale Rep. Cam	1.366	0.175	1.125	1.157	1.055	0.655	1.247	0.036	0.742	0.308	120.50	113.00	106.00	
Twin Maximum															
8852IC-1	with Adams Rite Cam	1.366	0.175	1.125	1.157	1.055	0.655	1.247	0.036	0.118	0.555	120.50	113.00	106.00	
8852IC-2	with Sargent Cam	1.366	0.175	1.125	1.157	1.055	0.655	1.247	0.036	N/A	0.709	120.50	113.00	106.00	
8852IC-3	with Cor. Clover Leaf Cam	1.366	0.175	1.125	1.157	1.055	0.655	1.247	0.036	0.114	0.602	120.50	113.00	106.00	
8852IC-4	with Cor. Beaver Tail Cam	1.366	0.175	1.125	1.157	1.055	0.655	1.247	0.036	N/A	0.732	120.50	113.00	106.00	
8852IC-5	with Yale Standard Cam	1.366	0.175	1.125	1.157	1.055	0.655	1.247	0.036	N/A	0.709	120.50	113.00	106.00	
8852IC-6	with Schlage "L" Cam	1.366	0.175	1.125	1.157	1.055	0.655	1.247	0.036	0.124	0.516	120.50	113.00	106.00	
8852IC-7	with Segal Type Cam	1.366	0.175	1.125	1.157	1.055	0.655	1.247	0.036	N/A	0.779	120.50	113.00	106.00	
8852IC-8	with Corbin Jumbo Cam	1.366	0.175	1.125	1.157	1.055	0.655	1.247	0.036	N/A	0.914	120.50	113.00	106.00	
8852IC-9	with Best 30H Cam	1.366	0.175	1.125	1.157	1.055	0.655	1.247	0.036	0.114	0.602	120.50	113.00	106.00	
8852IC-10	with Norment/AirTeq Cam	1.366	0.175	1.125	1.157	1.055	0.655	1.247	0.036	N/A	0.787	120.50	113.00	106.00	
8852IC-12	w/ Cor. Jumbo Clover Leaf	1.366	0.175	1.125	1.157	1.055	0.655	1.247	0.036	0.114	0.828	120.50	113.00	106.00	
8852IC-13	with Sargent Short Cam	1.366	0.175	1.125	1.157	1.055	0.655	1.247	0.036	N/A	0.515	120.50	113.00	106.00	
8852IC-15	with Yale Rep. Cam	1.366	0.175	1.125	1.157	1.055	0.655	1.247	0.036	0.742	0.308	120.50	113.00	106.00	
Twin Maximum Medium Security															
2852IC-1	with Adams Rite Cam	1.366	0.175	1.125	1.157	1.055	0.655	1.247	0.036	0.118	0.555	96.50	90.50	84.50	
2852IC-2	with Sargent Cam	1.366	0.175	1.125	1.157	1.055	0.655	1.247	0.036	N/A	0.709	96.50	90.50	84.50	
2852IC-3	with Cor. Clover Leaf Cam	1.366	0.175	1.125	1.157	1.055	0.655	1.247	0.036	0.114	0.602	96.50	90.50	84.50	
2852IC-4	with Cor. Beaver Tail Cam	1.366	0.175	1.125	1.157	1.055	0.655	1.247	0.036	N/A	0.732	96.50	90.50	84.50	
2852IC-5	with Yale Standard Cam	1.366	0.175	1.125	1.157	1.055	0.655	1.247	0.036	N/A	0.709	96.50	90.50	84.50	
2852IC-6	with Schlage "L" Cam	1.366	0.175	1.125	1.157	1.055	0.655	1.247	0.036	0.124	0.516	96.50	90.50	84.50	
2852IC-7	with Segal Type Cam	1.366	0.175	1.125	1.157	1.055	0.655	1.247	0.036	N/A	0.779	96.50	90.50	84.50	
2852IC-8	with Corbin Jumbo Cam	1.366	0.175	1.125	1.157	1.055	0.655	1.247	0.036	N/A	0.914	96.50	90.50	84.50	
2852IC-9	with Best 30H Cam	1.366	0.175	1.125	1.157	1.055	0.655	1.247	0.036	0.114	0.602	96.50	90.50	84.50	
2852IC-10	with Norment/AirTeq Cam	1.366	0.175	1.125	1.157	1.055	0.655	1.247	0.036	N/A	0.787	96.50	90.50	84.50	
2852IC-12	w/ Cor. Jumbo Clover Leaf	1.366	0.175	1.125	1.157	1.055	0.655	1.247	0.036	0.114	0.828	96.50	90.50	84.50	
2852IC-13	with Sargent Short Cam	1.366	0.175	1.125	1.157	1.055	0.655	1.247	0.036	N/A	0.515	96.50	90.50	84.50	
2852IC-15	with Yale Rep. Cam	1.366	0.175	1.125	1.157	1.055	0.655	1.247	0.036	0.742	0.308	96.50	90.50	84.50	

– Twin Maximum available with CLIQ™ Technology, add \$500.00. Example: 8852IC-1 x CLIQ x 626 x Sidebar x Comp. For temporary cores refer to Red Core on page 4.

TWIN V-10, TWIN EXCLUSIVE, TWIN PRO, TWIN MAXIMUM, CLIQ

Mortise and Rim IC Cylinders

Mortise Cylinder Key:

HD – Head Diameter • HT – Head Thickness
 BL – Body Length (Includes Cam) • BD – Body Diameter
 BH – Body Height • BW – Body Width • R – Retainer
 CBL – IC Core Body Length

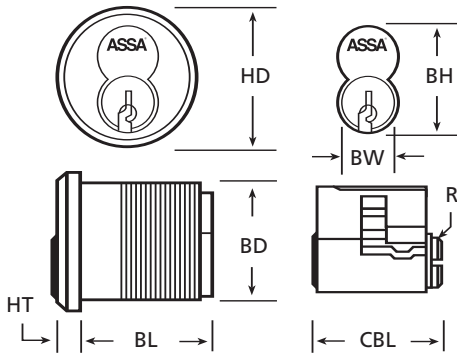

Available Cams

Cam Key:

R-A – Head Radius • R-B – Overall Radius

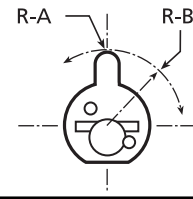
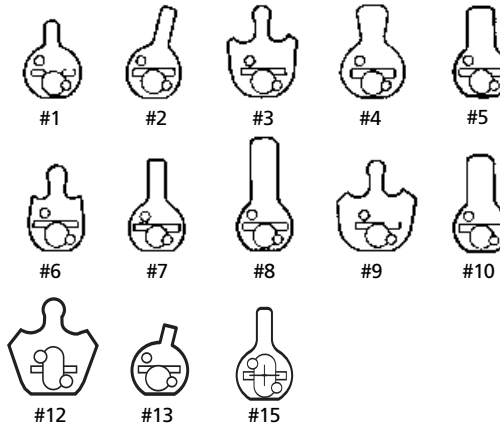

Tailpieces

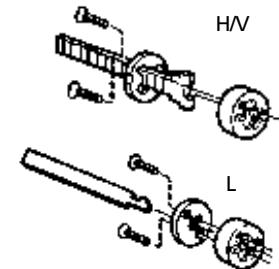

1-1/4" Mortise and Rim Cylinders











Mod/Cam#	Description	HD	HT	BL	BD	BH	BW	CBL	R	R-A	R-B	Comp	Sub	SNS
Twin V-10														
Rim Cylinders														
V6552IC-H	with Horizontal Tailpiece	1.366	0.175	1.125	1.157	1.055	0.665	1.247	0.036	N/A	N/A	128.00	120.50	113.50
V6552IC-V	with Vertical Tailpiece	1.366	0.175	1.125	1.157	1.055	0.665	1.247	0.036	N/A	N/A	128.00	120.50	113.50
V6552IC-L	with Lazy-Motion Tailpiece	1.366	0.175	1.125	1.157	1.055	0.665	1.247	0.036	N/A	N/A	128.00	120.50	113.50
Corbin Jumbo Rim Cylinders (Mortise & Rim)														
V7551IC-8	with Corbin Jumbo Cam	1.643	0.175	1.125	1.157	1.055	0.665	1.247	0.036	N/A	N/A	147.50	140.00	133.00
V7551IC-12	with Corbin Jumbo Clover Cam	1.643	0.175	1.125	1.157	1.055	0.665	1.247	0.036	N/A	N/A	147.50	140.00	133.00
V7551IC-H	with Horizontal Tailpiece	1.643	0.175	1.125	1.157	1.055	0.665	1.247	0.036	N/A	N/A	154.50	147.00	140.00
V7551IC-V	with Vertical Tailpiece	1.643	0.175	1.125	1.157	1.055	0.665	1.247	0.036	N/A	N/A	154.50	147.00	140.00
Interchangeable Core Cylinders Only														
V70600IC	ASSA IC Cylinder	N/A	N/A	N/A	N/A	1.055	0.665	1.247	0.036	N/A	N/A	75.00	69.50	62.50
V90600IC	Sargent IC Cylinder	N/A	N/A	N/A	N/A	N/A	N/A	1.247	0.036	N/A	N/A	75.00	69.50	62.50
V10600IC	Schlage IC Cylinder	N/A	N/A	N/A	N/A	1.045	0.628	1.450	0.036	N/A	N/A	75.00	69.50	62.50
V80600IC	Yale Style IC Cylinder	N/A	N/A	N/A	N/A	1.045	0.671	1.415	0.036	N/A	N/A	75.00	69.50	62.50
Twin Exclusive														
Rim Cylinders														
E6552IC-H	with Horizontal Tailpiece	1.366	0.175	1.125	1.157	1.055	0.665	1.247	0.036	N/A	N/A	128.00	120.50	113.50
E6552IC-V	with Vertical Tailpiece	1.366	0.175	1.125	1.157	1.055	0.665	1.247	0.036	N/A	N/A	128.00	120.50	113.50
E6552IC-L	with Lazy-Motion Tailpiece	1.366	0.175	1.125	1.157	1.055	0.665	1.247	0.036	N/A	N/A	128.00	120.50	113.50
Corbin Jumbo Rim Cylinders (Mortise & Rim)														
E7551IC-8	with Corbin Jumbo Cam	1.643	0.175	1.125	1.157	1.055	0.665	1.247	0.036	N/A	N/A	147.50	140.00	133.00
E7551IC-12	with Corbin Jumbo Clover Cam	1.643	0.175	1.125	1.157	1.055	0.665	1.247	0.036	N/A	N/A	147.50	140.00	133.00
E7551IC-H	with Horizontal Tailpiece	1.643	0.175	1.125	1.157	1.055	0.665	1.247	0.036	N/A	N/A	154.50	147.00	140.00
E7551IC-V	with Vertical Tailpiece	1.643	0.175	1.125	1.157	1.055	0.665	1.247	0.036	N/A	N/A	154.50	147.00	140.00
Interchangeable Core Cylinders Only														
E70600IC	ASSA IC Cylinder	N/A	N/A	N/A	N/A	1.055	0.665	1.247	0.036	N/A	N/A	75.00	69.50	62.50
E90600IC	Sargent IC Cylinder	N/A	N/A	N/A	N/A	N/A	N/A	1.247	0.036	N/A	N/A	75.00	69.50	62.50
E10600IC	Schlage IC Cylinder	N/A	N/A	N/A	N/A	1.045	0.628	1.450	0.036	N/A	N/A	75.00	69.50	62.50
E80600IC	Yale Style IC Cylinder	N/A	N/A	N/A	N/A	1.045	0.671	1.415	0.036	N/A	N/A	75.00	69.50	62.50
Twin 6000 Classic														
Rim Cylinders														
6552IC-H	with Horizontal Tailpiece	1.366	0.175	1.125	1.157	1.055	0.665	1.247	0.036	N/A	N/A	142.00	132.00	124.00
6552IC-V	with Vertical Tailpiece	1.366	0.175	1.125	1.157	1.055	0.665	1.247	0.036	N/A	N/A	142.00	132.00	124.00
6552IC-L	with Lazy-Motion Tailpiece	1.366	0.175	1.125	1.157	1.055	0.665	1.247	0.036	N/A	N/A	142.00	132.00	124.00
Corbin Jumbo Rim Cylinders (Mortise & Rim)														
7551IC-8	with Corbin Jumbo Cam	1.643	0.175	1.125	1.157	1.055	0.665	1.247	0.036	N/A	N/A	174.00	164.00	156.00
7551IC-12	with Corbin Jumbo Clover Cam	1.643	0.175	1.125	1.157	1.055	0.665	1.247	0.036	N/A	N/A	174.00	164.00	156.00
7551IC-H	with Horizontal Tailpiece	1.643	0.175	1.125	1.157	1.055	0.665	1.247	0.036	N/A	N/A	182.00	172.00	164.00
7551IC-V	with Vertical Tailpiece	1.643	0.175	1.125	1.157	1.055	0.665	1.247	0.036	N/A	N/A	182.00	172.00	164.00
Interchangeable Core Cylinders Only														
70600IC	ASSA IC Cylinder	N/A	N/A	N/A	N/A	1.055	0.665	1.247	0.036	N/A	N/A	91.00	82.00	73.00
80600IC	Yale Style IC Cylinder	N/A	N/A	N/A	N/A	1.045	0.671	1.415	0.036	N/A	N/A	91.00	82.00	73.00

For temporary cores refer to Red Core on page 4.

TWIN V-10, TWIN EXCLUSIVE, TWIN PRO, TWIN MAXIMUM, CLIQ

Mortise and Rim IC Cylinders

1-1/4" Mortise and Rim Cylinders

Mod/Cam#	Description	HD	HT	BL	BD	BH	BW	CBL	R	R-A	R-B	Comp	Sub	SNS
Twin Pro														
Rim Cylinders														
6152IC-H	with Horizontal Tailpiece	1.366	0.175	1.125	1.157	1.055	0.665	1.247	0.036	N/A	N/A	128.00	120.50	113.50
6152IC-V	with Vertical Tailpiece	1.366	0.175	1.125	1.157	1.055	0.665	1.247	0.036	N/A	N/A	128.00	120.50	113.50
6152IC-L	with Lazy-Motion Tailpiece	1.366	0.175	1.125	1.157	1.055	0.665	1.247	0.036	N/A	N/A	128.00	120.50	113.50
Corbin Jumbo Rim Cylinders (Mortise & Rim)														
7151IC-8	with Corbin Jumbo Cam	1.643	0.175	1.125	1.157	1.055	0.665	1.247	0.036	N/A	N/A	147.50	140.00	133.00
7151IC-12	with Corbin Jumbo Clover Cam	1.643	0.175	1.125	1.157	1.055	0.665	1.247	0.036	N/A	N/A	147.50	140.00	133.00
7151IC-H	with Horizontal Tailpiece	1.643	0.175	1.125	1.157	1.055	0.665	1.247	0.036	N/A	N/A	154.50	147.00	140.00
7151IC-V	with Vertical Tailpiece	1.643	0.175	1.125	1.157	1.055	0.665	1.247	0.036	N/A	N/A	154.50	147.00	140.00
Interchangeable Core Cylinders Only														
61600IC	ASSA IC Cylinder	N/A	N/A	N/A	N/A	1.055	0.665	1.247	0.036	N/A	N/A	75.00	69.50	62.50
69060IC	Sargent IC Cylinder	N/A	N/A	N/A	N/A	N/A	N/A	N/A	N/A	N/A	N/A	75.00	69.50	62.50
61060IC	Schlage IC Cylinder	N/A	N/A	N/A	N/A	1.045	0.628	1.450	0.036	N/A	N/A	75.00	69.50	62.50
68060IC	Yale Style IC Cylinder	N/A	N/A	N/A	N/A	1.045	0.628	1.450	0.036	N/A	N/A	75.00	69.50	62.50
Twin Maximum														
Rim Cylinders														
8852IC-H 	with Horizontal Tailpiece	1.366	0.175	1.125	1.157	1.055	0.665	1.247	0.036	N/A	N/A	128.00	120.50	113.50
8852IC-V 	with Vertical Tailpiece	1.366	0.175	1.125	1.157	1.055	0.665	1.247	0.036	N/A	N/A	128.00	120.50	113.50
8852IC-L 	with Lazy-Motion Tailpiece	1.366	0.175	1.125	1.157	1.055	0.665	1.247	0.036	N/A	N/A	128.00	120.50	113.50
Corbin Jumbo Rim Cylinders (Mortise & Rim)														
7851IC-8 	with Corbin Jumbo Cam	1.643	0.175	1.125	1.157	1.055	0.665	1.247	0.036	N/A	N/A	147.50	140.00	133.00
7851IC-12 	with Corbin Jumbo Clover Cam	1.643	0.175	1.125	1.157	1.055	0.665	1.247	0.036	N/A	N/A	147.50	140.00	133.00
7851IC-H 	with Horizontal Tailpiece	1.643	0.175	1.125	1.157	1.055	0.665	1.247	0.036	N/A	N/A	154.50	147.00	140.00
7851IC-V 	with Vertical Tailpiece	1.643	0.175	1.125	1.157	1.055	0.665	1.247	0.036	N/A	N/A	154.50	147.00	140.00
Interchangeable Core Cylinders Only														
88600IC 	ASSA IC Cylinder	N/A	N/A	N/A	N/A	1.055	0.665	1.247	0.036	N/A	N/A	75.00	69.50	62.50
89060IC 	Sargent IC Cylinder	N/A	N/A	N/A	N/A	N/A	N/A	1.247	0.036	N/A	N/A	75.00	69.50	62.50
81060IC 	Schlage IC Cylinder	N/A	N/A	N/A	N/A	1.045	0.628	1.450	0.036	N/A	N/A	75.00	69.50	62.50
88060IC 	Yale Style IC Cylinder	N/A	N/A	N/A	N/A	1.045	0.671	1.415	0.036	N/A	N/A	75.00	69.50	62.50
Twin Maximum Medium Security														
Interchangeable Core Cylinders Only														
28600IC	ASSA IC Cylinder	N/A	N/A	N/A	N/A	1.055	0.665	1.247	0.036	N/A	N/A	60.00	55.50	50.00
29060IC	Sargent IC Cylinder	N/A	N/A	N/A	N/A	N/A	N/A	1.247	0.036	N/A	N/A	60.00	55.50	50.00
21060IC	Schlage IC Cylinder	N/A	N/A	N/A	N/A	1.045	0.628	1.450	0.036	N/A	N/A	60.00	55.50	50.00
28060IC	Yale Style IC Cylinder	N/A	N/A	N/A	N/A	1.045	0.671	1.415	0.036	N/A	N/A	60.00	55.50	50.00
1-1/4" Temporary Interchangeable Construction Core Mortise/Rim Cylinder														
6552ICR*	1-1/4" Mortise IC Cylinder	1.366	0.175	1.125	1.157	—	—	—	—	—	—	120.50	—	—
6552ICR*	1-1/4" Rim IC Cylinder	1.366	0.175	1.125	1.157	—	—	—	—	—	—	127.50	—	—
Interchangeable Core Housings												Price		
60601*	IC Housing – Specify Cam												45.50	
60601*	IC Housing – Specify Tailpiece												52.50	
80601	1-1/2" Mogul IC Housing												129.50	

 – Twin Maximum available with CLIQ™ Technology, add \$500.00. Example: 88600IC x **CLIQ** x 626 x Sidebar x Comp

* – For temporary cores refer to Red Core on page 4.

TWIN V-10, TWIN EXCLUSIVE, TWIN PRO, TWIN MAXIMUM, CLIQ

Key-in-Knob/Lever Cylinders

ASSA Key in Knob/Key in Lever cylinders are designed to replace several original manufacturers' cylinders in their locksets offering the highest level of security available on the market today. These cylinders are manufactured to exact manufacturers' specifications to ensure precise fit and operation. ASSA Key in Knob/Key in Lever cylinders will improve the security of standard cylindrical locksets by Arrow, Corbin/Russwin, Falcon, Sargent, Schlage, Weiser, Yale and many other manufacturers. All ASSA Key in Knob/Key in Lever cylinders are listed under U.L. 437.



Benefits:

- Designed to exact manufacturers' specifications
- Two independent locking mechanisms to ensure security and optimum pick resistance
- Inactive "false" grooves on side pins designed to catch picking tools
- Extremely close tolerances
- Can be easily rekeyed in the field
- Patented key control

Warranty:

- ASSA guarantees its cylinders against defective workmanship or wear resulting from defects for life

Certification:

- All ASSA Key-in-Knob/Lever cylinders are U.L. 437 listed

Technical Information:

- Available in 16 different retrofit assemblies
- Cylinder shell and plug made of high quality brass
- Stainless steel top pins
- Bottom pins and master pins are nickel silver

Finishes:

<u>BHMA Symbol</u>	<u>U.S. Symbol</u>	<u>Euro Finishes</u>	<u>Description</u>
625	US 26	11	Bright Chrome
626	US 26D	13	Satin Chrome
605	US 3	20	Bright Brass
606	US 4	23	Satin Brass
612	US 10	33	Satin Bronze
624	US 10B	46	Dark Oxidized Bronze

TWIN V-10, TWIN EXCLUSIVE, TWIN PRO, TWIN MAXIMUM, CLIQ

Key-in-Knob/Lever Cylinders Ordering Information

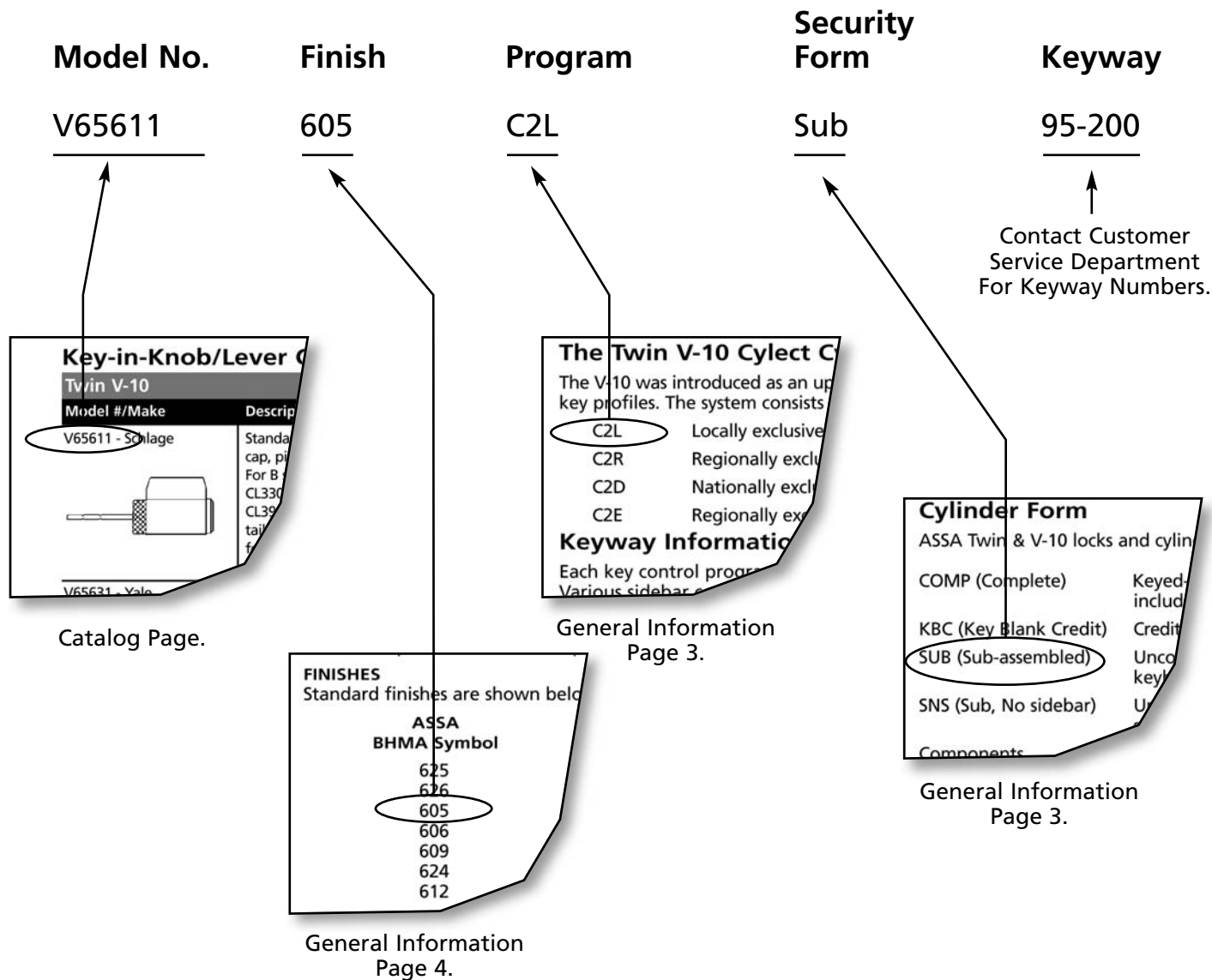

How To Order Twin V-10, Twin Exclusive Key-in-Knob/Lever Cylinders:

Specify	Model No.	Finish	Security Program	Form	Keyway
Example:	V65611	605	C2L	Sub	95-200

How To Order Twin Pro Key-in-Knob/Lever Cylinders:

Specify	Model No.	Finish	Form	Keyway
Example:	61611	605	Comp	0P4-200

TWIN V-10, TWIN EXCLUSIVE, TWIN PRO, TWIN MAXIMUM, CLIQ

Key-in-Knob/Levers Cylinders Exploded View

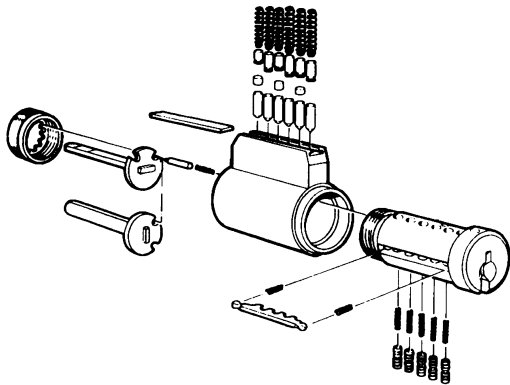
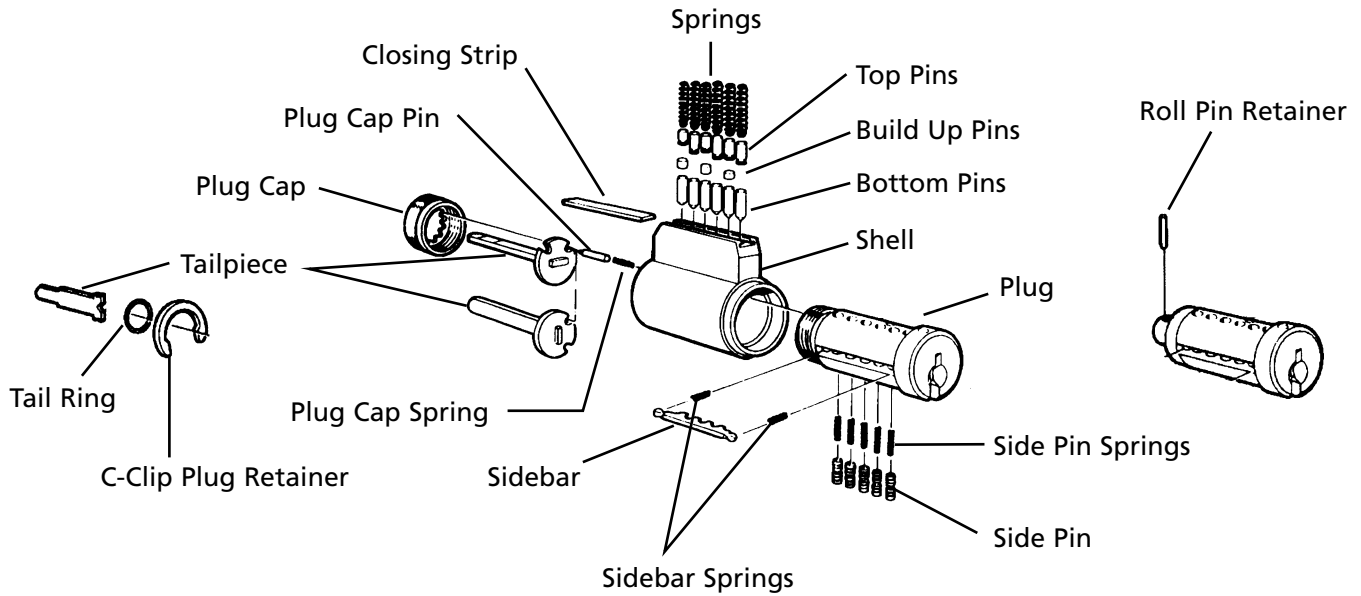

65611 – Schlage

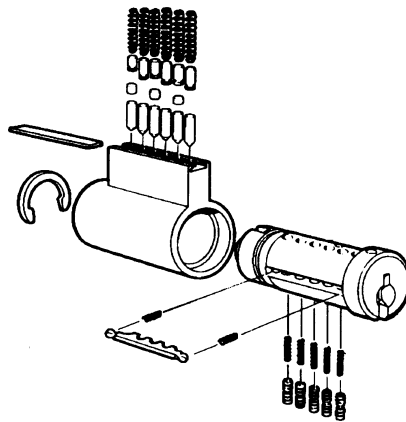

65631 – Yale

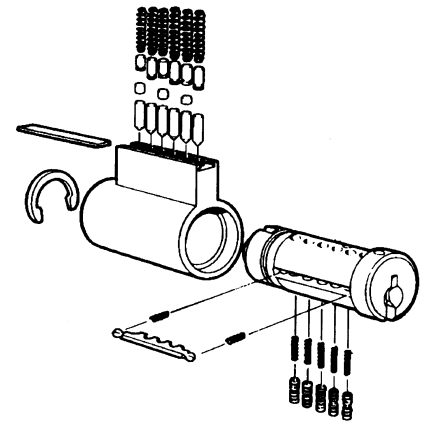

65632 – Yale

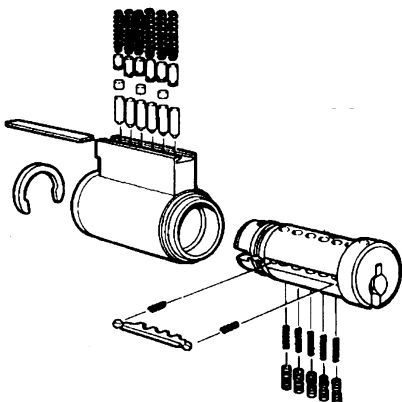

65651 – Corbin/Russwin

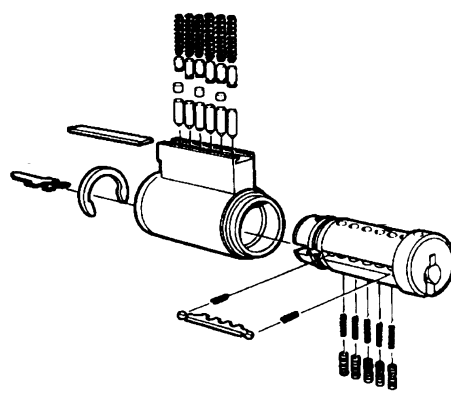

65652 – Corbin/Russwin

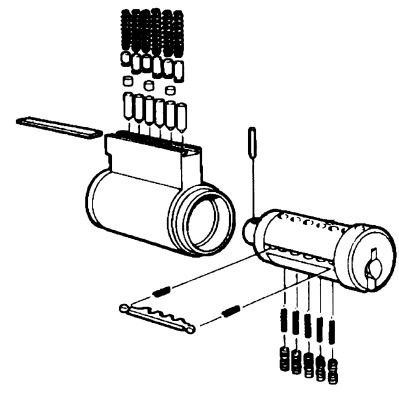

65653 – Corbin/Russwin

TWIN V-10, TWIN EXCLUSIVE, TWIN PRO, TWIN MAXIMUM, CLIQ

Key-in-Knob/Levers Cylinders Exploded View

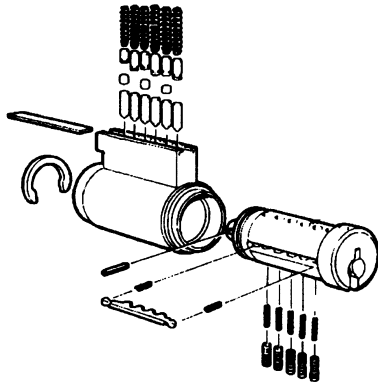

65654 – Corbin/Russwin

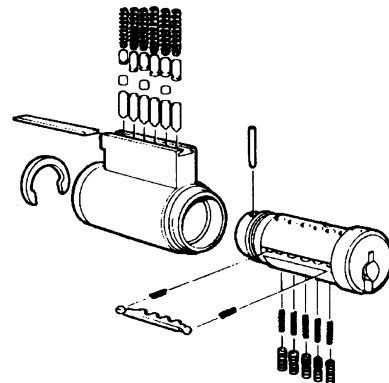

65655 – Corbin/Russwin

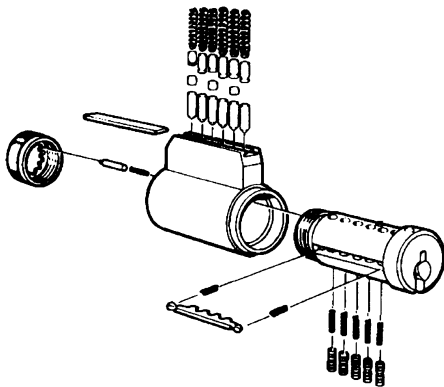

65661 – Falcon

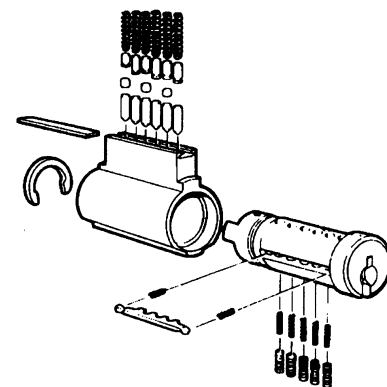

65671 – Sargent

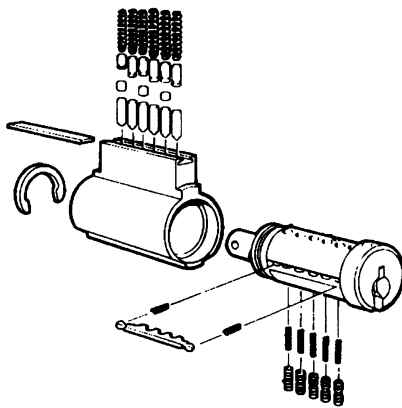

65672 – Sargent

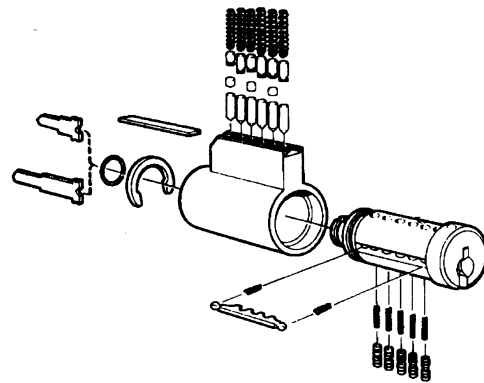

65673 – Sargent

TWIN V-10, TWIN EXCLUSIVE, TWIN PRO, TWIN MAXIMUM, CLIQ

Key-in-Knob/Levers Cylinders Exploded View

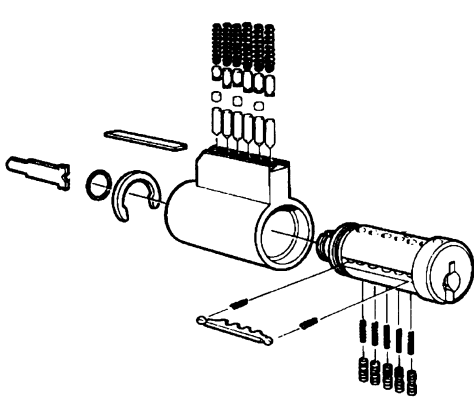

65673-TZ – Sargent

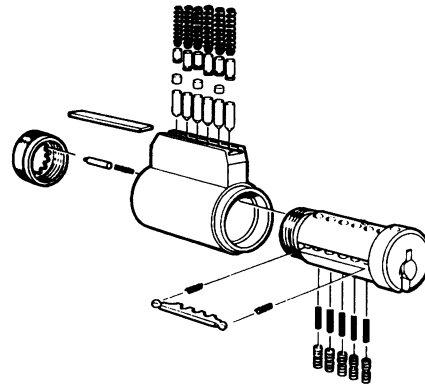

65681 – Weiser

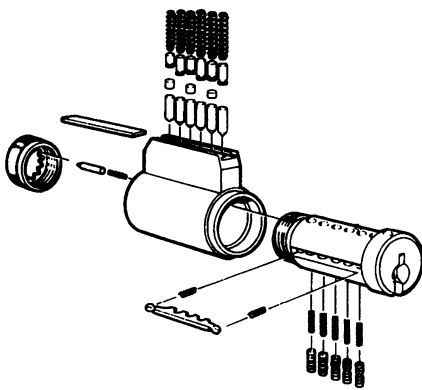

65682 – Weiser

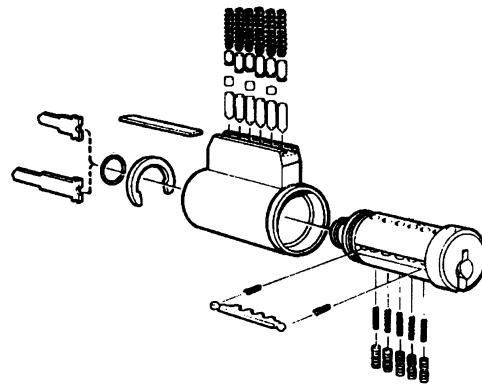

65691 – Arrow

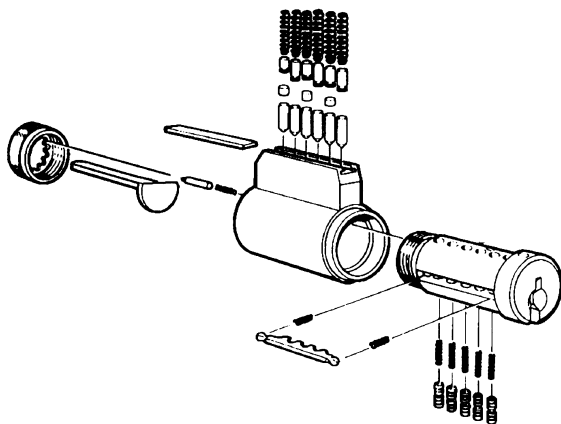

65692 – Arrow

TWIN V-10, TWIN EXCLUSIVE, TWIN PRO, TWIN MAXIMUM, CLIQ

Key-in-Knob/Lever Cylinders

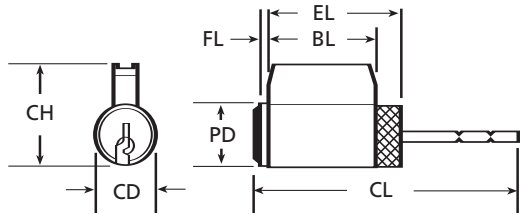

Key-in-Knob/Lever Key:

- BL** – Bible Length
- CD** – Cylinder Diameter
- CH** – Cylinder Height
- CL** – Cylinder Length
- EL** – Effective Length
- FL** – Front Length
- PD** – Plug Face Diameter

Key-in-Knob/Lever Cylinders

Twin V-10											
Model #/Make	Description	BL	CD	CH	CL	EL	FL	PD	Comp	Sub	SNS
V65611 - Schlage	Standard and heavy-duty 6-pin, includes cap, pin, spring and break-off tailpiece. For B series Deadbolts Corbin/Ruswin CL3300, CL3400, CL3600, CL3700, CK4700, CL3900 (Must use original manufacturer's tailpiece and stabilizing sleeve). CK4400 for all functions except 29, 55, & 82. Also use for A5 & N5 exit trim.	1.023	0.634	1.020	2.465	1.250	0.071	0.560	75.50	68.00	61.00
V65631 - Yale	Standard and heavy-duty	1.000	0.677	1.071	N/A	1.429	0.000	0.560	75.50	68.00	61.00
V65632 - Yale	Key-In-Lever style	1.000	0.677	1.071	2.975	1.429	0.000	0.560	75.50	68.00	61.00
V65651 - Corbin/Ruswin	Heavy-duty, new style (Not 3400, 3600, 3800 series) Use for CK4200, & UT5200	1.038	0.677	1.071	N/A	1.453	0.135	0.560	75.50	68.00	61.00
V65652 - Corbin/Ruswin	Standard-duty, new style tailpiece included. For CK4300, 5600, & B2, G2, G3 exit trim	1.038	0.677	1.071	2.165	1.453	0.135	0.560	75.50	68.00	61.00
V65653 - Corbin/Ruswin	Ruswin cylinder 19F35	1.0238	0.677	1.071	N/A	1.275	0.135	0.560	83.00	75.50	68.50
V65654 - Corbin/Ruswin	Ruswin cylinder 25F26, 25F56, 24F15, 67F69, 55F76	1.038	0.677	1.071	N/A	1.299	0.135	0.560	83.00	75.50	68.50
V65655 - Corbin/Ruswin	Ruswin cylinder 25F65	1.038	0.677	1.071	N/A	1.305	0.135	0.560	83.00	75.50	68.50

TWIN V-10, TWIN EXCLUSIVE, TWIN PRO, TWIN MAXIMUM, CLIQ



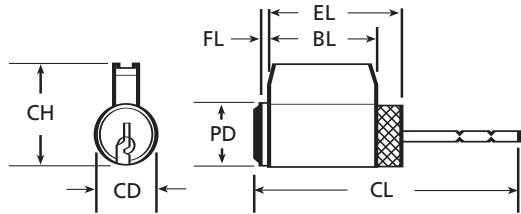

Key-in-Knob/Lever Cylinders

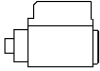
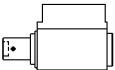

Key-in-Knob/Lever Key:

- BL** – Bible Length
- CD** – Cylinder Diameter
- CH** – Cylinder Height
- CL** – Cylinder Length
- EL** – Effective Length
- FL** – Front Length
- PD** – Plug Face Diameter

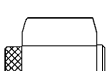
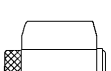
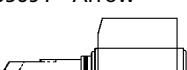
Key-in-Knob/Lever Cylinders

Twin V-10												
Model #/Make	Description	BL	CD	CH	CL	EL	FL	PD	Comp	Sub	SNS	
V65661 - Falcon 	S & X Series, Use original manufacturer cap and tailpiece	1.022	0.634	1.020	N/A	1.325	0.071	0.560	83.00	75.50	68.50	
V65671 - Sargent 	Integra	1.025	0.677	1.071	N/A	1.447	0.000	0.560	83.00	75.50	68.50	
V65672 - Sargent 	Heavy-duty 7, 8, 9 lines KIK	1.010	0.677	1.071	N/A	1.663	0.020	0.560	75.50	68.00	61.00	
V65673 - Sargent 	Standard duty 3 tailpieces included 6 Line KIK, 7 Line KIL, 10 Line KIL	0.990	0.634	1.020	2.000 2.040 2.315	1.235	0.000	0.560	75.50	68.00	61.00	
V65673-TZ - Sargent 	T-Zone 11 Line KIL	0.990	0.634	1.020	1.720	1.235	0.000	0.560	75.50	68.00	61.00	
V65681 - Weiser 	4000 & 9000 single cylinder deadbolts, entrance style handle locks	1.022	0.634	1.020	3.375	1.335	0.000	0.560	83.00	75.50	68.50	
V65682 - Weiser 	4000 & 9000 double cylinder dead- bolts, entrance style handle locks	1.022	0.634	1.020	1.910	1.335	0.000	0.560	83.00	75.50	68.50	
V65691 - Arrow 	Standard and heavy-duty, 3 tailpiece included for Arrow C, H, L, M, Q, S & W Series Key-in-Knob & Key-in-Lever styles	1.022	0.634	1.020	2.000 2.040 2.315	1.268	0.070	0.560	75.50	68.00	61.00	
V65692 - Arrow 	For Arrow deadbolts only, includes tailpieces for double & single cylinders	1.022	0.634	1.020	2.085 2.340 3.465	1.352	0.000	0.560	75.50	68.00	61.00	

TWIN V-10, TWIN EXCLUSIVE, TWIN PRO, TWIN MAXIMUM, CLIQ

Key-in-Knob/Lever Cylinders

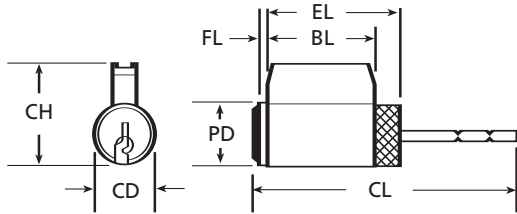

Key-in-Knob/Lever Key:

- BL** – Bible Length
- CD** – Cylinder Diameter
- CH** – Cylinder Height
- CL** – Cylinder Length

- EL** – Effective Length
- FL** – Front Length
- PD** – Plug Face Diameter

Key-in-Knob/Lever Cylinders

Twin Exclusive											
Model #/Make	Description	BL	CD	CH	CL	EL	FL	PD	Comp	Sub	SNS
E65611 - Schlage	Standard and heavy-duty 6-pin, includes cap, pin, spring and break-off tailpiece. For B series Deadbolts Corbin/Russwin CL3300, CL3400, CL3600, CL3700, CK4700, CL3900 (Must use original manufacturer's tailpiece and stabilizing sleeve). CK4400 for all functions except 29, 55, & 82. Also use for A5 & N5 exit trim.	1.023	0.634	1.020	2.465	1.250	0.071	0.560	75.50	68.00	61.00
E65631 - Yale	Standard and heavy-duty	1.000	0.677	1.071	N/A	1.429	0.000	0.560	75.50	68.00	61.00
E65632 - Yale	Key-In-Lever style	1.000	0.677	1.071	2.975	1.429	0.000	0.560	75.50	68.00	61.00
E65651 - Corbin/Russwin	Heavy-duty, new style (Not 3400, 3600, 3800 series) Use for CK4200, & UT5200	1.038	0.677	1.071	N/A	1.453	0.135	0.560	75.50	68.00	61.00
E65652 - Corbin/Russwin	Standard-duty, new style tailpiece included. For CK4300, 5600, & B2, G2, G3 exit trim	1.038	0.677	1.071	2.165	1.453	0.135	0.560	75.50	68.00	61.00
E65653 - Corbin/Russwin	Russwin cylinder 19F35	1.038	0.677	1.071	N/A	1.275	0.135	0.560	83.00	75.50	68.50
E65654 - Corbin/Russwin	Russwin cylinder 25F26, 25F56, 24F15, 67F69, 55F76	1.038	0.677	1.071	N/A	1.299	0.135	0.560	83.00	75.50	68.50
E65655 - Corbin/Russwin	Russwin cylinder 25F65	1.038	0.677	1.071	N/A	1.305	0.135	0.560	83.00	75.50	68.50

TWIN V-10, TWIN EXCLUSIVE, TWIN PRO, TWIN MAXIMUM, CLIQ



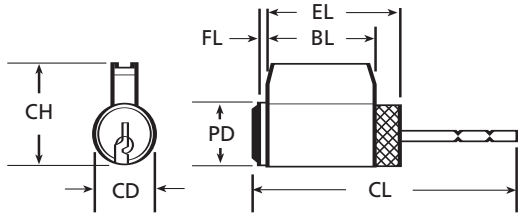

Key-in-Knob/Lever Cylinders

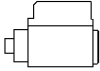
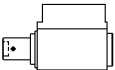

Key-in-Knob/Lever Key:

- BL** – Bible Length
- CD** – Cylinder Diameter
- CH** – Cylinder Height
- CL** – Cylinder Length
- EL** – Effective Length
- FL** – Front Length
- PD** – Plug Face Diameter

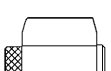
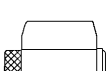
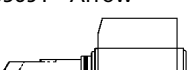
Key-in-Knob/Lever Cylinders

Twin Exclusive												
Model #/Make	Description	BL	CD	CH	CL	EL	FL	PD	Comp	Sub	SNS	
E65661 - Falcon 	S & X Series, Use original manufacturer cap and tailpiece	1.022	0.634	1.020	N/A	1.325	0.071	0.560	83.00	75.50	68.50	
E65671 - Sargent 	Integra	1.025	0.677	1.071	N/A	1.447	0.000	0.560	83.00	75.50	68.50	
E65672 - Sargent 	Heavy-duty 7, 8, 9 lines KIK	1.010	0.677	1.071	N/A	1.663	0.020	0.560	75.50	68.00	61.00	
E65673 - Sargent 	Standard duty 3 tailpieces included 6 Line KIK, 7 Line KIL, 10 Line KIL	0.990	0.634	1.020	2.000 2.040 2.315	1.235	0.000	0.560	75.50	68.00	61.00	
E65673-TZ - Sargent 	T-Zone 11 Line KIL	0.990	0.634	1.020	1.720	1.235	0.000	0.560	75.50	68.00	61.00	
E65681 - Weiser 	4000 & 9000 single cylinder deadbolts, entrance style handle locks	1.022	0.634	1.020	3.375	1.335	0.000	0.560	83.00	75.50	68.50	
E65682 - Weiser 	4000 & 9000 double cylinder deadbolts, entrance style handle locks	1.022	0.634	1.020	1.910	1.335	0.000	0.560	83.00	75.50	68.50	
E65691 - Arrow 	Standard and heavy-duty, 3 tailpiece included for Arrow C, H, L, M, Q, S & W Series key-in-knob & key-in-lever styles	1.022	0.634	1.020	2.000 2.040 2.315	1.268	0.070	0.560	75.50	68.00	61.00	
E65692 - Arrow 	For Arrow deadbolts only, includes 3 tailpieces for double & single cylinders	1.022	0.634	1.020	2.085 2.340 3.465	1.352	0.000	0.560	75.50	68.00	61.00	

TWIN V-10, TWIN EXCLUSIVE, TWIN PRO, TWIN MAXIMUM, CLIQ

Key-in-Knob/Lever Cylinders

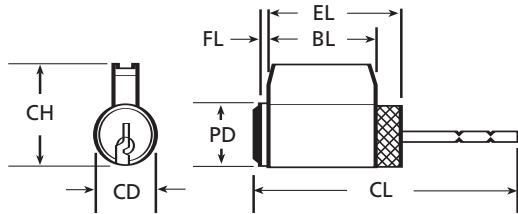

Key-in-Knob/Lever Key:

- BL** – Bible Length
- CD** – Cylinder Diameter
- CH** – Cylinder Height
- CL** – Cylinder Length
- EL** – Effective Length
- FL** – Front Length
- PD** – Plug Face Diameter

Key-in-Knob/Lever Cylinders

Twin 6000 Classic												
Model #/Make	Description	BL	CD	CH	CL	EL	FL	PD	Comp	Sub	SNS	
65611 - Schlage	Standard and heavy-duty 6-pin, includes cap, pin, spring and break-off tailpiece. For B series Deadbolts Corbin/Ruswin CL3300, CL3400, CL3600, CL3700, CK4700, CL3900 (Must use original manufacturer's tailpiece and stabilizing sleeve). CK4400 for all functions except 29, 55, & 82. Also use for A5 & N5 exit trim.	1.023	0.634	1.020	2.465	1.250	0.071	0.560	82.00	72.00	64.00	
65631 - Yale	Standard and heavy-duty	1.000	0.677	1.071	N/A	1.429	0.000	0.560	82.00	72.00	64.00	
65632 - Yale	Key-In-Lever style	1.000	0.677	1.071	2.975	1.429	0.000	0.560	82.00	72.00	64.00	
65651 - Corbin/Ruswin	Heavy-duty, new style (Not 3400, 3600, 3800 series) Use for CK4200, & UT5200	1.038	0.677	1.071	N/A	1.453	0.135	0.560	82.00	72.00	64.00	
65652 - Corbin/Ruswin	Standard-duty, new style tailpiece included. For CK4300, 5600, & B2, G2, G3 exit trim	1.038	0.677	1.071	2.165	1.453	0.135	0.560	82.00	72.00	64.00	
65653 - Corbin/Ruswin	Ruswin cylinder 19F35	1.038	0.677	1.071	N/A	1.275	0.135	0.560	83.00	73.00	65.00	
65654 - Corbin/Ruswin	Ruswin cylinder 25F26, 25F56, 24F15, 67F69, 55F76	1.038	0.677	1.071	N/A	1.299	0.135	0.560	83.00	73.00	65.00	
65655 - Corbin/Ruswin	Ruswin cylinder 25F65	1.038	0.677	1.071	N/A	1.305	0.135	0.560	83.00	73.00	65.00	

TWIN V-10, TWIN EXCLUSIVE, TWIN PRO, TWIN MAXIMUM, CLIQ

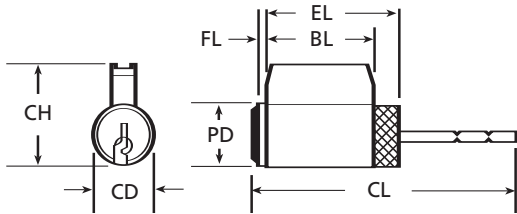

Key-in-Knob/Lever Cylinders



Key-in-Knob/Lever Key:

- BL** – Bible Length
- CD** – Cylinder Diameter
- CH** – Cylinder Height
- CL** – Cylinder Length
- EL** – Effective Length
- FL** – Front Length
- PD** – Plug Face Diameter

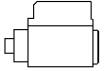
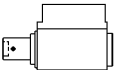
Key-in-Knob/Lever Cylinders

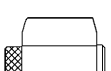
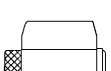
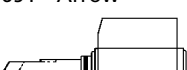
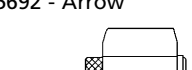
Twin 6000 Classic												
Model #/Make	Description	BL	CD	CH	CL	EL	FL	PD	Comp	Sub	SNS	
65661 - Falcon 	S & X Series, Use original manufacturer cap and tailpiece	1.022	0.634	1.020	N/A	1.325	0.071	0.560	83.00	73.00	65.00	
65671 - Sargent 	Integra	1.025	0.677	1.071	N/A	1.447	0.000	0.560	83.00	73.00	65.00	
65672 - Sargent 	Heavy-duty 7, 8, 9 lines KIK	1.010	0.677	1.071	N/A	1.663	0.020	0.560	82.00	72.00	64.00	
65673 - Sargent 	Standard duty 3 tailpieces included 6 Line KIK, 7 Line KIL, 10 Line KIL	0.990	0.634	1.020	2.000 2.040 2.315	1.235	0.000	0.560	82.00	72.00	64.00	
65673-TZ - Sargent 	T-Zone 11 Line KIL	0.990	0.634	1.020	1.720	1.235	0.000	0.560	82.00	72.00	64.00	
65681 - Weiser 	4000 & 9000 single cylinder deadbolts, entrance style handle locks	1.022	0.634	1.020	3.375	1.335	0.000	0.560	83.00	73.00	65.00	
65682 - Weiser 	4000 & 9000 double cylinder deadbolts, entrance style handle locks	1.022	0.634	1.020	1.910	1.335	0.000	0.560	83.00	73.00	65.00	
65691 - Arrow 	Standard and heavy-duty, 3 tailpiece included for Arrow C, H, L, M, Q, S & W Series key-in-knob & key-in-lever style	1.022	0.634	1.020	2.000 2.040 2.315	1.268	0.070	0.560	82.00	72.00	64.00	
65692 - Arrow 	For Arrow deadbolts only, includes 3 tailpieces for double & single cylinders	1.022	0.634	1.020	2.085 2.340 3.465	1.352	0.000	0.560	82.00	72.00	64.00	

TWIN V-10, TWIN EXCLUSIVE, TWIN PRO, TWIN MAXIMUM, CLIQ

Key-in-Knob/Lever Cylinders

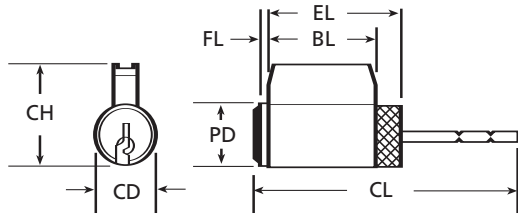

Key-in-Knob/Lever Key:

- BL** – Bible Length
- CD** – Cylinder Diameter
- CH** – Cylinder Height
- CL** – Cylinder Length
- EL** – Effective Length
- FL** – Front Length
- PD** – Plug Face Diameter

Key-in-Knob/Lever Cylinders

Twin Pro											
Model #/Make	Description	BL	CD	CH	CL	EL	FL	PD	Comp	Sub	SNS
61611 - Schlage	Standard and heavy-duty 6-pin, includes cap, pin, spring and break-off tailpiece. For B series Deadbolts Corbin/Ruswin CL3300, CL3400, CL3600, CL3700, CK4700, CL3900 (Must use original manufacturer's tailpiece and stabilizing sleeve). CK4400 for all functions except 29, 55, & 82. Also use for A5 & N5 exit trim.	1.023	0.634	1.020	2.465	1.250	0.071	0.560	75.50	68.00	61.00
61631 - Yale	Standard and heavy-duty	1.000	0.677	1.071	N/A	1.429	0.000	0.560	75.50	68.00	61.00
61632 - Yale	Key-In-Lever style	1.000	0.677	1.071	2.975	1.429	0.000	0.560	75.50	68.00	61.00
61651 - Corbin/Ruswin	Heavy-duty, new style (Not 3400, 3600, 3800 series) Use for CK4200, & UT5200	1.038	0.677	1.071	N/A	1.453	0.135	0.560	75.50	68.00	61.00
61652 - Corbin/Ruswin	Standard-duty, new style tailpiece included. For CK4300, 5600, & B2, G2, G3 exit trim	1.038	0.677	1.071	2.165	1.453	0.135	0.560	75.50	68.00	61.00
61653 - Corbin/Ruswin	Ruswin cylinder 19F35	1.038	0.677	1.071	N/A	1.275	0.135	0.560	83.00	75.50	68.50
61654 - Corbin/Ruswin	Ruswin cylinder 25F26, 25F56, 24F15, 67F69, 55F76	1.038	0.677	1.071	N/A	1.299	0.135	0.560	83.00	75.50	68.50
61655 - Corbin/Ruswin	Ruswin cylinder 25F65	1.038	0.677	1.071	N/A	1.305	0.135	0.560	83.00	75.50	68.50

TWIN V-10, TWIN EXCLUSIVE, TWIN PRO, TWIN MAXIMUM, CLIQ

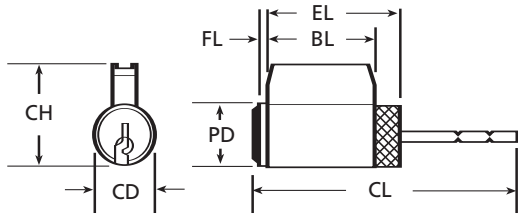

Key-in-Knob/Lever Cylinders



Key-in-Knob/Lever Key:

- BL** – Bible Length
- CD** – Cylinder Diameter
- CH** – Cylinder Height
- CL** – Cylinder Length
- EL** – Effective Length
- FL** – Front Length
- PD** – Plug Face Diameter

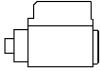
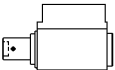
Key-in-Knob/Lever Cylinders

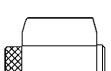
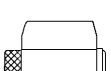
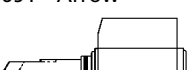
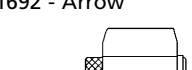
Twin Pro												
Model #/Make	Description	BL	CD	CH	CL	EL	FL	PD	Comp	Sub	SNS	
61661 - Falcon 	S & X Series, Use original manufacturer cap and tailpiece	1.022	0.634	1.020	N/A	1.325	0.071	0.560	83.00	75.50	68.50	
61671 - Sargent 	Integra	1.025	0.677	1.071	N/A	1.447	0.000	0.560	83.00	75.50	68.50	
61672 - Sargent 	Heavy-duty 7, 8, 9 lines KIK	1.010	0.677	1.071	N/A	1.663	0.020	0.560	75.50	68.00	61.00	
61673 - Sargent 	Standard duty 3 tailpieces included 6 Line KIK, 7 Line KIL, 10 Line KIL	0.990	0.634	1.020	2.000 2.040 2.315	1.235	0.000	0.560	75.50	68.00	61.00	
61673-TZ - Sargent 	T-Zone 11 Line KIL	0.990	0.634	1.020	1.720	1.235	0.000	0.560	75.50	68.00	61.00	
61681 - Weiser 	4000 & 9000 single cylinder deadbolts, entrance style handle locks	1.022	0.634	1.020	3.375	1.335	0.000	0.560	83.00	75.50	68.50	
61682 - Weiser 	4000 & 9000 double cylinder deadbolts, entrance style handle locks	1.022	0.634	1.020	1.910	1.335	0.000	0.560	83.00	75.50	68.50	
61691 - Arrow 	Standard and heavy-duty, 3 tailpiece included for Arrow C, H, L, M, Q, S & W Series key-in-knob & key-in-lever style	1.022	0.634	1.020	2.000 2.040 2.315	1.268	0.070	0.560	75.50	68.00	61.00	
61692 - Arrow 	For Arrow deadbolts only, includes 3 tailpieces for double & single cylinders	1.022	0.634	1.020	2.085 2.340 3.465	1.352	0.000	0.560	75.50	68.00	61.00	

TWIN V-10, TWIN EXCLUSIVE, TWIN PRO, TWIN MAXIMUM, CLIQ



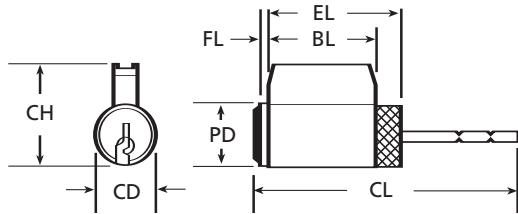





Key-in-Knob/Lever Cylinders



Key-in-Knob/Lever Key:

- BL** – Bible Length
- CD** – Cylinder Diameter
- CH** – Cylinder Height
- CL** – Cylinder Length
- EL** – Effective Length
- FL** – Front Length
- PD** – Plug Face Diameter

Key-in-Knob/Lever Cylinders

Twin Maximum												
Model #/Make	Description	BL	CD	CH	CL	EL	FL	PD	Comp	Sub	SNS	
88611 - Schlage 	Standard and heavy-duty 6-pin, includes cap, pin, spring and break-off tailpiece. For B series Deadbolts Corbin/Ruswin CL3300, CL3400, CL3600, CL3700, CK4700, CL3900 (Must use original manufacturer's tailpiece and stabilizing sleeve). CK4400 for all functions except 29, 55, & 82. Also use for A5 & N5 exit trim.	1.023	0.634	1.020	2.465	1.250	0.071	0.560	75.50	68.00	61.00	
88631 - Yale 	Standard and heavy-duty	1.000	0.677	1.071	N/A	1.429	0.000	0.560	75.50	68.00	61.00	
88632 - Yale 	Key-In-Lever style	1.000	0.677	1.071	2.975	1.429	0.000	0.560	75.50	68.00	61.00	
88651 - Corbin/Ruswin 	Heavy-duty, new style (Not 3400, 3600, 3800 series) Use for CK4200, & UT5200	1.038	0.677	1.071	N/A	1.453	0.135	0.560	75.50	68.00	61.00	
88652 - Corbin/Ruswin 	Standard-duty, new style tailpiece included. For CK4300, 5600, & B2, G2, G3 exit trim	1.038	0.677	1.071	2.165	1.453	0.135	0.560	75.50	68.00	61.00	
88653 - Corbin/Ruswin 	Ruswin cylinder 19F35	1.038	0.677	1.071	N/A	1.275	0.135	0.560	83.00	75.50	68.50	
88654 - Corbin/Ruswin 	Ruswin cylinder 25F26, 25F56, 24F15, 67F69, 55F76	1.038	0.677	1.071	N/A	1.299	0.135	0.560	83.00	75.50	68.50	
88655 - Corbin/Ruswin 	Ruswin cylinder 25F65	1.038	0.677	1.071	N/A	1.305	0.135	0.560	83.00	75.50	68.50	

 – Twin Maximum available with CLIQ™ Technology, add \$500.00. Example: 88611 x **CLIQ** x 626 x Sidebar x Comp

TWIN V-10, TWIN EXCLUSIVE, TWIN PRO, TWIN MAXIMUM, CLIQ

Key-in-Knob/Lever Cylinders

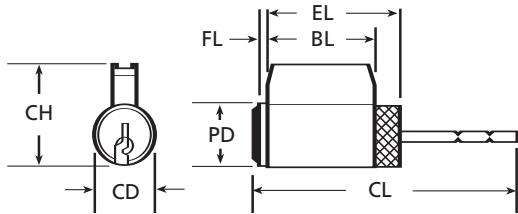

Key-in-Knob/Lever Key:

- BL** – Bible Length
- CD** – Cylinder Diameter
- CH** – Cylinder Height
- CL** – Cylinder Length
- EL** – Effective Length
- FL** – Front Length
- PD** – Plug Face Diameter

Key-in-Knob/Lever Cylinders

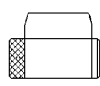
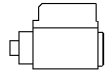
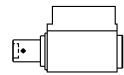
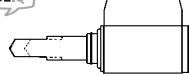
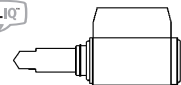
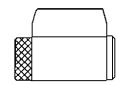
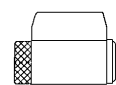
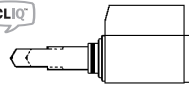
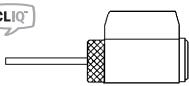
Twin Maximum												
Model #/Make	Description	BL	CD	CH	CL	EL	FL	PD	Comp	Sub	SNS	
88661 - Falcon 	S & X Series, Use original manufacturer cap and tailpiece	1.022	0.634	1.020	N/A	1.325	0.071	0.560	83.00	75.50	68.50	
88671 - Sargent 	Integra	1.025	0.677	1.071	N/A	1.447	0.000	0.560	83.00	75.50	68.50	
88672 - Sargent 	Heavy-duty 7, 8, 9 lines KIK	1.010	0.677	1.071	N/A	1.663	0.020	0.560	75.50	68.00	61.00	
88673 - Sargent 	Standard duty 3 tailpieces included 6 Line KIK, 7 Line KIL, 10 Line KIL	0.990	0.634	1.020	2.000 2.040 2.315	1.235	0.000	0.560	75.50	68.00	61.00	
88673-TZ - Sargent 	T-Zone 11 Line KIL	0.990	0.634	1.020	1.720	1.235	0.000	0.560	75.50	68.00	61.00	
88681 - Weiser 	4000 & 9000 single cylinder deadbolts, entrance style handle locks	1.022	0.634	1.020	3.375	1.335	0.000	0.560	83.00	75.50	68.50	
88682 - Weiser 	4000 & 9000 double cylinder deadbolts, entrance style handle locks	1.022	0.634	1.020	1.910	1.335	0.000	0.560	83.00	75.50	68.50	
88691 - Arrow 	Standard and heavy-duty, 3 tailpiece included for Arrow C, H, L, M, Q, S & W Series key-in-knob & key-in-lever style	1.022	0.634	1.020	2.000 2.040 2.315	1.268	0.070	0.560	75.50	68.00	61.00	
88692 - Arrow 	For Arrow deadbolts only, includes 3 tailpieces for double & single cylinders	1.022	0.634	1.020	2.085 2.340 3.465	1.352	0.000	0.560	75.50	68.00	61.00	

 – Twin Maximum available with CLIQ™ Technology, add \$500.00. Example: 88673 x **CLIQ** x 626 x Sidebar x Comp

TWIN V-10, TWIN EXCLUSIVE, TWIN PRO, TWIN MAXIMUM, CLIQ

Key-in-Knob/Lever Cylinders

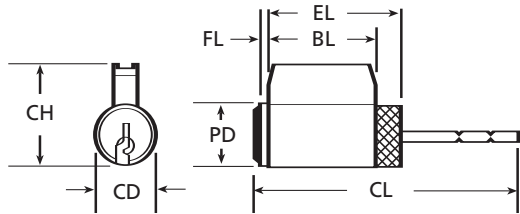

Key-in-Knob/Lever Key:

- BL** – Bible Length
- CD** – Cylinder Diameter
- CH** – Cylinder Height
- CL** – Cylinder Length
- EL** – Effective Length
- FL** – Front Length
- PD** – Plug Face Diameter

Key-in-Knob/Lever Cylinders

Twin Maximum Medium Security											
Model #/Make	Description	BL	CD	CH	CL	EL	FL	PD	Comp	Sub	SNS
28611 - Schlage	Standard and heavy-duty 6-pin, includes cap, pin, spring and break-off tailpiece. For B series Deadbolts Corbin/Ruswin CL3300, CL3400, CL3600, CL3700, CK4700, CL3900 (Must use original manufacturer's tailpiece and stabilizing sleeve). CK4400 for all functions except 29, 55, & 82. Also use for A5 & N5 exit trim.	1.023	0.634	1.020	2.465	1.250	0.071	0.560	62.50	56.50	51.00
28631 - Yale	Standard and heavy-duty	1.000	0.677	1.071	N/A	1.429	0.000	0.560	62.50	56.50	51.00
28632 - Yale	Key-In-Lever style	1.000	0.677	1.071	2.975	1.429	0.000	0.560	62.50	56.50	51.00
28651 - Corbin/Ruswin	Heavy-duty, new style (Not 3400, 3600, 3800 series) Use for CK4200, & UT5200	1.038	0.677	1.071	N/A	1.453	0.135	0.560	62.50	56.50	51.00
28652 - Corbin/Ruswin	Standard-duty, new style tailpiece included. For CK4300, 5600, & B2, G2, G3 exit trim	1.038	0.677	1.071	2.165	1.453	0.135	0.560	62.50	56.50	51.00
28672 - Sargent	Heavy-duty 7, 8, 9 lines KIK	1.010	0.677	1.071	N/A	1.663	0.020	0.560	62.50	56.50	51.00
28673 - Sargent	Standard duty 3 tailpieces included 6 Line KIK, 7 Line KIL, 10 Line KIL	0.990	0.634	1.020	2.000 2.040 2.315	1.235	0.000	0.560	62.50	56.50	51.00
28673-TZ - Sargent	T-Zone 11 Line KIL	0.990	0.634	1.020	1.720	1.235	0.000	0.560	62.50	56.50	51.00
28691 - Arrow	Standard and heavy-duty, 3 tailpiece included for Arrow C, H, L, M, Q, S & W Series key-in-knob & key-in-lever style	1.022	0.634	1.020	2.000 2.040 2.315	1.268	0.070	0.560	62.50	56.50	51.00

TWIN V-10, TWIN EXCLUSIVE, TWIN PRO, TWIN MAXIMUM, CLIQ

Key-in-Knob/Lever Cylinders

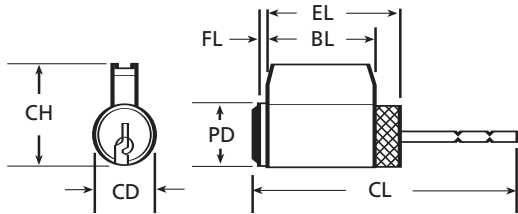

Key-in-Knob/Lever Key:

- BL** – Bible Length
- CD** – Cylinder Diameter
- CH** – Cylinder Height
- CL** – Cylinder Length
- EL** – Effective Length
- FL** – Front Length
- PD** – Plug Face Diameter

Key-in-Knob/Lever Cylinders

Twin Low & Twin 600 Series Classic			BL	CD	CH	CL	EL	FL	PD	Comp	Sub	SNS
L6611	6611 Schlage	Standard and heavy-duty 6-pin, includes cap, pin, spring and break-off tailpiece. For B series Deadbolts Corbin/Russwin CL3300, CL3400, CL3600, CL3700, CK4700, CL3900 (Must use original manufacturer's tailpiece and stabilizing sleeve). CK4400 for all functions except 29, 55, & 82. Also use for A5 & N5 exit trim.	1.023	0.634	1.020	2.465	1.250	0.071	0.560	66.00	57.00	—
L6631	6631 Yale	Standard and heavy-duty	1.000	0.677	1.071	N/A	1.429	0.000	0.560	66.00	57.00	—
L6632	6632 Yale	Key-In-Lever style	1.000	0.677	1.071	2.975	1.429	0.000	0.560	66.00	57.00	—
L6651	6651 Corbin/ Russwin	Heavy-duty, new style (Not 3400, 3600, 3800 series) Use for CK4200, & UT5200	1.038	0.677	1.071	N/A	1.453	0.135	0.560	66.00	57.00	—
L6652	6652 Corbin/ Russwin	Standard-duty, new style tailpiece included. For CK4300, 5600, & B2, G2, G3 exit trim	1.038	0.677	1.071	2.165	1.453	0.135	0.560	66.00	57.00	—
L6653	6653 Corbin/ Russwin	Russwin cylinder 19F35	1.038	0.677	1.071	N/A	1.275	0.135	0.560	66.00	57.00	—
L6654	6654 Corbin/ Russwin	Russwin cylinder 25F26, 25F56, 24F15, 67F69, 55F76	1.038	0.677	1.071	N/A	1.299	0.135	0.560	66.00	57.00	—
L6655	6655 Corbin/ Russwin	Russwin cylinder 25F65	1.038	0.677	1.071	N/A	1.305	0.135	0.560	66.00	57.00	—

TWIN V-10, TWIN EXCLUSIVE, TWIN PRO, TWIN MAXIMUM, CLIQ

Key-in-Knob/Lever Cylinders

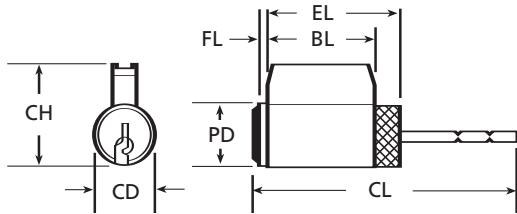



Key-in-Knob/Lever Key:

- BL** – Bible Length
- CD** – Cylinder Diameter
- CH** – Cylinder Height
- CL** – Cylinder Length

- EL** – Effective Length
- FL** – Front Length
- PD** – Plug Face Diameter

Key-in-Knob/Lever Cylinders

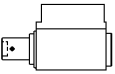
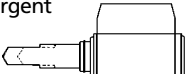
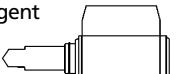
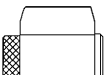
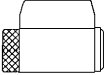
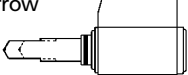
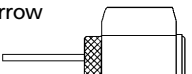
Twin Maximum												
Model #/Make	Description	BL	CD	CH	CL	EL	FL	PD	Comp	Sub	SNS	
L6661 6661 Falcon 	S & X Series, Use original manufacturer cap and tailpiece	1.022	0.634	1.020	N/A	1.325	0.071	0.560	66.00	57.00	—	
L6671 6671 Sargent 	Integra	1.025	0.677	1.071	N/A	1.447	0.000	0.560	66.00	57.00	—	
L6672 6672 Sargent 	Heavy-duty 7, 8, 9 lines KIK	1.010	0.677	1.071	N/A	1.663	0.020	0.560	66.00	57.00	—	
L6673 6673 Sargent 	Standard duty 3 tailpieces included 6 Line KIK, 7 Line KIL, 10 Line KIL	0.990	0.634	1.020	2.000 2.040 2.315	1.235	0.000	0.560	66.00	57.00	—	
L6673-TZ 6673-TZ Sargent 	T-Zone 11 Line KIL	0.990	0.634	1.020	1.720	1.235	0.000	0.560	66.00	57.00	—	
L6681 6681 Weiser 	4000 & 9000 single cylinder deadbolts, entrance style handle locks	1.022	0.634	1.020	3.375	1.335	0.000	0.560	66.00	57.00	—	
L6682 6682 Weiser 	4000 & 9000 double cylinder dead- bolts, entrance style handle locks	1.022	0.634	1.020	1.910	1.335	0.000	0.560	66.00	57.00	—	
L6691 6691 Arrow 	Standard and heavy-duty, 3 tailpiece included for Arrow C, H, L, M, Q, S & W Series key-in-knob & key-in-lever style	1.022	0.634	1.020	2.000 2.040 2.315	1.268	0.070	0.560	66.00	57.00	—	
L6692 6692 Arrow 	For Arrow deadbolts only, includes 3 tailpieces for double & single cylinders	1.022	0.634	1.020	2.085 2.340 3.465	1.352	0.000	0.560	66.00	57.00	—	

TWIN V-10, TWIN EXCLUSIVE, TWIN PRO, TWIN MAXIMUM, CLIQ

Key-in-Knob/Lever Component Parts

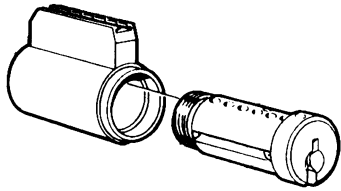

Schlage – 61611

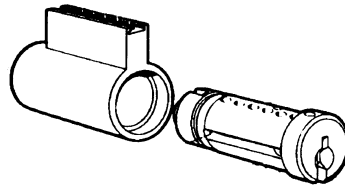

Yale – 61631

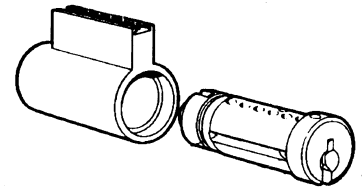

Yale – 61632

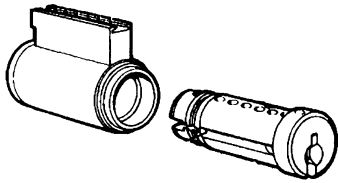

Corbin/Russwin – 61651

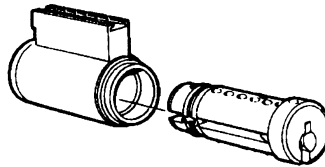

Corbin/Russwin – 61652

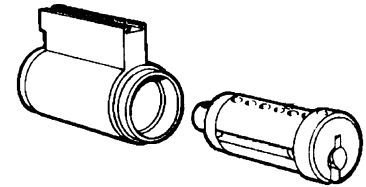

Corbin/Russwin – 61653

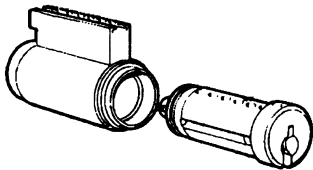

Corbin/Russwin – 61654

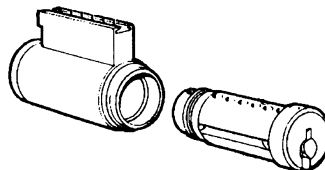

Corbin/Russwin – 61655

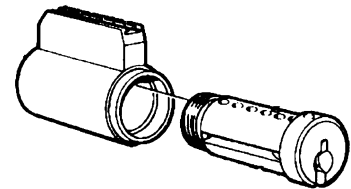

Falcon – 61661

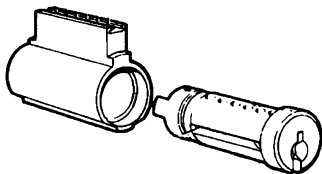

Sargent – 61671

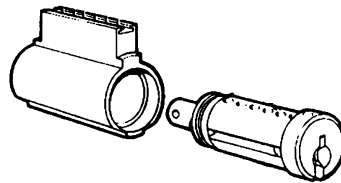

Sargent – 61672

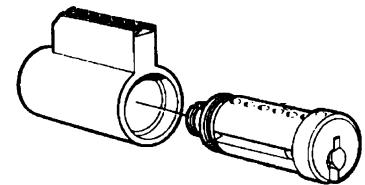

Sargent – 61673

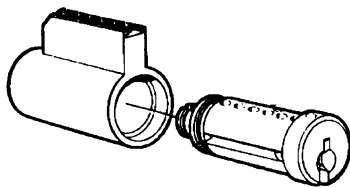

Sargent – 61673-TZ

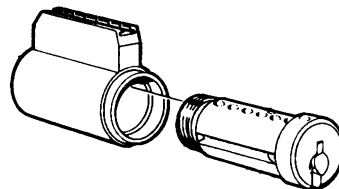

Weiser – 61681

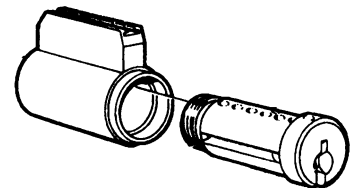

Weiser – 61682

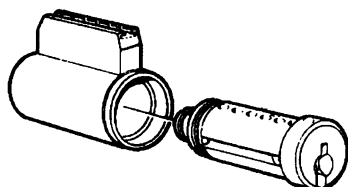

Arrow – 61691

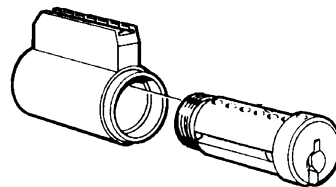

Arrow – 61692

TWIN V-10, TWIN EXCLUSIVE, TWIN PRO, TWIN MAXIMUM, CLIQ

Key-in-Knob/Lever Component Parts

Key-in-Knob/Lever Parts

Model No.	Description	Price
Twin V-10		
868056	Schlage Cylinder Shell	30.00
868057	Yale Cylinder Shell	30.00
367156	Russwin/Corbin Cylinder Shell	30.00
868060	Sargent Integra Cylinder Shell	30.00
868061	Sargent Heavy-duty Cylinder Shell	30.00
367159	Sargent Standard-duty Cylinder Shell	30.00
250619	Arrow Cylinder Shell	30.00
907203	Arrow Deadbolt/Weiser KIK Shell	30.00
353978	Schlage Cylinder Plug*	31.00
353979	Yale Cylinder Plug* – (Must specify KIK or KIL).	23.50
353980	Sargent Integra Cylinder Plug*	32.00
353981	Sargent Heavy-Duty 7, 8, 9 Cylinder Plug*	30.00
353982	Falcon S & X Series/Weiser Deadbolt Plug	32.00
353983	Arrow/Sargent 6-line Cylinder Plug*	23.50
353984	Russwin/Corbin std. & Heavy-Duty Cylinder Plug*	25.50
353985	Russwin/Corbin 19F35 Cylinder Plug*	25.50
353986	Corbin 25F26 Cylinder Plug*	25.50
353787	Russwin/Corbin 25F65 Cylinder Plug*	25.50
453978	Arrow Deadbolt Plug*	23.50
92C-114	Arrow Deadbolt Cap	2.25/ea.
92C-127	Arrow Deadbolt Plug Cap Spring	.50/ea.
92C-128	Arrow Deadbolt Plug Cap Pin	.25/ea.
92C-121	Arrow Deadbolt Washer	.35/ea.
92C-123	Arrow Deadbolt Blocking Piece	1.50/ea.
D61-44	Arrow Deadbolt Long Tailpiece (Single Cylinder)	2.10/ea.
D62-44	Arrow Deadbolt Short Tailpiece (Double Cylinder)	1.50/ea.
Twin Exclusive		
868056	Schlage Cylinder Shell	30.00
868057	Yale Cylinder Shell	30.00
367156	Russwin/Corbin Cylinder Shell	30.00
868060	Sargent Integra Cylinder Shell	30.00
868061	Sargent Heavy-duty Cylinder Shell	30.00
367159	Sargent Standard-duty Cylinder Shell	30.00
250619	Arrow Cylinder Shell	30.00
907203	Arrow Deadbolt/Weiser KIK Shell	30.00
367068	Schlage Cylinder Plug*	30.00
367069	Yale Cylinder Plug* – (Must specify KIK or KIL).	30.00
367073	Sargent Integra Cylinder Plug*	32.00
367074	Sargent Heavy-Duty 7, 8, 9 Cylinder Plug*	30.00
868233	Falcon S & X Series/Weiser Deadbolt Plug	32.00
868607	Arrow/Sargent 6-line Cylinder Plug*	23.50
868649	Russwin/Corbin std. & Heavy-Duty Cylinder Plug*	25.50
868650	Russwin/Corbin 19F35 Cylinder Plug*	25.50
868651	Corbin 25F26 Cylinder Plug*	25.50
868652	Russwin/Corbin 25F65 Cylinder Plug*	25.50
467068	Arrow Deadbolt Plug*	23.50
92C-114	Arrow Deadbolt Cap	2.25/ea.
92C-127	Arrow Deadbolt Plug Cap Spring	.50/ea.
92C-128	Arrow Deadbolt Plug Cap Pin	.25/ea.
92C-121	Arrow Deadbolt Washer	.35/ea.
92C-123	Arrow Deadbolt Blocking Piece	1.50/ea.
D61-44	Arrow Deadbolt Long Tailpiece (Single Cylinder)	2.10/ea.
D62-44	Arrow Deadbolt Short Tailpiece (Double Cylinder)	1.50/ea.

* - Indicates Finished Components

TWIN V-10, TWIN EXCLUSIVE, TWIN PRO, TWIN MAXIMUM, CLIQ

Key-in-Knob/Lever Component Parts

Key-in-Knob/Lever Parts

Model No.	Description	Price
Twin Pro		
868056	Schlage Cylinder Shell	30.00
868057	Yale Cylinder Shell	30.00
367156	Russwin/Corbin Cylinder Shell	30.00
868060	Sargent Integra Cylinder Shell	30.00
868061	Sargent Heavy-duty Cylinder Shell	30.00
367159	Sargent Standard-duty Cylinder Shell	30.00
250619	Arrow Cylinder Shell	30.00
907203	Arrow Deadbolt/Weiser KIK Shell	30.00
356982	Schlage Cylinder Plug*†	30.00
356983	Yale Cylinder Plug* – (Must specify KIK or KIL)†	30.00
356988	Sargent Integra Cylinder Plug*†	32.00
356989	Sargent Heavy-Duty 7, 8, 9 Cylinder Plug*†	30.00
356990	Arrow/Sargent 6-line Cylinder Plug*†	30.00
356984	Russwin/Corbin std. & Heavy-Duty Cylinder Plug*†	32.00
356985	Russwin/Corbin 19F35 Cylinder Plug*†	32.00
356986	Corbin 25F26 Cylinder Plug*†	32.00
356987	Russwin/Corbin 25F65 Cylinder Plug*†	32.00
92C-114	Arrow Deadbolt Cap	2.25/ea.
92C-127	Arrow Deadbolt Plug Cap Spring	.50/ea.
92C-128	Arrow Deadbolt Plug Cap Pin	.25/ea.
92C-121	Arrow Deadbolt Washer	.35/ea.
92C-123	Arrow Deadbolt Blocking Piece	1.50/ea.
D61-44	Arrow Deadbolt Long Tailpiece (Single Cylinder)	2.10/ea.
D62-44	Arrow Deadbolt Short Tailpiece (Double Cylinder)	1.50/ea.

* – Indicates Finished Components.

† – Specify Profile 0P4 for Twin Pro or 0M7 for Twin Maximum.

TWIN V-10, TWIN EXCLUSIVE, TWIN PRO, TWIN MAXIMUM, CLIQ

Deadbolts

The ASSA 6000 Series deadbolt is designed to withstand any form of physical attack including drilling, prying, driving, or pulling. Its free spinning guard collars protect it from pipe wrenching while its hardened inserts guard against drilling. The 6000 comes equipped with the ASSA Hardhat™ to protect it from outside through-the-door attacks known as "ice picking." All ASSA 6000 Series deadbolts are available with interchangeable core and feature our unique dual locking mechanism rendering them virtually pick proof. As with all ASSA high security cylinders, our patented key control ensures the ultimate protection against unauthorized key duplication.

**Benefits:**

- ASSA Hardhat™ to prevent physical attack
- Free spinning guard collars to prevent wrenching
- Available in interchangeable core
- High security solid brass cylinders
- 1/4" Aircraft strength steel mounting bolts
- Hardened bolt with full 1" throw
- Non-handed
- Patented key control

Warranty:

- ASSA guarantees its products against defective workmanship or wear resulting from defects for life Certification

Certification:

- All ASSA 6000 Deadbolts are U.L. 437 Listed as well as ASTM F 1577 6.6 Certified for standard test methods for Detention Locks

Technical Information:

- Available in single and double cylinder and no thumb turn inside models
- Available in 2-3/8" and 2-3/4" backsets drive-in or face plate
- Available 1-3/8" to 2-1/2" door thickness, 1-3/4" standard
- Cylinder housing and plug made of high quality brass
- Stainless steel top pins
- Bottom pins and master pins are nickel silver

Finishes:

BHMA Symbol	U.S. Symbol	Euro Finishes	Description
625	US 26	11	Bright Chrome
626	US 26D	13	Satin Chrome
605	US 3	20	Bright Brass
606	US 4	23	Satin Brass
609	US 5	47	Antique Brass
612	US 10	33	Satin Bronze
624	US 10B	46	Dark Oxidized Bronze

TWIN V-10, TWIN EXCLUSIVE, TWIN PRO, TWIN MAXIMUM, CLIQ

Deadbolts Ordering Information

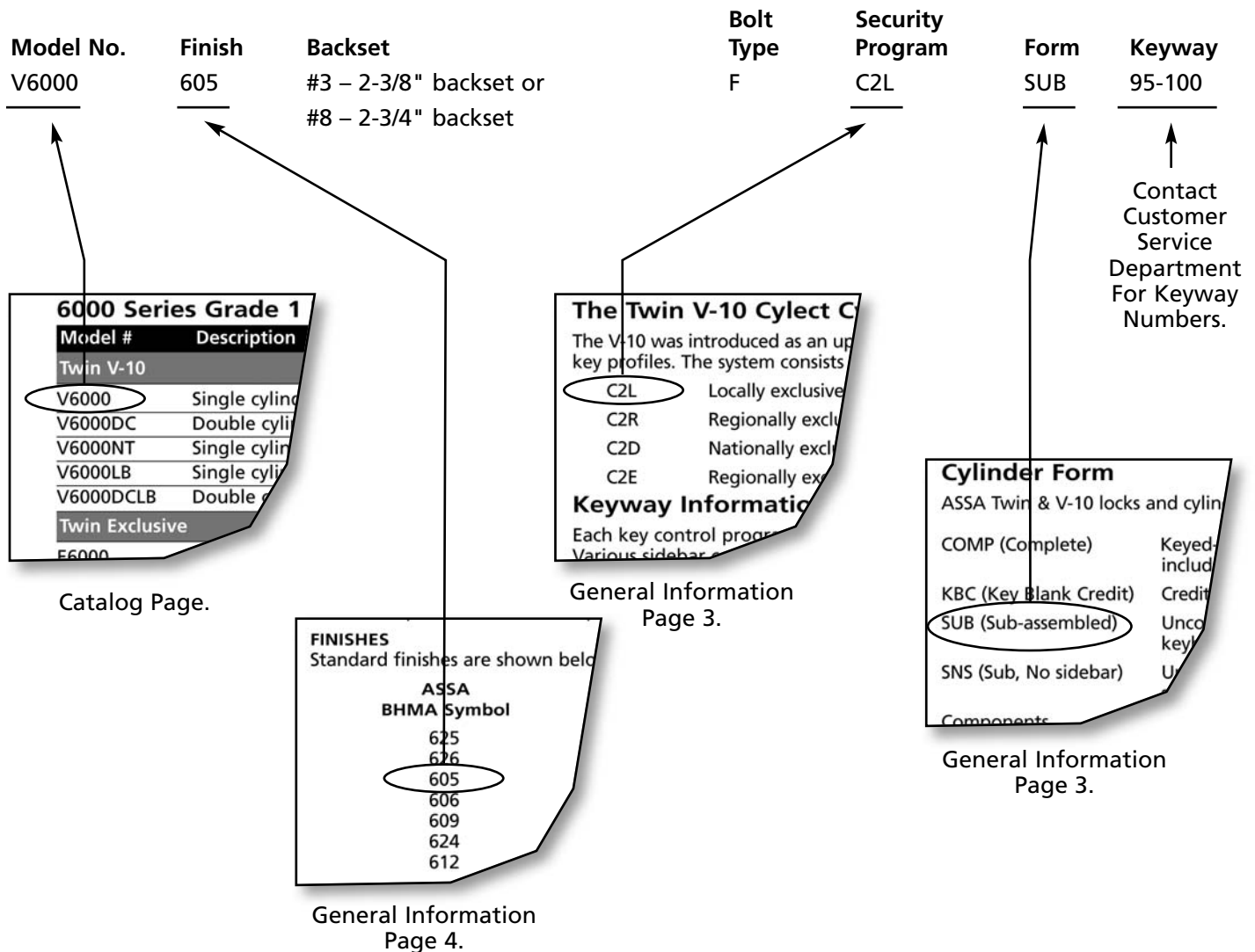

How To Order Deadbolts:

Specify	Model No.	Finish	Backset	Bolt Type	Security Program	Form	Keyway
Example:.....	V60006052-3/8"FC2LSUB95-100

Backset Bolt Type

F - Face Plate
 D - Drive-In

TWIN V-10, TWIN EXCLUSIVE, TWIN PRO, TWIN MAXIMUM, CLIQ

Deadbolts Exploded View



Outside Cylinder

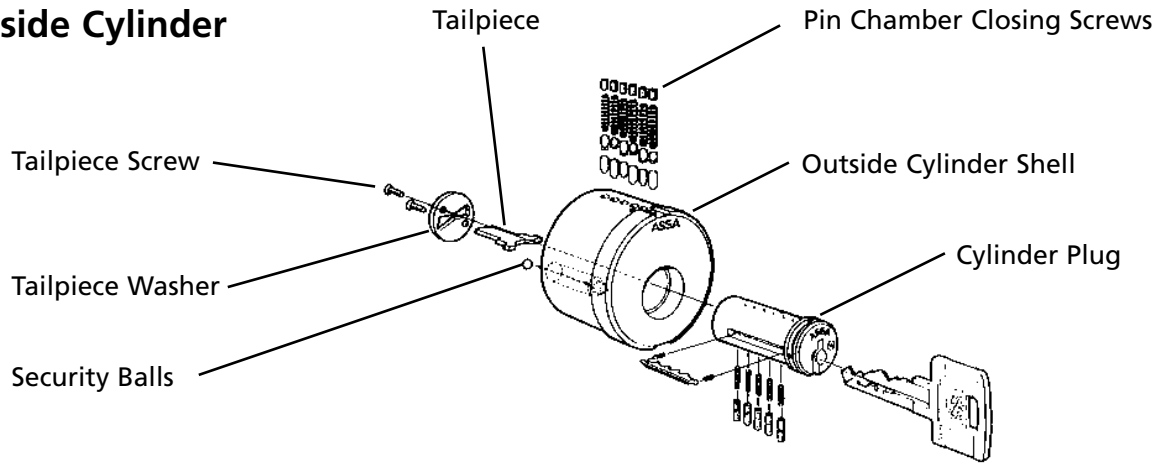

Inside Cylinder

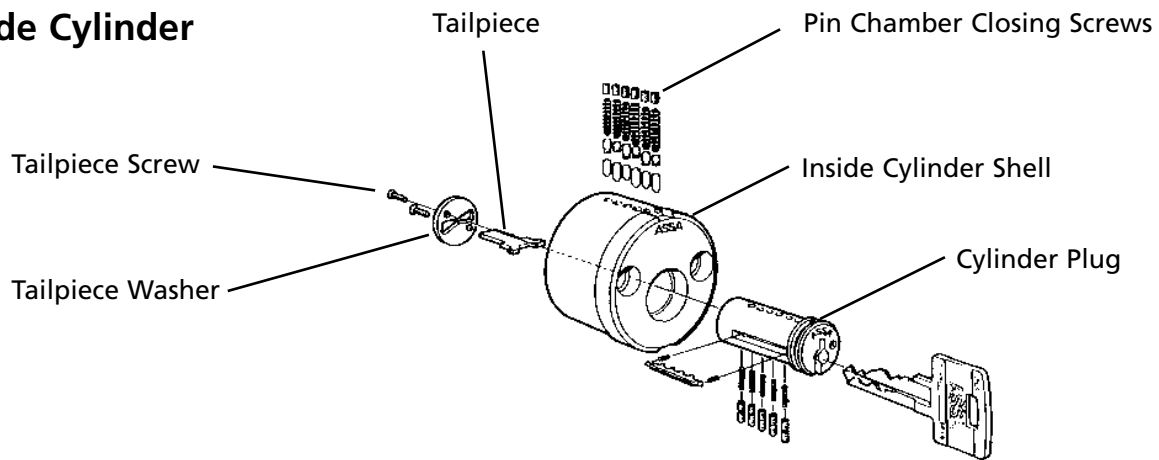

TWIN V-10, TWIN EXCLUSIVE, TWIN PRO, TWIN MAXIMUM, CLIQ

Deadbolts

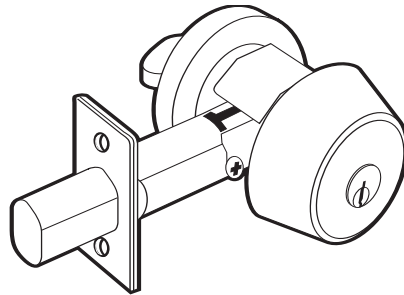





6000 Series Deadbolt

6000 Series Grade 1 Deadbolt Locks

Model #	Description	Comp	Sub	SNS
Twin V-10				
V6000	Single cylinder w/thumbturn	155.00	146.00	141.00
V6000DC	Double cylinder	206.50	197.50	189.00
V6000NT	Single cylinder no thumbturn	137.50	130.00	123.00
V6000LB	Single cylinder less bolt	108.50	101.00	94.00
V6000DCLB	Double cylinder less bolt	160.50	146.00	131.50
Twin Exclusive				
E6000	Single cylinder w/thumbturn	155.00	146.00	141.00
E6000DC	Double cylinder	206.50	197.50	189.00
E6000NT	Single cylinder no thumbturn	137.50	130.00	123.00
E6000LB	Single cylinder less bolt	108.50	101.00	94.00
E6000DCLB	Double cylinder less bolt	160.50	146.00	131.50
Twin 6000 Classic				
6000	Single cylinder w/thumbturn	197.00	187.00	179.00
6000DC	Double cylinder	256.00	238.00	220.00
6000NT	Single cylinder no thumbturn	156.00	147.00	138.00
6000LB	Single cylinder less bolt	124.00	114.00	106.00
6000DCLB	Double cylinder less bolt	183.00	165.00	147.00

6000 Series Grade 1 Deadbolt Locks

Model #	Description	Comp	Sub	SNS
Twin Pro				
6100	Single cylinder w/thumbturn	155.00	146.00	141.00
6100DC	Double cylinder	206.50	197.50	189.00
6100NT	Single cylinder no thumbturn	137.50	130.00	123.00
6100LB	Single cylinder less bolt	108.50	101.00	94.00
6100DCLB	Double cylinder less bolt	160.50	146.00	131.50
Twin Maximum				
8800	 Single cylinder w/thumbturn	155.00	146.00	141.00
8800DC	 Double cylinder	206.50	197.50	189.00
8800NT	 Single cylinder no thumbturn	137.50	130.00	123.00
8800LB	 Single cylinder less bolt	108.50	101.00	94.00
8800DCLB	 Double cylinder less bolt	160.50	146.00	131.50

For extra thick doors of 2" – 2-1/2", please suffix model numbers with -ET.

Example:....V6000-ET ...6052-3/8" backsetF.....C2LSub95-100

 – Twin Maximum available with CLIQ™ Technology, add \$500.00. Example: 8800 x **CLIQ** x 626 x Sidebar x Comp

TWIN V-10, TWIN EXCLUSIVE, TWIN PRO, TWIN MAXIMUM, CLIQ

Deadbolts

600 Series Grade 1 Deadbolt Locks

Model #	Description	Comp	Sub	—
600 Series Classic				
600	Single cylinder w/thumbturn	197.00	187.00	—
600DC	Double cylinder	256.00	238.00	—
600NT	Single cylinder no thumbturn	156.00	147.00	—
600LB	Single cylinder less bolt	124.00	114.00	—
600DCLB	Double cylinder less bolt	183.00	165.00	—

6000 Series Grade 1 Deadbolt Locks Interchangeable Core

Model #	Description	Comp	Sub	SNS
Twin V-10				
V6000IC	Single cylinder IC	180.00	172.50	165.50
V6000ICLC	Double cylinder IC w/thumbturn less core	123.50	—	—
V6000DCIC	Double cylinder IC	280.00	265.00	256.50
V6000DCICLC	Double cylinder IC less core	151.50	—	—
Twin Exclusive				
E6000IC	Single cylinder IC	180.00	172.50	165.50
E6000ICLC	Double cylinder IC w/thumbturn less core	123.50	—	—
E6000DCIC	Double cylinder IC	280.00	265.00	256.50
E6000DCICLC	Double cylinder IC less core	151.50	—	—
Twin 6000 Classic				
6000IC	Single cylinder IC	212.00	202.00	194.00
6000ICLC	Double cylinder IC w/thumbturn less core	146.00	—	—
6000DCIC	Double cylinder IC	305.00	286.00	276.00
6000DCICLC	Double cylinder IC less core	179.00	—	—

6000 Series Grade 1 Deadbolt Locks Interchangeable Core

Model #	Description	Comp	Sub	SNS
Twin Pro				
6100IC	Single cylinder IC	180.00	172.50	165.50
6100ICLC	Double cylinder IC w/thumbturn less core	123.50	—	—
6100DCIC	Double cylinder IC	280.00	265.00	256.50
6100DCICLC	Double cylinder IC less core	151.50	—	—
Twin Maximum				
8800IC	Single cylinder IC	180.00	172.50	165.50
8800ICLC	Double cylinder IC w/thumbturn less core	123.50	—	—
8800DCIC	Double cylinder IC	280.00	265.00	256.50
8800DCICLC	Double cylinder IC less core	151.50	—	—

For extra thick doors of 2" – 2-1/2", please suffix model numbers with -ET.

Example:....V6000-ET ...6052-3/8" backsetF.....C2LSub95-100

 – Twin Maximum available with CLIQ™ Technology, add \$500.00. Example: 8800IC x **CLIQ** x 626 x Sidebar x Comp

TWIN V-10, TWIN EXCLUSIVE, TWIN PRO, TWIN MAXIMUM, CLIQ

Deadbolts

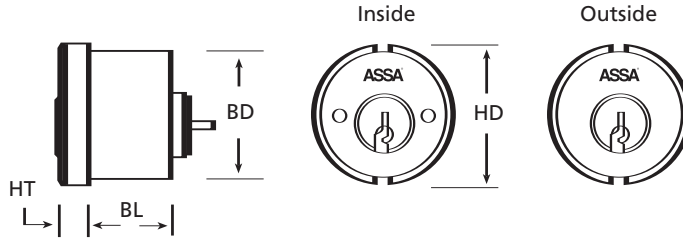

6000 Series Deadbolt Cylinders Only

Model #	Description	HT	BL	BD	HD	Comp	Sub	SNS
Twin V-10								
V65811	Outside cylinder	0.323	0.920	1.440	1.572	105.00	97.50	90.50
V65812	Inside cylinder	0.323	0.920	1.440	1.572	105.00	97.50	90.50
V65813	Inside & Outside cylinder	0.323	0.920	1.440	1.572	198.00	183.00	169.00
V65811IC	Outside IC cylinder	0.323	0.920	1.440	1.572	173.00	165.50	158.50
V65812IC	Inside IC cylinder	0.323	0.920	1.440	1.572	173.00	165.50	158.50
V65813IC	Inside & Outside IC cylinder	0.323	0.920	1.440	1.572	333.00	318.50	304.00
V65811ICLC	Outside IC cylinder less core	0.323	0.920	1.440	1.572	82.50	—	—
V65812ICLC	Inside IC cylinder less core	0.323	0.920	1.440	1.572	82.50	—	—
V65813ICLC	Inside & Outside IC cylinder less core	0.323	0.920	1.440	1.572	165.00	—	—
Twin Exclusive								
E65811	Outside cylinder	0.323	0.920	1.440	1.572	105.00	97.50	90.50
E65812	Inside cylinder	0.323	0.920	1.440	1.572	105.00	97.50	90.50
E65813	Inside & Outside cylinder	0.323	0.920	1.440	1.572	198.00	183.00	169.00
E65811IC	Outside IC cylinder	0.323	0.920	1.440	1.572	173.00	165.50	158.50
E65812IC	Inside IC cylinder	0.323	0.920	1.440	1.572	173.00	165.50	158.50
E65813IC	Inside & Outside IC cylinder	0.323	0.920	1.440	1.572	333.00	318.50	304.00
E65811ICLC	Outside IC cylinder less core	0.323	0.920	1.440	1.572	82.50	—	—
E65812ICLC	Inside IC cylinder less core	0.323	0.920	1.440	1.572	82.50	—	—
E65813ICLC	Inside & Outside IC cylinder less core	0.323	0.920	1.440	1.572	165.00	—	—
Twin 6000 Classic								
65811	Outside cylinder	0.323	0.920	1.440	1.572	120.00	111.00	102.00
65812	Inside cylinder	0.323	0.920	1.440	1.572	120.00	111.00	102.00
65813	Inside & Outside cylinder	0.323	0.920	1.440	1.572	226.00	217.00	190.00
65811IC	Outside IC cylinder	0.323	0.920	1.440	1.572	203.50	193.50	185.50
65812IC	Inside IC cylinder	0.323	0.920	1.440	1.572	203.50	193.50	185.50
65813IC	Inside & Outside IC cylinder	0.323	0.920	1.440	1.572	392.50	374.50	356.50
65811ICLC	Outside IC cylinder less core	0.323	0.920	1.440	1.572	97.00	—	—
65812ICLC	Inside IC cylinder less core	0.323	0.920	1.440	1.572	97.00	—	—
65813ICLC	Inside & Outside IC cylinder less core	0.323	0.920	1.440	1.572	194.00	—	—

For extra thick doors of 2" – 2-1/2", please suffix model numbers with -ET.

Example:....V65811-ET.....6052-3/8" backset.....F.....C2LSub95-100

TWIN V-10, TWIN EXCLUSIVE, TWIN PRO, TWIN MAXIMUM, CLIQ

Deadbolts

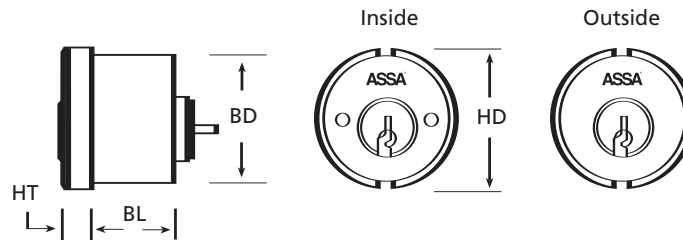

6000 Series Deadbolt Cylinders Only

Model #	Description	HT	BL	BD	HD	Comp	Sub	SNS
Twin Pro								
6181	Outside cylinder	0.323	0.920	1.440	1.572	105.00	97.50	90.50
6182	Inside cylinder	0.323	0.920	1.440	1.572	105.00	97.50	90.50
6183	Inside & Outside cylinder	0.323	0.920	1.440	1.572	198.00	183.00	169.00
6181IC	Outside IC cylinder	0.323	0.920	1.440	1.572	173.00	165.50	158.50
6182IC	Inside IC cylinder	0.323	0.920	1.440	1.572	173.00	165.50	158.50
6183IC	Inside & Outside IC cylinder	0.323	0.920	1.440	1.572	333.00	318.50	304.00
6181ICLC	Outside IC cylinder less core	0.323	0.920	1.440	1.572	82.50	—	—
6182ICLC	Inside IC cylinder less core	0.323	0.920	1.440	1.572	82.50	—	—
6183ICLC	Inside & Outside IC cylinder less core	0.323	0.920	1.440	1.572	165.00	—	—
Twin Maximum								
8881	Outside cylinder	0.323	0.920	1.440	1.572	105.00	97.50	90.50
8882	Inside cylinder	0.323	0.920	1.440	1.572	105.00	97.50	90.50
8883	Inside & Outside cylinder	0.323	0.920	1.440	1.572	198.00	183.00	169.00
8881IC	Outside IC cylinder	0.323	0.920	1.440	1.572	173.00	165.50	158.50
8882IC	Inside IC cylinder	0.323	0.920	1.440	1.572	173.00	165.50	158.50
8883IC	Inside & Outside IC cylinder	0.323	0.920	1.440	1.572	333.00	318.50	304.00
8881ICLC	Outside IC cylinder less core	0.323	0.920	1.440	1.572	82.50	—	—
8882ICLC	Inside IC cylinder less core	0.323	0.920	1.440	1.572	82.50	—	—
8883ICLC	Inside & Outside IC cylinder less core	0.323	0.920	1.440	1.572	165.00	—	—

600 Series Deadbolt Cylinders Only

Model #	Description	HT	BL	BD	HD	Comp	Sub	SNS
600 Series Classic								
6811	Outside cylinder	0.323	0.920	1.440	1.572	114.00	105.00	—
6812	Inside cylinder	0.323	0.920	1.440	1.572	114.00	105.00	—
6813	Inside & Outside cylinder	0.323	0.920	1.440	1.572	215.00	196.00	—

For extra thick doors of 2" – 2-1/2", please suffix model numbers with -ET.

Example:.....6181-ET6052-3/8" backset.....F.....C2LSub95-100

– Twin Maximum available with CLIQ™ Technology, add \$500.00. Example: 8881 x **CLIQ** x 626 x Sidebar x Comp

TWIN V-10, TWIN EXCLUSIVE, TWIN PRO, TWIN MAXIMUM, CLIQ

Deadbolts Component Parts

- A. Cylinder and Thumbturn Cap
- B. Ball Bearing Insert
- C. Cylinder (DC) Mounting Bolts (2-1/4")
- D. Inside Cylinder
- E. Cylinder Ring
- F. Faceplate Bolt
- G. Wood/Metal Combination Screws
- H. Screws for Hardhat
- I. Hardhat
- J. Outside Cylinder

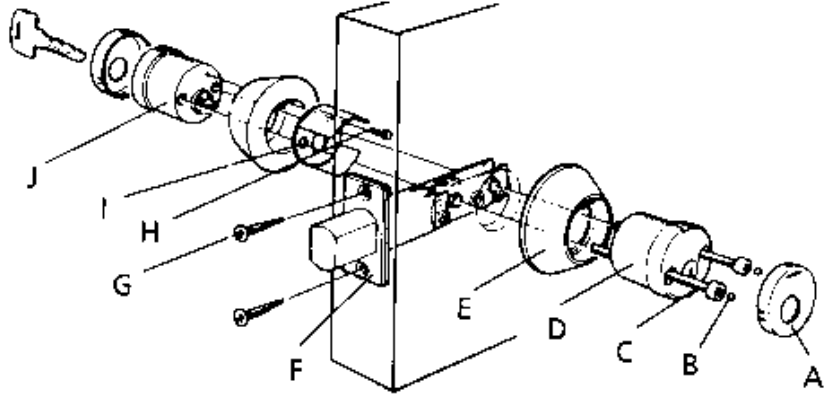

Deadbolts Parts

Model No.	Description	Price
352323	Outside Cylinder Shell	34.00
352324	Inside Cylinder Shell	30.00
* 352326	Thumbturn	34.50
* 353969	Twin V-10 Cylinder Plug	27.00
* 356071	Twin Exclusive Cylinder Plug	27.00
* 816068	Twin Pro / Twin Maximum Cylinder Plug†	27.00
* 442774	Deadbolt Bolt Faceplate	76.00
* 907001	2-3/4" Faceplate Bolt	76.00
* 907002	2-3/4" Drive-In Bolt	76.00
* 907003	2-3/8" Faceplate Bolt	76.00
* 907004	2-3/8" Drive-In Bolt	76.00
* 907005	Strike Plate with Screws	14.50
907007	Reinforced Strike Box and Screws	17.50
907008	Security Bolt Guard Plate	3.00
806263	Thumbturn Tailpiece bushing	2.75
352325	Thumbturn Housing Only	33.00
806265	Thumbturn Spindle	22.50
* 806266	Cylinder Thumbturn Cap	2.25
* 806266NT	Cylinder Cap, No Thumbturn	4.50
806256	IC Cylinder and Thumbturn Cap	4.50
* 806267	Cylinder Ring	29.50
806269	Adapter Ring 2-1/8" Side Hole	18.50
* 806268	Spacer Ring 1-3/8" Door	23.00
* 806270	Thumbturn Ring	26.00
806346	Pin Chamber Closing Screws	.75
806483	Thumbturn Set Screws	1.00
867046	Tailpiece Washer	3.50
867090	Tailpiece Screw	1.00
806262	Tailpiece	2.00
867109	Tailpiece for Special Door Thickness	6.00
907015	Security Balls for Single & Double Cylinder	1.00
907010	Deadbolt Mounting Bolts (Std. Single Cyl.)	1.00
907011	Deadbolt Mounting Bolts (Std. Double cyl.)	1.25
907012	Deadbolt mounting Bolts (3")	1.75
907013	Deadbolt Mounting Bolts (3-1/4")	2.50
907016	Deadbolt Strike Box Screw	.75
907035	Deadbolt Chamber Screw Wrench	.75

* – Indicates Finished Components.

† – Specify Profile 0P4 for Twin Pro or 0M7 for Twin Maximum.

TWIN V-10, TWIN EXCLUSIVE, TWIN PRO, TWIN MAXIMUM, CLIQ

Auxiliary Locks

ASSA's auxiliary lock line brings the same level of patented key control and durability to cam locks, window locks, drawer and desk locks, and tube locks that are standard for all of our high security products. All of our auxiliary locks can be keyed into an existing or new master key system and are operated by the same 6 pin uniquely side coded keys as the rest of our high security line eliminating the need for maintaining separate key systems.

**Benefits:**

- All locks operated by the same high security key
- Unlimited number of applications
- Two independent locking mechanisms to ensure security and optimum pick resistance
- Inactive "false" grooves on side pins designed to catch picking tools
- Can be easily rekeyed in the field
- Patented key control

Warranty:

- ASSA guarantees its products against defective workmanship or wear resulting from defects for life

Technical Information:

- Cylinder housing and plug made of high quality brass
- Stainless steel top pins
- Bottom pins and master pins are nickel silver

Cam Locks

ASSA manufactures the most rugged high security cam locks on the market today. The sturdy design makes it perfect for inner safe doors and compartments, cash storage containers, drug carts, gun cabinets, alarm control panels, and key storage cabinets. ASSA cam locks are operated with the same ASSA 6 pin high security key as the rest of our product offering and are available in both key retaining and non-key retaining models.



Benefits:

- Operated by 6 pin high security key
- Available in key retaining and non-key retaining
- 31 different catches available
- Two independent locking mechanisms to ensure security and optimum pick resistance
- Inactive "false" grooves on side pins designed to catch picking tools
- Patented key control

Warranty:

- ASSA guarantees its products against defective workmanship or wear resulting from defects for life

Certification:

- UL 437 (Pending)

Technical Information:

- Installation prep 22 mm, 7/8" Double "D" (punch available from ASSA)
- Uses hollowed out interchangeable core drivers
- Body and plug chromium plated brass
- Stainless steel top pins
- Bottom pins and master pins are nickel silver

Finishes:

<u>BHMA Symbol</u>	<u>U.S. Symbol</u>	<u>Euro Finish</u>	<u>Description</u>
625	US 26	11	Bright Chrome

TWIN V-10, TWIN EXCLUSIVE, TWIN PRO, TWIN MAXIMUM, CLIQ

Utility Locks

This is truly an innovative lock assembly. A rugged cast aluminum housing and strike assembly holds a solid brass six pin high security cylinder. ASSA Utility Locks are used to secure sliding glass or wood doors, storage cabinets, and windows.

They can be keyed into any ASSA key system or used as a stand alone locking device. The body is finished with baked on white enamel. This assembly locks with just one push of your thumb or finger, as easy as locking a file cabinet. The Utility Lock comes with all of its own mounting hardware for standard wood frame applications and shims for uneven surfaces.



Benefits:

- 6 pin high security cylinder
- Two independent locking mechanisms to ensure security and optimum pick resistance
- Inactive "false" grooves on side pins designed to catch picking tools
- Patented key control

Warranty:

- ASSA guarantees its products against defective workmanship or wear resulting from defects for life

Certification:

- UL 437 (Pending)

Technical Information:

- Cast aluminum housing
- Cast aluminum rim and mortise strike
- Cylinder body and plug high quality brass
- Stainless steel top pins
- Bottom pins and master pins are nickel silver

TWIN V-10, TWIN EXCLUSIVE, TWIN PRO, TWIN MAXIMUM, CLIQ

Cabinet Locks

ASSA manufactures the finest quality cabinet and desk locks featuring our high security eleven pin cylinders. These locks are listed with Underwriters Laboratories as U.L. 437. Our cabinet and desk locks can be keyed into any ASSA master key system. The cylinder can be easily rekeyed by removing the setscrew on the side of the cylinder housing.



700AS – 138



800AS – 138



850AS – 078



850AS – 138

Benefits:

- ASSA U.L. 437 high security cylinder
- Setscrew for easy rekeying
- Two independent locking mechanisms to ensure security and optimum pick resistance
- Inactive "false" grooves on side pins designed to catch picking tools
- Patented key control

Warranty:

- ASSA guarantees its products against defective workmanship or wear resulting from defects for life

Certification:

- All ASSA Cabinet/Drawer lock cylinders are U.L. 437 listed

Technical Information:

- Available with plastic spacer and strike
- Cabinet lock available with horizontal or vertical bolt
- Desk lock available in 7/8" and 1-3/8" mounting thickness
- Bolt material high quality brass
- Stainless steel top pins
- Bottom pins and master pins are nickel silver

Finishes:

<u>BHMA Symbol</u>	<u>U.S. Symbol</u>	<u>Euro Finishes</u>	<u>Description</u>
626	US 26D	13	Satin Chrome
605	US 3	20	Bright Brass

TWIN V-10, TWIN EXCLUSIVE, TWIN PRO, TWIN MAXIMUM, CLIQ

Keyswitch Locks

The ASSA Switch Lock is the newest addition to our family of high security products. Combining state-of-the-art Securitron® designed electronic technology with the versatility of an ASSA high security non-key retaining cam lock, this product is the key switch of the future. The switch lock is fully reversible from maintained to momentary and can be integrated into any new or existing ASSA master key system.



Benefits:

- Long operating life
- Elongated mounting hole for easier, more accurate mounting
- Choice of actuation (plunger as well as a variety of integral and auxiliary actuators)
- Choice of electrical termination (solder, quick connect, PCB)
- Available with standard or narrow stile mounting plate with LED
- Patented key control

Warranty:

- ASSA guarantees its products against defective workmanship or wear resulting from defects for life

Technical Information:

- Single pull double throw (SPDT) pin actuator and solder termination standard
- 3 amp at 12 or 24 VDC
- Uses hollowed out interchangeable core drivers
- Body and plug chromium plated brass
- Stainless steel top pins
- Bottom pins and master pins are nickel silver

Finishes:

<u>BHMA Symbol</u>	<u>U.S. Symbol</u>	<u>Euro Finishes</u>	<u>Description</u>
626	US 26D	13	Satin Chrome

TWIN V-10, TWIN EXCLUSIVE, TWIN PRO, TWIN MAXIMUM, CLIQ

Auxiliary Locks Ordering Information

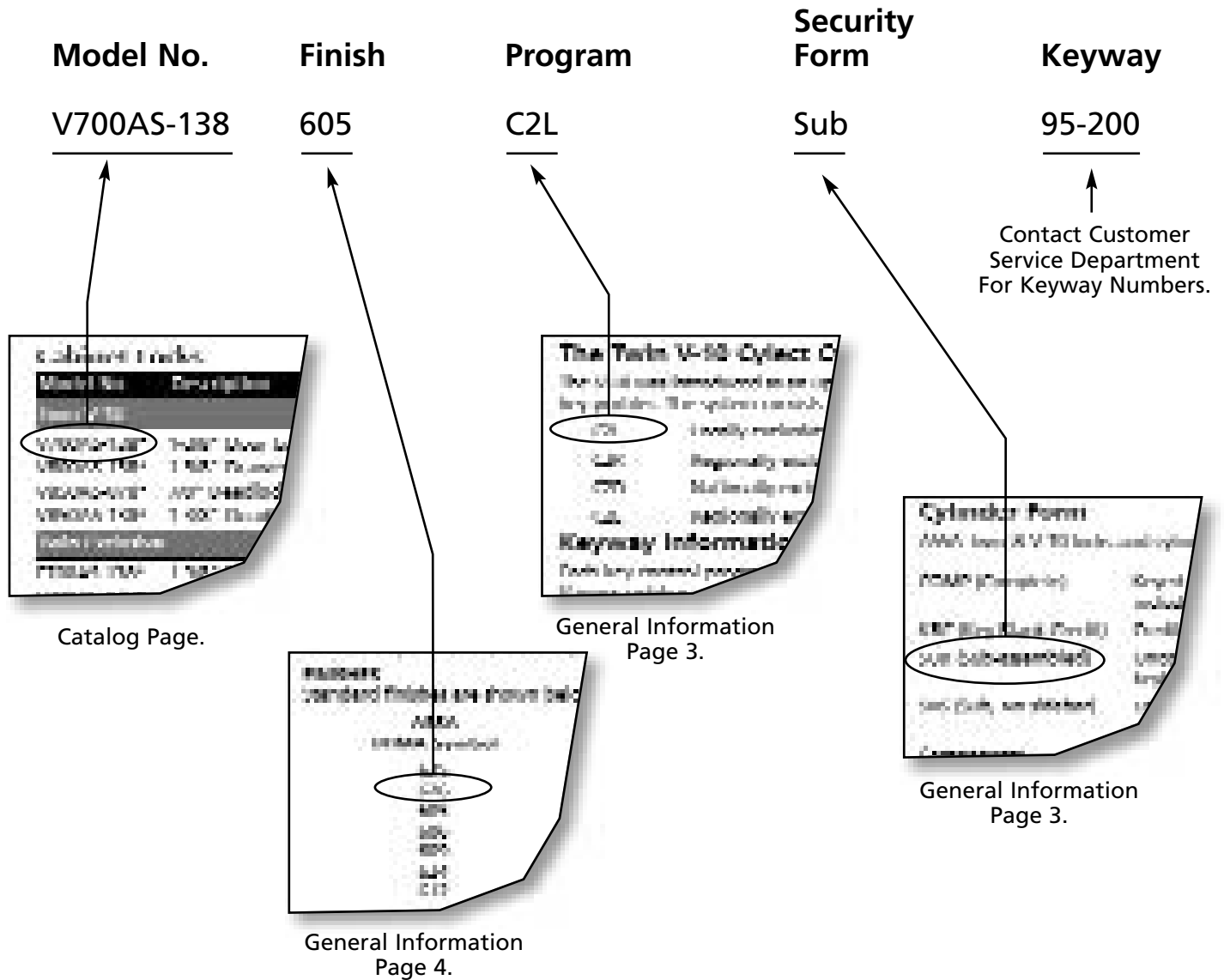

How To Order Auxiliary Locks:

Specify	Model No.	Security Program	Form	Keyway
---------	-----------	------------------	------	--------

Example:.....V6571C2L.....SUB95-100

TWIN V-10, TWIN EXCLUSIVE, TWIN PRO, TWIN MAXIMUM, CLIQ

Auxiliary Locks Exploded Views

Tube Locks

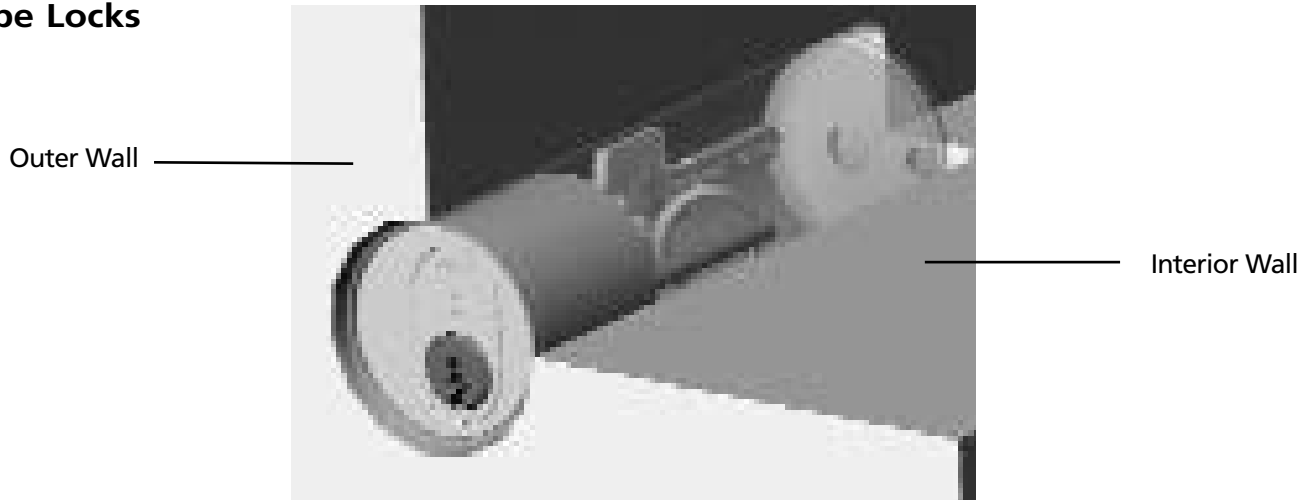

Cam Locks

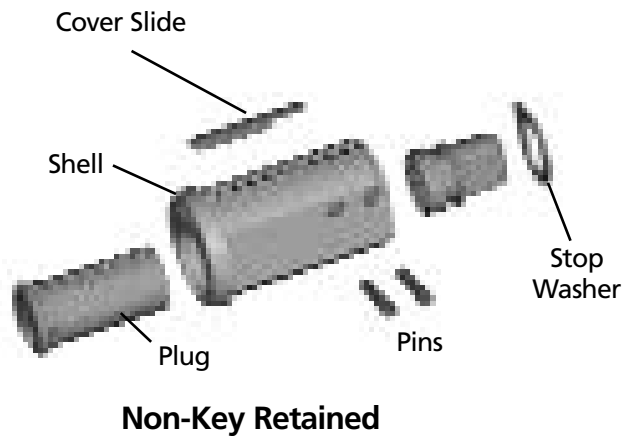
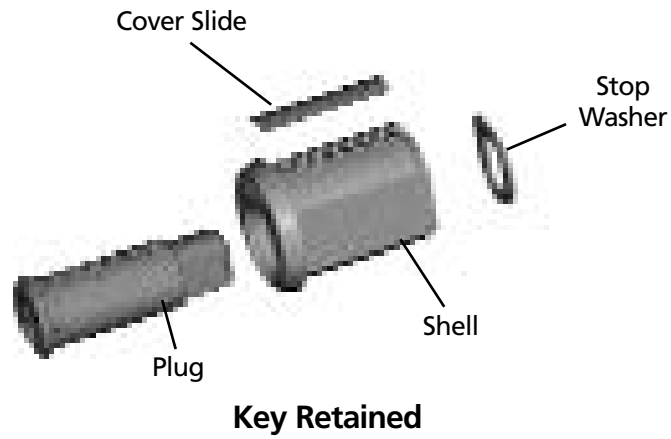

TWIN V-10, TWIN EXCLUSIVE, TWIN PRO, TWIN MAXIMUM, CLIQ

Auxiliary Locks Exploded Views

Utility Locks

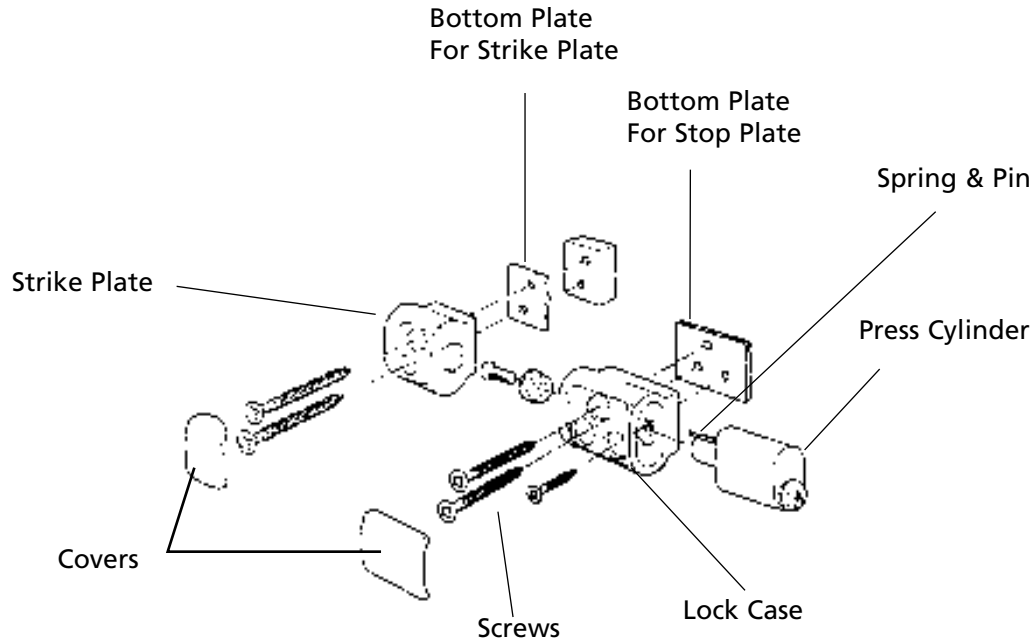

Switch Locks

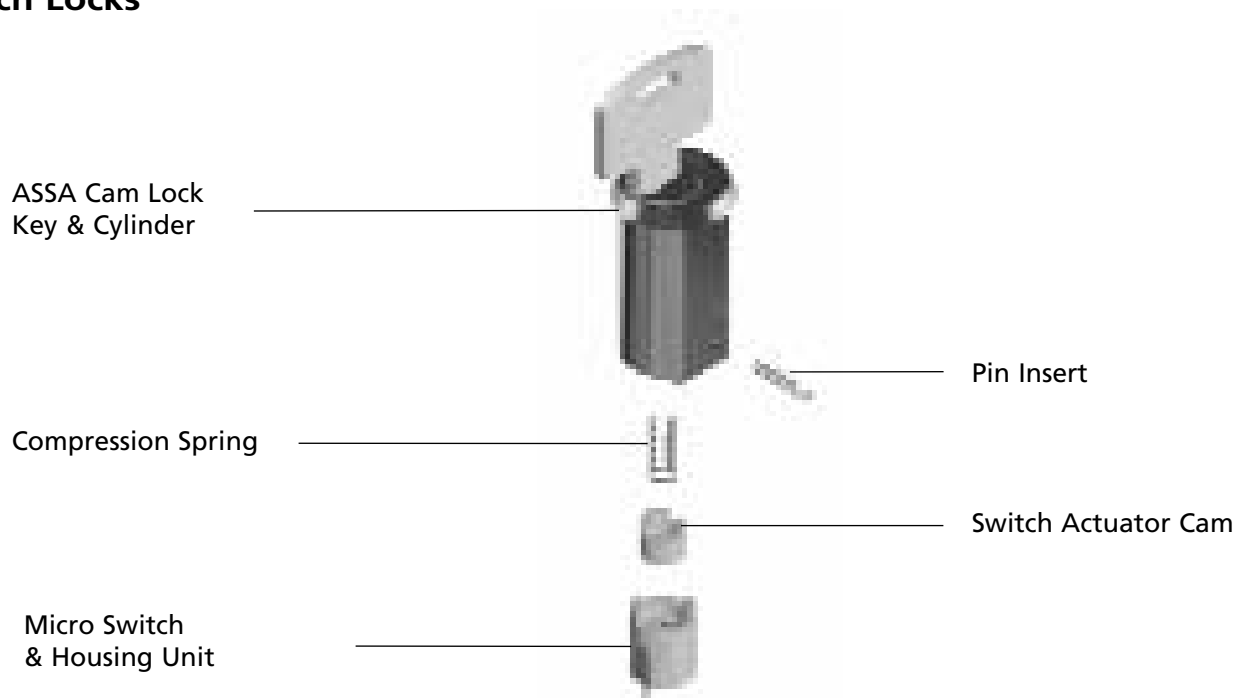

TWIN V-10, TWIN EXCLUSIVE, TWIN PRO, TWIN MAXIMUM, CLIQ

Auxiliary Locks



Tube Lock

Model No.	Description	Comp	Sub	SNS
Twin V-10				
V65617	Wall Tube Lock	121.50	114.00	107.00
Twin Exclusive				
E65617	Wall Tube Lock	121.50	114.00	107.00
Twin 6000 Classic				
65617	Wall Tube Lock	137.50	128.50	119.50
Twin Pro				
61617	Wall Tube Lock	121.50	114.00	107.00
Twin Maximum				
88617	Wall Tube Lock	121.50	114.00	107.00

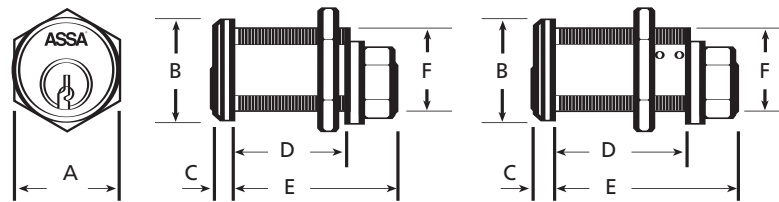

Cam Locks

Model	Description	A	B	C	D	E	F	Comp	Sub	SNS
Twin V-10										
V6571	Key Retaining Cam Lock 90°	1.025	0.980	0.110	1.070	1.490	0.860	43.50	35.75	29.00
V7571	Non-Key Retaining Cam Lock 360°	1.025	0.980	0.150	1.510	1.865	0.860	48.50	40.75	34.00
Twin Exclusive										
E6571	Key Retaining Cam Lock 90°	1.025	0.980	0.110	1.070	1.490	0.860	43.50	35.75	29.00
E7571	Non-Key Retaining Cam Lock 360°	1.025	0.980	0.150	1.510	1.865	0.860	48.50	40.75	34.00
Twin 6000 Classic										
6571	Key Retaining Cam Lock 90°	1.025	0.980	0.110	1.070	1.490	0.860	51.00	41.00	32.00
7571	Non-Key Retaining Cam Lock 360°	1.025	0.980	0.150	1.510	1.865	0.860	57.00	47.00	39.00
Twin Pro										
6171	Key Retaining Cam Lock 90°	1.025	0.980	0.110	1.070	1.490	0.860	43.50	35.75	29.00
7171	Non-Key Retaining Cam Lock 360°	1.025	0.980	0.150	1.510	1.865	0.860	48.50	40.75	34.00
Twin Maximum										
8871	Key Retaining Cam Lock 90°	1.025	0.980	0.110	1.070	1.490	0.860	43.50	35.75	29.00
8872	Non-Key Retaining Cam Lock 360°	1.025	0.980	0.150	1.510	1.865	0.860	48.50	40.75	34.00
Twin Maximum Medium Security										
2871	Key Retaining Cam Lock 90°	1.025	0.980	0.110	1.070	1.490	0.860	36.00	30.00	24.00
2872	Non-Key Retaining Cam Lock 360°	1.025	0.980	0.150	1.510	1.865	0.860	40.00	33.50	28.00

– Twin Maximum available with CLIQ™ Technology, add \$500.00. Example: 8871 x **CLIQ** x 626 x Sidebar x Comp

TWIN V-10, TWIN EXCLUSIVE, TWIN PRO, TWIN MAXIMUM, CLIQ

Auxiliary Locks

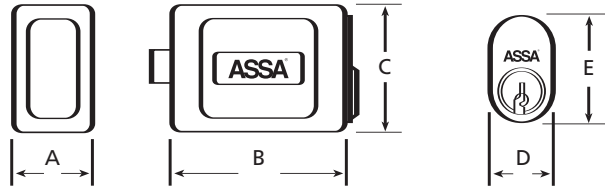

Utility Locks

Model No.	Description	A	B	C	D	E	Comp	Sub	SNS
Twin V-10									
V7680	Utility Lock	0.970	0.460	1.345	0.670	1.115	59.50	51.75	45.00
Twin Exclusive									
E7680	Utility Lock	0.970	0.460	1.345	0.670	1.115	59.50	51.75	45.00
Twin 6000 Classic									
7680	Utility Lock	0.970	0.460	1.345	0.670	1.115	67.00	58.00	49.00
Twin Pro									
6180	Utility Lock	0.970	0.460	1.345	0.670	1.115	59.50	51.75	45.00
Twin Maximum									
8880	Utility Lock	0.970	0.460	1.345	0.670	1.115	59.50	51.75	45.00

TWIN V-10, TWIN EXCLUSIVE, TWIN PRO, TWIN MAXIMUM, CLIQ

Auxiliary Locks

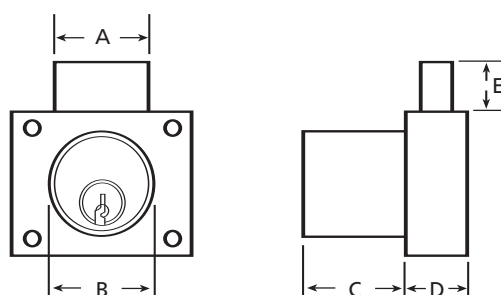

Cabinet Locks

Model No.	Description	A	B	C	D	E	Comp	Sub	SNS
Twin V-10									
V700AS-138*	1-3/8" Door Lock	1.010	1.120	1.420	0.515	0.965	83.00	75.25	68.50
V800AS-138*	1-3/8" Drawer Lock	1.010	1.120	1.420	0.515	0.965	83.00	75.25	68.50
V850AS-078*	7/8" Deadlocking Latch	1.000	1.120	1.185	0.635	0.320	100.00	92.25	85.50
V850AS-138*	1-3/8" Deadlocking Latch	1.010	1.120	1.420	0.515	0.965	102.00	94.25	87.50
Twin Exclusive									
E700AS-138*	1-3/8" Door Lock	1.010	1.120	1.420	0.515	0.965	83.00	75.25	68.50
E800AS-138*	1-3/8" Drawer Lock	1.010	1.120	1.420	0.515	0.965	83.00	75.25	68.50
E850AS-078*	7/8" Deadlocking Latch	1.000	1.120	1.185	0.635	0.320	100.00	92.25	85.50
E850AS-138*	1-3/8" Deadlocking Latch	1.010	1.120	1.420	0.515	0.965	102.00	94.25	87.50
Twin 6000 Classic									
700AS-138*	1-3/8" Door Lock	1.010	1.120	1.420	0.515	0.965	93.50	84.50	75.50
800AS-138*	1-3/8" Drawer Lock	1.010	1.120	1.420	0.515	0.965	93.50	84.50	75.50
850AS-078*	7/8" Deadlocking Latch	1.000	1.120	1.185	0.635	0.320	113.50	103.50	95.50
850AS-138*	1-3/8" Deadlocking Latch	1.010	1.120	1.420	0.515	0.965	115.50	105.50	97.50
Twin Pro									
61700AS-138*	1-3/8" Door Lock	1.010	1.120	1.420	0.515	0.965	83.00	75.25	68.50
61800AS-138*	1-3/8" Drawer Lock	1.010	1.120	1.420	0.515	0.965	83.00	75.25	68.50
61850AS-078*	7/8" Deadlocking Latch	1.000	1.120	1.185	0.635	0.320	100.00	92.25	85.50
61850AS-138*	1-3/8" Deadlocking Latch	1.010	1.120	1.420	0.515	0.965	102.00	94.25	87.50
Twin Maximum									
88700AS-138*	1-3/8" Door Lock	1.010	1.120	1.420	0.515	0.965	83.00	75.25	68.50
88800AS-138*	1-3/8" Drawer Lock	1.010	1.120	1.420	0.515	0.965	83.00	75.25	68.50
88850AS-078*	7/8" Deadlocking Latch	1.000	1.120	1.185	0.635	0.320	100.00	92.25	85.50
88850AS-138*	1-3/8" Deadlocking Latch	1.010	1.120	1.420	0.515	0.965	102.00	94.25	87.50



– Twin Maximum available with CLIQ™ Technology, add \$500.00. Example: 88700AS-138 x **CLIQ** x 626 x Sidebar x Comp
 * Indicate product finish, Cabinet locks are available in 605 & 626 only.

TWIN V-10, TWIN EXCLUSIVE, TWIN PRO, TWIN MAXIMUM, CLIQ

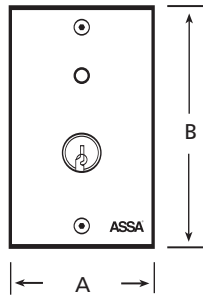
Auxiliary Locks



Keyswitches With Single Gang Plate

Model No.	Description	A	B	Comp	Sub	SNS
Twin V-10						
V7700	Single Gang Plate Bi/LED Momentary	2.75	4.50	196.00	188.50	181.50
V7771	Single Gang Plate Bi/LED On/Off	2.75	4.50	196.00	188.50	181.50
Twin Exclusive						
E7700	Single Gang Plate Bi/LED Momentary	2.75	4.50	196.00	188.50	181.50
E7771	Single Gang Plate Bi/LED On/Off	2.75	4.50	196.00	188.50	181.50
Twin 6000 Classic						
7700	Single Gang Plate Bi/LED Momentary	2.75	4.50	222.50	213.50	204.50
7771	Single Gang Plate Bi/LED On/Off	2.75	4.50	222.50	213.50	204.50
Twin Pro						
6700	Single Gang Plate Bi/LED Momentary	2.75	4.50	196.00	188.50	181.50
6771	Single Gang Plate Bi/LED On/Off	2.75	4.50	196.00	188.50	181.50
Twin Maximum						
8870-SG 	Single Gang Plate Bi/LED Momentary	2.75	4.50	196.00	188.50	181.50
8871-SG 	Single Gang Plate Bi/LED On/Off	2.75	4.50	196.00	188.50	181.50

 – Twin Maximum available with CLIQ™ Technology, add \$500.00. Example: **8870-SG** x **CLIQ** x **626** x **Sidebar** x **Comp**

TWIN V-10, TWIN EXCLUSIVE, TWIN PRO, TWIN MAXIMUM, CLIQ

Auxiliary Locks

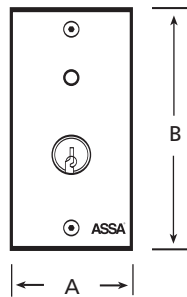

Keyswitches With Narrow Stile Plate

Model No.	Description	A	B	Comp	Sub	SNS
Twin V-10						
V7700-N	Narrow Stile Plate Bi/LED Momentary	1.75	4.50	178.50	171.00	164.00
V7771-N	Narrow Stile Plate Bi/LED On/Off	1.75	4.50	178.50	171.00	164.00
Twin Exclusive						
E7700-N	Narrow Stile Plate Bi/LED Momentary	1.75	4.50	178.50	171.00	164.00
E7771-N	Narrow Stile Plate Bi/LED On/Off	1.75	4.50	178.50	171.00	164.00
Twin 6000 Classic						
7700-N	Narrow Stile Plate Bi/LED Momentary	1.75	4.50	222.50	213.50	204.50
7771-N	Narrow Stile Plate Bi/LED On/Off	1.75	4.50	222.50	213.50	204.50
Twin Pro						
6700-N	Narrow Stile Plate Bi/LED Momentary	1.75	4.50	178.50	171.00	164.00
6771-N	Narrow Stile Plate Bi/LED On/Off	1.75	4.50	178.50	171.00	164.00
Twin Maximum						
8870-N	Narrow Stile Plate Bi/LED Momentary	1.75	4.50	178.50	171.00	164.00
8871-N	Narrow Stile Plate Bi/LED On/Off	1.75	4.50	178.50	171.00	164.00



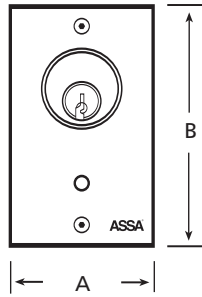

– Twin Maximum available with CLIQ™ Technology, add \$500.00. Example: **8870-N** x **CLIQ** x **626** x **Sidebar** x **Comp**

TWIN V-10, TWIN EXCLUSIVE, TWIN PRO, TWIN MAXIMUM, CLIQ

Auxiliary Locks



Mortise Keyswitches With Single Gang Plate

Model No.	Description	A	B	Comp	Sub	SNS
Twin V-10						
V6551MKS*	Single Gang Plate Mortise Bi/LED with One SPDT Momentary Switch	2.75	4.50	212.50	203.00	196.00
V6551MKSA*	Single Gang Plate Mortise Bi/LED with One SPDT Alternate - On/Off Switch	2.75	4.50	212.50	203.00	196.00
V6551MKS2*	Single Gang Plate Mortise Bi/LED with One DPDT Momentary Switch	2.75	4.50	212.50	203.00	196.00
V6551MKS2A*	Single Gang Plate Mortise Bi/LED with One DPDT Alternate - On/Off Switch	2.75	4.50	212.50	203.00	196.00
Twin Exclusive						
E6551MKS*	Single Gang Plate Mortise Bi/LED with One SPDT Momentary Switch	2.75	4.50	212.50	203.00	196.00
E6551MKSA*	Single Gang Plate Mortise Bi/LED with One SPDT Alternate - On/Off Switch	2.75	4.50	212.50	203.00	196.00
E6551MKS2*	Single Gang Plate Mortise Bi/LED with One DPDT Momentary Switch	2.75	4.50	212.50	203.00	196.00
E6551MKS2A*	Single Gang Plate Mortise Bi/LED with One DPDT Alternate - On/Off Switch	2.75	4.50	212.50	203.00	196.00
Twin 6000 Classic						
6551MKS*	Single Gang Plate Mortise Bi/LED with One SPDT Momentary Switch	2.75	4.50	212.50	203.00	196.00
6551MKSA*	Single Gang Plate Mortise Bi/LED with One SPDT Alternate - On/Off Switch	2.75	4.50	212.50	203.00	196.00
6551MKS2*	Single Gang Plate Mortise Bi/LED with One DPDT Momentary Switch	2.75	4.50	212.50	203.00	196.00
6551MKS2A*	Single Gang Plate Mortise Bi/LED with One DPDT Alternate - On/Off Switch	2.75	4.50	212.50	203.00	196.00
Twin Pro						
6151MKS*	Single Gang Plate Mortise Bi/LED with One SPDT Momentary Switch	2.75	4.50	212.50	203.00	196.00
6151MKSA*	Single Gang Plate Mortise Bi/LED with One SPDT Alternate - On/Off Switch	2.75	4.50	212.50	203.00	196.00
6151MKS2*	Single Gang Plate Mortise Bi/LED with One DPDT Momentary Switch	2.75	4.50	212.50	203.00	196.00
6151MKS2A*	Single Gang Plate Mortise Bi/LED with One DPDT Alternate - On/Off Switch	2.75	4.50	212.50	203.00	196.00
Twin Maximum						
8851MKS*	 Single Gang Plate Mortise Bi/LED with One SPDT Momentary Switch	2.75	4.50	212.50	203.00	196.00
8851MKSA*	 Single Gang Plate Mortise Bi/LED with One SPDT Alternate - On/Off Switch	2.75	4.50	212.50	203.00	196.00
8851MKS2*	 Single Gang Plate Mortise Bi/LED with One DPDT Momentary Switch	2.75	4.50	212.50	203.00	196.00
8851MKS2A*	 Single Gang Plate Mortise Bi/LED with One DPDT Alternate - On/Off Switch	2.75	4.50	212.50	203.00	196.00
Twin Maximum - Medium Security						
2851MKS*	Single Gang Plate Mortise Bi/LED with One SPDT Momentary Switch	2.75	4.50	212.50	203.00	196.00
2851MKSA*	Single Gang Plate Mortise Bi/LED with One SPDT Alternate - On/Off Switch	2.75	4.50	212.50	203.00	196.00
2851MKS2*	Single Gang Plate Mortise Bi/LED with One DPDT Momentary Switch	2.75	4.50	212.50	203.00	196.00
2851MKS2A*	Single Gang Plate Mortise Bi/LED with One DPDT Alternate - On/Off Switch	2.75	4.50	212.50	203.00	196.00

* Mortise Keyswitch assemblies can take up to two switches and are supplied with one switch. All switches are listed on page 108.

 – Twin Maximum available with CLIQ™ Technology, add \$500.00. Example: 8851 MKS x **CLIQ** x 626 x Sidebar x Comp

TWIN V-10, TWIN EXCLUSIVE, TWIN PRO, TWIN MAXIMUM, CLIQ

Auxiliary Locks

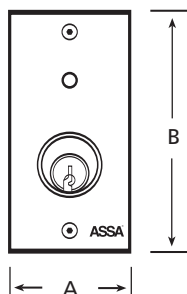

Mortise Keyswitches With Narrow Stile Plate

Model No.	Description	A	B	Comp	Sub	SNS
Twin V-10						
V6551MKS-N*	Narrow Stile Plate Mortise Bi/LED with One SPDT Momentary Switch	1.75	4.50	212.50	203.00	196.00
V6551MKSA-N*	Narrow Stile Plate Mortise Bi/LED with One SPDT Alternate - On/Off Switch	1.75	4.50	212.50	203.00	196.00
V6551MKS2-N*	Narrow Stile Plate Mortise Bi/LED with One DPDT Momentary Switch	1.75	4.50	212.50	203.00	196.00
V6551MKS2A-N*	Narrow Stile Plate Mortise Bi/LED with One DPDT Alternate - On/Off Switch	1.75	4.50	212.50	203.00	196.00
Twin Exclusive						
E6551MKS-N*	Narrow Stile Plate Mortise Bi/LED with One SPDT Momentary Switch	1.75	4.50	212.50	203.00	196.00
E6551MKSA-N*	Narrow Stile Plate Mortise Bi/LED with One SPDT Alternate - On/Off Switch	1.75	4.50	212.50	203.00	196.00
E6551MKS2-N*	Narrow Stile Plate Mortise Bi/LED with One DPDT Momentary Switch	1.75	4.50	212.50	203.00	196.00
E6551MKS2A-N*	Narrow Stile Plate Mortise Bi/LED with One DPDT Alternate - On/Off Switch	1.75	4.50	212.50	203.00	196.00
Twin 6000 Classic						
6551MKS-N*	Narrow Stile Plate Mortise Bi/LED with One SPDT Momentary Switch	1.75	4.50	212.50	203.00	196.00
6551MKSA-N*	Narrow Stile Plate Mortise Bi/LED with One SPDT Alternate - On/Off Switch	1.75	4.50	212.50	203.00	196.00
6551MKS2-N*	Narrow Stile Plate Mortise Bi/LED with One DPDT Momentary Switch	1.75	4.50	212.50	203.00	196.00
6551MKS2A-N*	Narrow Stile Plate Mortise Bi/LED with One DPDT Alternate - On/Off Switch	1.75	4.50	212.50	203.00	196.00
Twin Pro						
6151MKS-N*	Narrow Stile Plate Mortise Bi/LED with One SPDT Momentary Switch	1.75	4.50	212.50	203.00	196.00
6151MKSA-N*	Narrow Stile Plate Mortise Bi/LED with One SPDT Alternate - On/Off Switch	1.75	4.50	212.50	203.00	196.00
6151MKS2-N*	Narrow Stile Plate Mortise Bi/LED with One DPDT Momentary Switch	1.75	4.50	212.50	203.00	196.00
6151MKS2A-N*	Narrow Stile Plate Mortise Bi/LED with One DPDT Alternate - On/Off Switch	1.75	4.50	212.50	203.00	196.00
Twin Maximum						
8851MKS-N*	Narrow Stile Plate Mortise Bi/LED with One SPDT Momentary Switch	1.75	4.50	212.50	203.00	196.00
8851MKSA-N*	Narrow Stile Plate Mortise Bi/LED with One SPDT Alternate - On/Off Switch	1.75	4.50	212.50	203.00	196.00
8851MKS2-N*	Narrow Stile Plate Mortise Bi/LED with One DPDT Momentary Switch	1.75	4.50	212.50	203.00	196.00
8851MKS2A-N*	Narrow Stile Plate Mortise Bi/LED with One DPDT Alternate - On/Off Switch	1.75	4.50	212.50	203.00	196.00
Twin Maximum - Medium Security						
2851MKS-N*	Narrow Stile Plate Mortise Bi/LED with One SPDT Momentary Switch	1.75	4.50	212.50	203.00	196.00
2851MKSA-N*	Narrow Stile Plate Mortise Bi/LED with One SPDT Alternate - On/Off Switch	1.75	4.50	212.50	203.00	196.00
2851MKS2-N*	Narrow Stile Plate Mortise Bi/LED with One DPDT Momentary Switch	1.75	4.50	212.50	203.00	196.00
2851MKS2A-N*	Narrow Stile Plate Mortise Bi/LED with One DPDT Alternate - On/Off Switch	1.75	4.50	212.50	203.00	196.00

* Mortise Keyswitch assemblies can take up to two switches and are supplied with one switch. All switches are listed on page 108.

– Twin Maximum available with CLIQ™ Technology, add \$500.00. Example: 8851 MKS-N x **CLIQ** x 626 x Sidebar x Comp

Auxiliary Locks

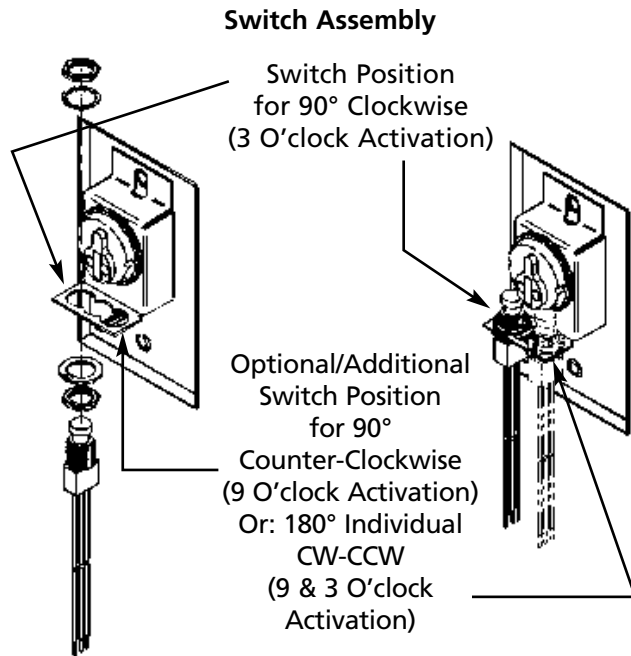

Switch
(Momentary/Alternate)

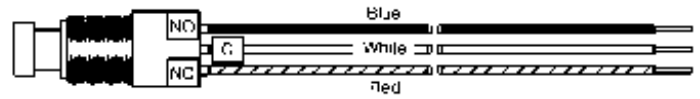

SPTD: 3-Wire (As Shown)
DPDT: 6-Wire (As Shown x 2 Pole Sets)

Optional Switches for Mortise Switch Plates

Model No.	Description	A	B	Comp	Sub	SNS
ASMKS	SPDT Momentary	NA	NA	43.00	NA	NA
ASMKSA	SPDT Alternate (ON/OFF)	NA	NA	43.00	NA	NA
ASMKS2	DPDT Momentary	NA	NA	71.50	NA	NA
ASMKS2A	DPDT Alternate (ON/OFF)	NA	NA	71.50	NA	NA

TWIN V-10, TWIN EXCLUSIVE, TWIN PRO, TWIN MAXIMUM, CLIQ

Auxiliary Locks

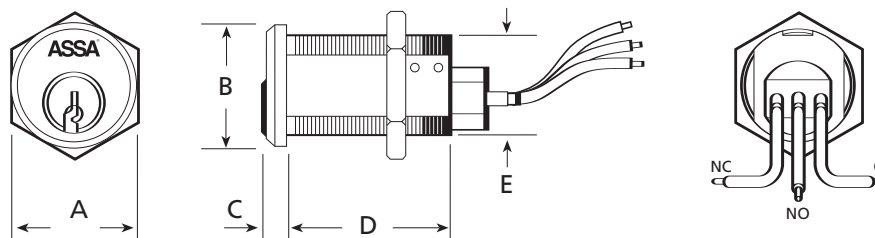

Keyswitches

Model No.	Description	A	B	C	D	E	Comp	Sub	SNS
Twin V-10									
V7700-LP	Keyswitch Switch Momentary	1.025	0.980	0.110	1.510	0.860	144.50	137.00	130.00
V7771-LP	Keyswitch Switch On/Off	1.025	0.980	0.110	1.510	0.860	144.50	137.00	130.00
Twin Exclusive									
E7700-LP	Keyswitch Switch Momentary	1.025	0.980	0.110	1.510	0.860	144.50	137.00	130.00
E7771-LP	Keyswitch Switch On/Off	1.025	0.980	0.110	1.510	0.860	144.50	137.00	130.00
Twin 6000 Classic									
7700-LP	Keyswitch Switch Momentary	1.025	0.980	0.110	1.510	0.860	164.00	155.00	146.00
7771-LP	Keyswitch Switch On/Off	1.025	0.980	0.110	1.510	0.860	164.00	155.00	146.00
Twin Pro									
6700-LP	Keyswitch Switch Momentary	1.025	0.980	0.110	1.510	0.860	144.50	137.00	130.00
6771-LP	Keyswitch Switch On/Off	1.025	0.980	0.110	1.510	0.860	144.50	137.00	130.00
Twin Maximum									
8870-LP	Keyswitch Switch Momentary	1.025	0.980	0.110	1.510	0.860	144.50	137.00	130.00
8871-LP	Keyswitch Switch On/Off	1.025	0.980	0.110	1.510	0.860	144.50	137.00	130.00

– Twin Maximum available with CLIQ™ Technology, add \$500.00. Example: 8870-LP x **CLIQ** x 626 x Sidebar x Comp

TWIN V-10, TWIN EXCLUSIVE, TWIN PRO, TWIN MAXIMUM, CLIQ

Auxiliary Locks

Cam Lock Catches

All measurements are in millimeters, to convert to inches multiply millimeters x .039370.

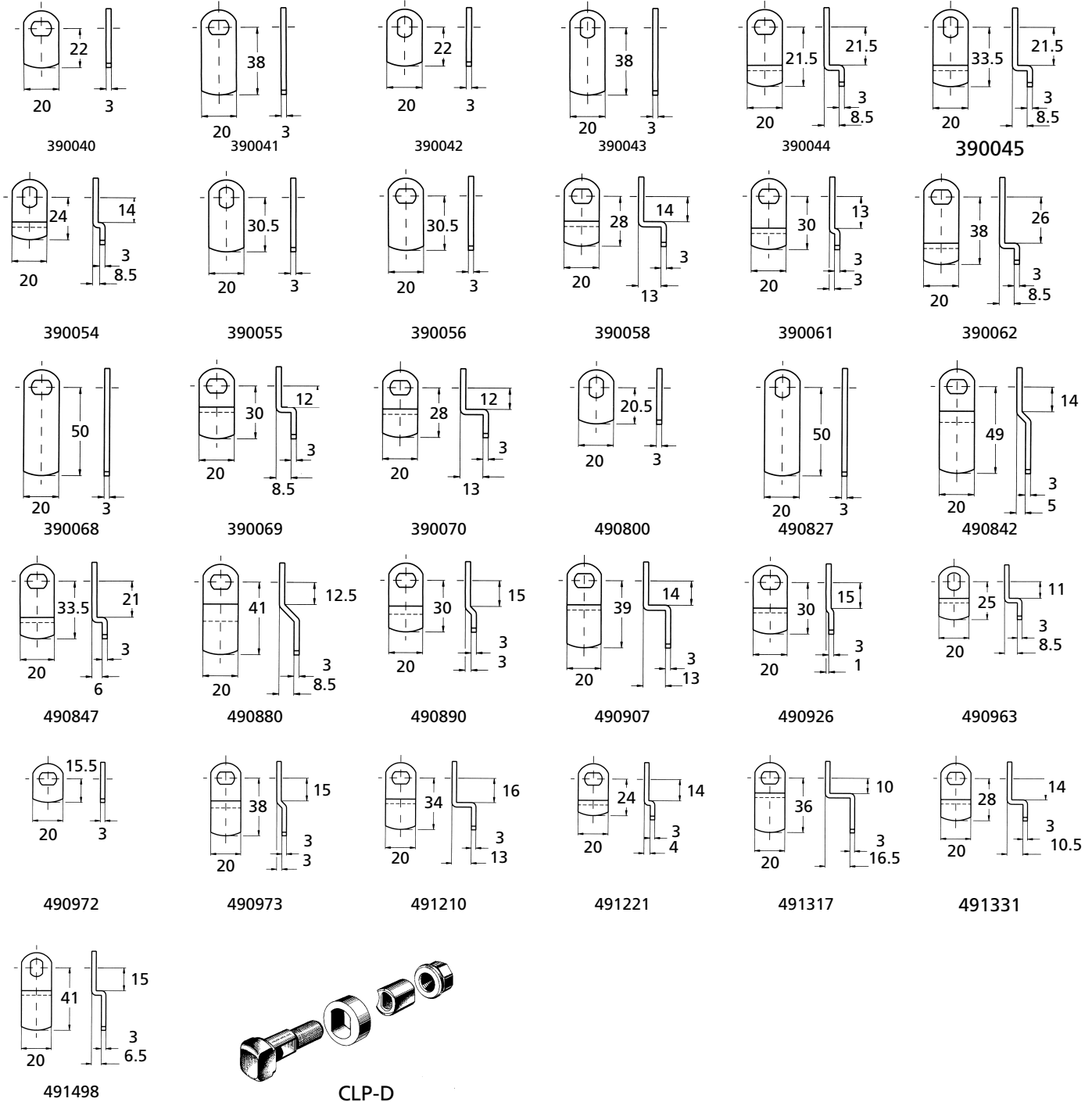

Cam Lock Accessories

Model No.	Description	Price
See Above	Cam Lock Catches	1.50
CLK-1	Cam Lock Catch Kit (Includes 2 ea. of 31 Cam Catches)	90.00
CLP-D	7/8" Double D Cam Lock/Switch Lock Punch	402.00

TWIN V-10, TWIN EXCLUSIVE, TWIN PRO, TWIN MAXIMUM, CLIQ

Auxiliary Locks

Cam Lock Accessories

All measurements are in millimeters, to convert to inches multiply millimeters x .039370.

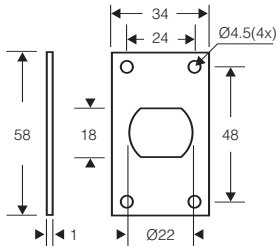

Fixing Plate 490825

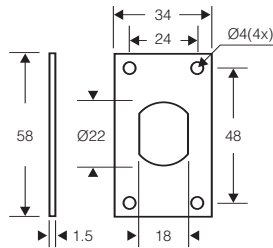

Fixing Plate 491449

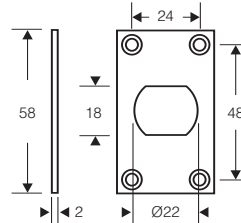

Front Plate 490821

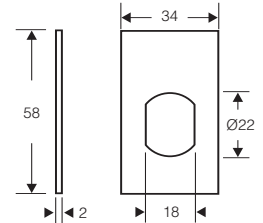

Front Plate 491450

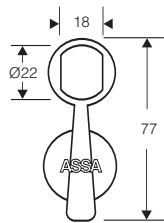

Dust Cap 391053

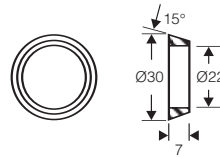

Cylinder Ring 490271

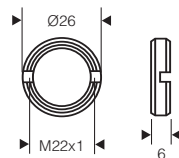

Housing Washer 490663

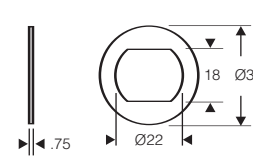

Front Plate 490657

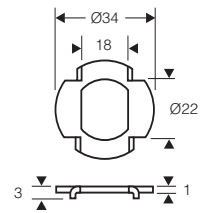

Nail Plate 491299

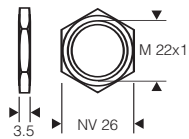

Housing Nut 490610

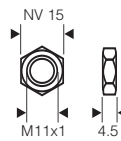

Nut 490583

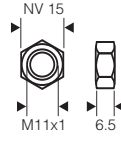

Nut 491439

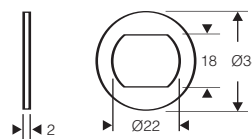

Front Plate 497008

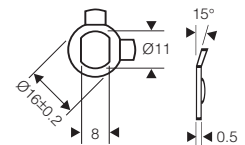

Lock Washer 490246

Cam Lock Accessories

Model No.	Description	Price
490271	Cam Lock cylinder ring	6.00
391053	Cam Lock dust cap	2.50
490825	Cam Lock fixing plate	2.00
491449	Cam Lock fixing plate	2.00
497008	Cam Lock front plate	3.50
490657	Cam Lock front plate	3.50
490821	Cam Lock front plate	3.50
491450	Cam Lock front plate	3.50
490246	Cam Lock washer	.75
491299	Cam Lock nail plate	1.00
490583	Cam Lock nut	1.50
491439	Cam Lock nut (m11x1)	1.50
490610	Cam Lock housing nut (m22x1)	2.00
490663	Cam Lock housing washer	4.00

TWIN V-10, TWIN EXCLUSIVE, TWIN PRO, TWIN MAXIMUM, CLIQ

Padlocks

ASSA manufactures high security padlocks in three classes, all of which can be integrated into any new or existing ASSA master key system. Our heavy duty padlocks are made from the highest quality materials and have withstood the most rigorous testing procedures. ASSA padlocks are used in a wide variety of applications including storage rooms, perimeter fences, and armories and feature the same level of patented key control as all ASSA high security cylinders.



Benefits:

- Sturdy design ensures maximum durability
- Class 2 available in key retaining and non-key retaining, extended shackle, and interchangeable core
- Shackle made of rust proof stainless steel
- Hockey Puck style shackleless design provides maximum protection against hacksaw and bolt cutter attacks
- Drain holes to prevent freezing
- No external screws or rivets
- Patented key control

Warranty:

- ASSA guarantees its products against defective workmanship or wear resulting from defects for life

Certification:

- All ASSA Padlock cylinders are U.L. 437 listed

Technical Information:

- Class 2 body extruded brass, stainless steel shackle, tensile strength 1.5 tons
- Class 3 body case hardened steel, stainless steel shackle, tensile strength 4.5 tons
- Class 2 convertible from key retaining to non-key retaining
- Hockey Puck style body can withstand up to 10,000 lbs of force from bolt cutters
- Stainless steel top pins
- Bottom pins and master pins are nickel silver

Padlocks Ordering Information

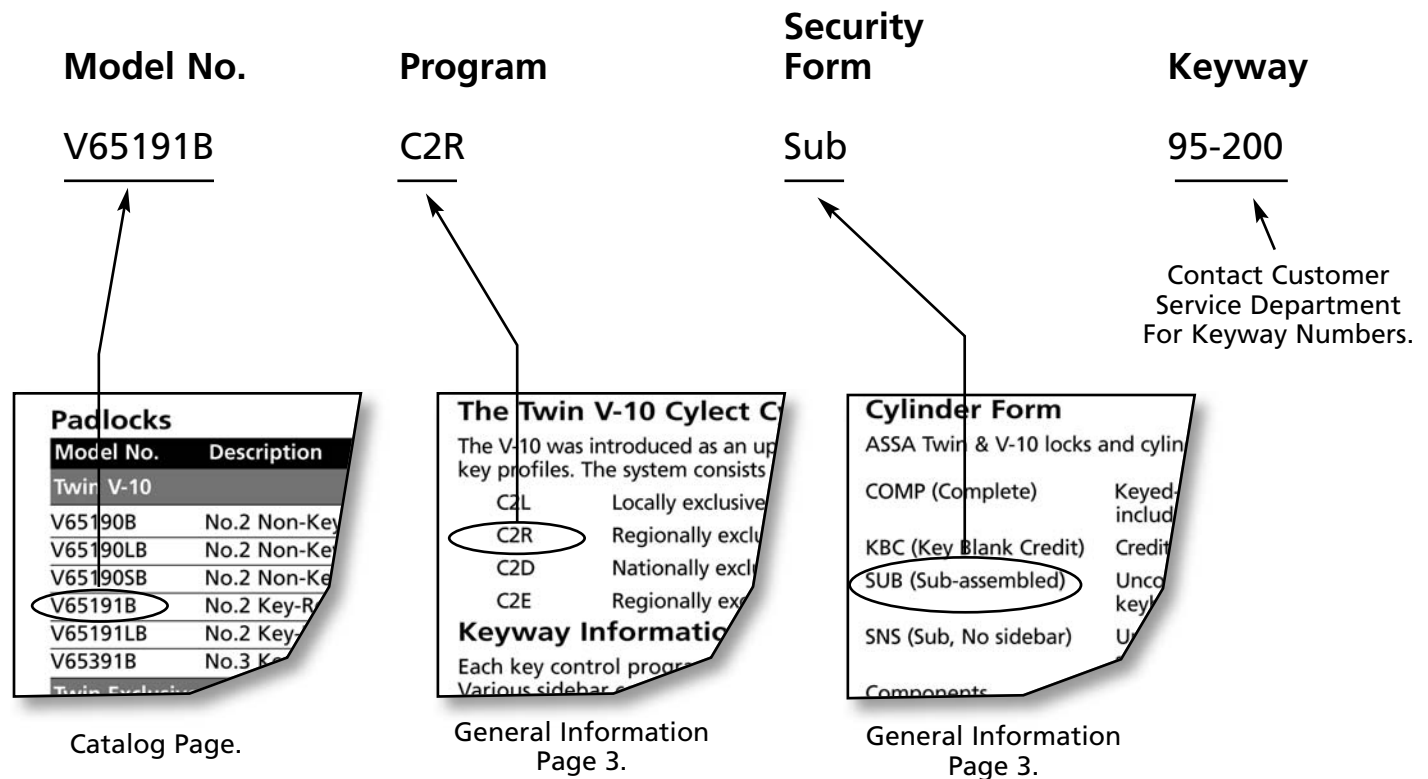

How To Order Padlocks:

Specify	Model No.	Security Program	Form	Keyway
Example:.....	V65191BC2RSUB95-100

TWIN V-10, TWIN EXCLUSIVE, TWIN PRO, TWIN MAXIMUM, CLIQ

Padlocks Exploded Views

#2 Padlock

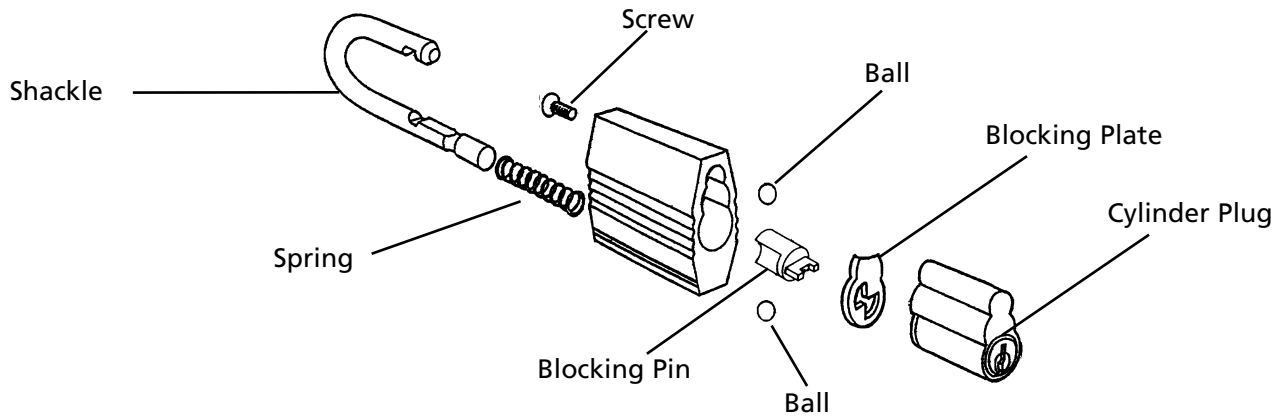

#2 Shrouded Padlock

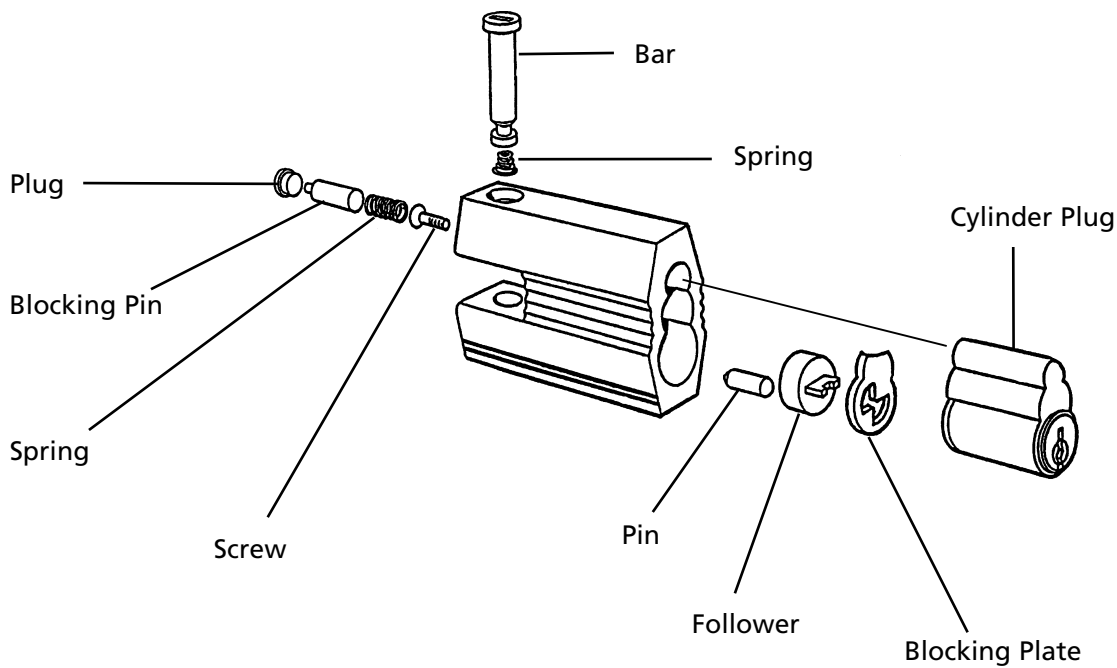

TWIN V-10, TWIN EXCLUSIVE, TWIN PRO, TWIN MAXIMUM, CLIQ

Padlocks Exploded Views

#3 Padlock

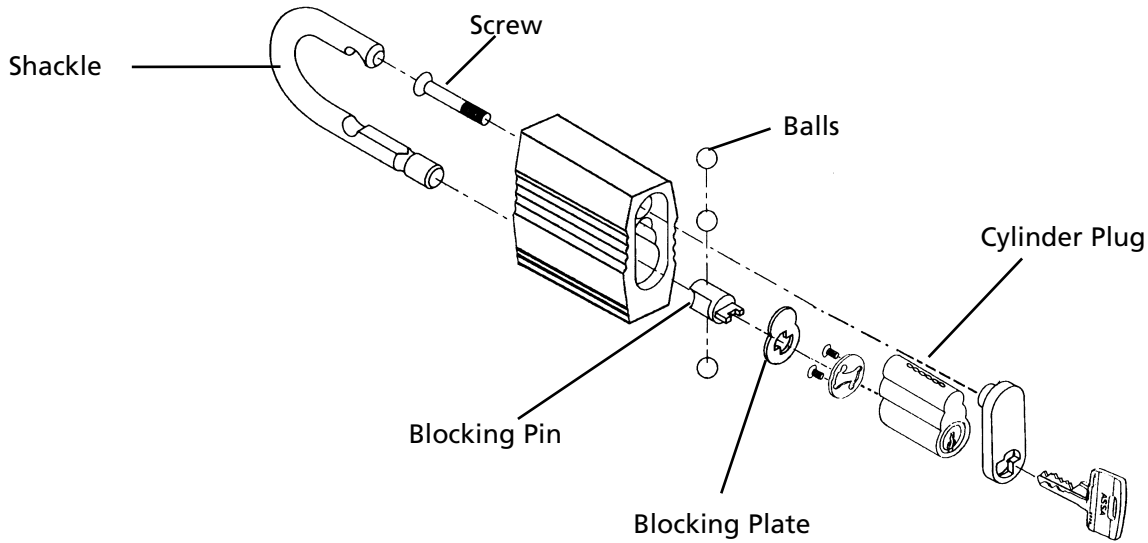

#4-5 Padlock

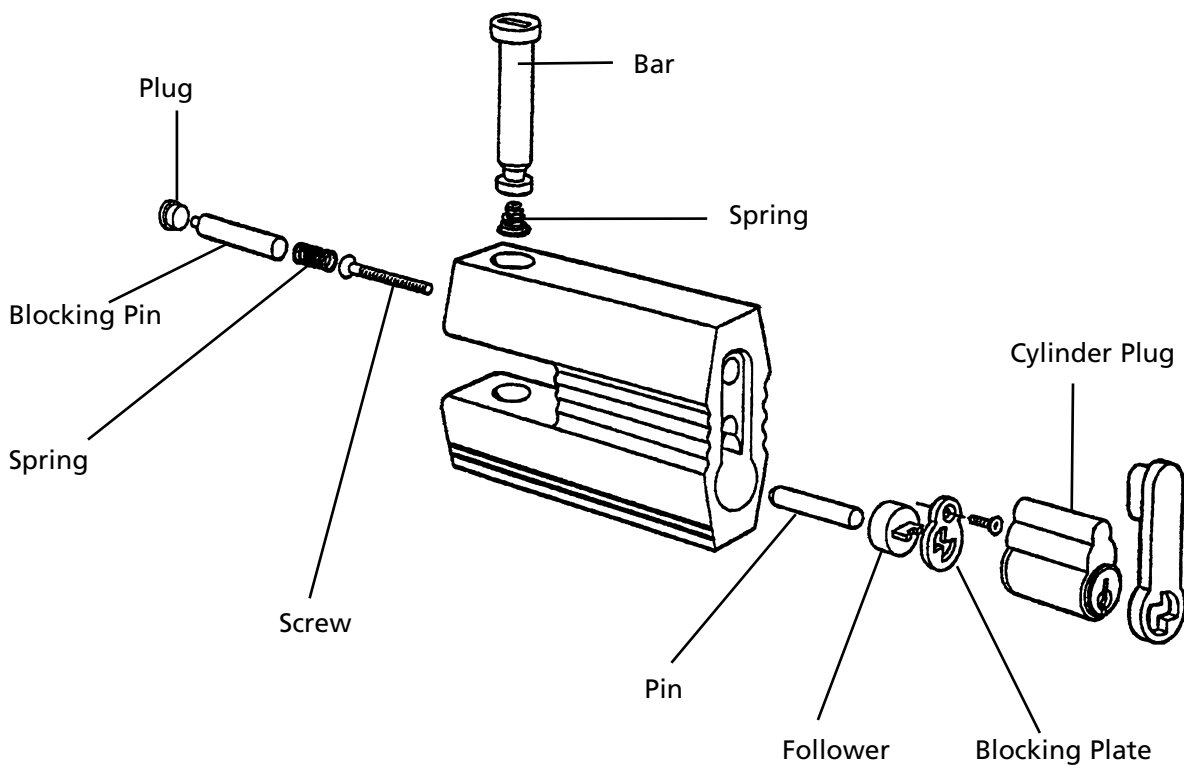

TWIN V-10, TWIN EXCLUSIVE, TWIN PRO, TWIN MAXIMUM, CLIQ

Padlocks

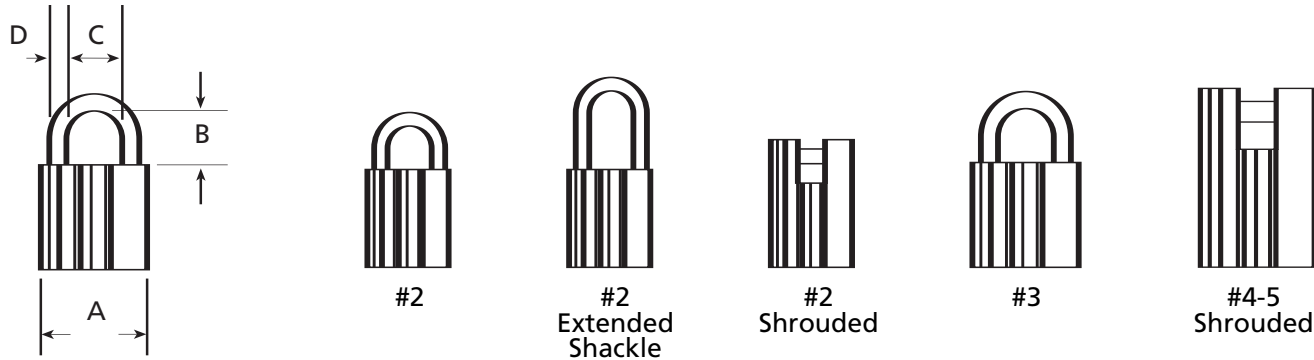

Padlocks

Model No.	Description	A	B	C	D	Comp	Sub	SNS
Twin V-10								
V65190B	No.2 Non-Key-Retaining	1.900	1.100	0.940	0.315	88.00	80.50	73.50
V65190LB	No.2 Non-Key-Retaining Ext. Shackle	1.900	2.035	0.940	0.315	94.00	86.50	79.50
V65190SB	No.2 Non-Key-Ret. w/Shrouded Shackle	1.900	0.535	0.475	0.315	102.00	95.00	88.00
V65191B	No.2 Key-Retaining	1.900	1.100	0.940	0.315	88.00	80.50	73.50
V65191LB	No.2 Key-Retaining Ext. Shackle	1.900	2.035	0.940	0.315	94.00	86.50	79.50
V65391B	No.3 Key-Retaining	2.450	1.235	1.295	0.395	162.00	154.50	147.50
V65391SB	No.3 Key Ret. w/Shrouded Shackle	2.450	0.710	0.590	0.395	169.00	161.50	154.50
V65591SB	No.5 Key Ret. w/Shrouded Shackle	3.150	0.985	0.830	0.550	283.00	275.50	268.50
Twin Exclusive								
E65190B	No.2 Non-Key-Retaining	1.900	1.100	0.940	0.315	88.00	80.50	73.50
E65190LB	No.2 Non-Key-Retaining Ext. Shackle	1.900	2.035	0.940	0.315	94.00	86.50	79.50
E65190SB	No.2 Non-Key-Ret. w/Shrouded Shackle	1.900	0.535	0.475	0.315	102.00	95.00	88.00
E65191B	No.2 Key-Retaining	1.900	1.100	0.940	0.315	88.00	80.50	73.50
E65191LB	No.2 Key-Retaining Ext. Shackle	1.900	2.035	0.940	0.315	94.00	86.50	79.50
E65391B	No.3 Key-Retaining	2.450	1.235	1.295	0.395	162.00	154.50	147.50
E65391SB	No.3 Key Ret. w/Shrouded Shackle	2.450	0.710	0.590	0.395	169.00	161.50	154.50
E65591SB	No.5 Key Ret. w/Shrouded Shackle	3.150	0.985	0.830	0.550	283.00	275.50	268.50
Twin 6000 Classic								
65190B	No.2 Non-Key-Retaining	1.900	1.100	0.940	0.315	103.00	94.00	85.00
65190LB	No.2 Non-Key-Retaining Ext. Shackle	1.900	2.035	0.940	0.315	110.00	101.00	92.00
65190SB	No.2 Non-Key-Ret. w/Shrouded Shackle	1.900	0.535	0.475	0.315	120.00	111.00	102.00
65191B	No.2 Key-Retaining	1.900	1.100	0.940	0.315	103.00	94.00	85.00
65191LB	No.2 Key-Retaining Ext. Shackle	1.900	2.035	0.940	0.315	110.00	101.00	92.00
65391B	No.3 Key-Retaining	2.450	1.235	1.295	0.395	184.00	175.00	166.00
65391SB	No.3 Key Ret. w/Shrouded Shackle	2.450	0.710	0.590	0.395	192.50	185.00	178.00
65591SB	No.5 Key Ret. w/Shrouded Shackle	3.150	0.985	0.830	0.550	322.00	314.50	307.50

TWIN V-10, TWIN EXCLUSIVE, TWIN PRO, TWIN MAXIMUM, CLIQ

Padlocks

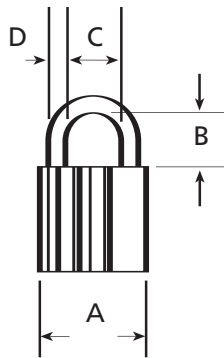

#2



#2
Extended
Shackle



#2
Shrouded



#3

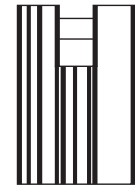

#4-5
Shrouded

Padlocks

Model No.	Description	A	B	C	D	Comp	Sub	SNS
Twin Pro								
61190B	No.2 Non-Key-Retaining	1.900	1.100	0.940	0.315	88.00	80.50	73.50
61190LB	No.2 Non-Key-Retaining Ext. Shackle	1.900	2.035	0.940	0.315	94.00	86.50	79.50
61190SB	No.2 Non-Key-Ret. w/Shrouded Shackle	1.900	0.535	0.475	0.315	102.00	95.00	88.00
61191B	No.2 Key-Retaining	1.900	1.100	0.940	0.315	88.00	80.50	73.50
61191LB	No.2 Key-Retaining Ext. Shackle	1.900	2.035	0.940	0.315	94.00	86.50	79.50
61391B	No.3 Key-Retaining	2.450	1.235	1.295	0.395	162.00	154.50	147.50
61391SB	No.3 Key Ret. w/Shrouded Shackle	2.450	0.710	0.590	0.395	169.00	161.50	154.50
61591SB	No.5 Key Ret. w/Shrouded Shackle	3.150	0.985	0.830	0.550	283.00	275.50	268.50
Twin Maximum								
88190B	No.2 Non-Key-Retaining	1.900	1.100	0.940	0.315	88.00	80.50	73.50
88190LB	No.2 Non-Key-Retaining Ext. Shackle	1.900	2.035	0.940	0.315	94.00	86.50	79.50
88190SB	No.2 Non-Key-Ret. w/Shrouded Shackle	1.900	0.535	0.475	0.315	102.00	95.00	88.00
88191B	No.2 Key-Retaining	1.900	1.100	0.940	0.315	88.00	80.50	73.50
88191LB	No.2 Key-Retaining Ext. Shackle	1.900	2.035	0.940	0.315	94.00	86.50	79.50
88391B	No.3 Key-Retaining	2.450	1.235	1.295	0.395	162.00	154.50	147.50
88391SB	No.3 Key Ret. w/Shrouded Shackle	2.450	0.710	0.590	0.395	169.00	161.50	154.50
88591SB	No.5 Key Ret. w/Shrouded Shackle	3.150	0.985	0.830	0.550	283.00	275.50	268.50
600 Series Classic								
6190B	No.2 Non-Key-Retaining	1.900	1.100	0.940	0.315	103.00	94.00	—
6190LB	No.2 Non-Key-Retaining Ext. Shackle	1.900	2.035	0.940	0.315	110.00	101.00	—
6190SB	No.2 Non-Key-Ret. w/Shrouded Shackle	1.900	0.535	0.475	0.315	120.00	111.00	—
6191B	No.2 Key-Retaining	1.900	1.100	0.940	0.315	103.00	94.00	—
6191LB	No.2 Key-Retaining Ext. Shackle	1.900	2.035	0.940	0.315	110.00	101.00	—
6391B	No.3 Key-Retaining	2.450	1.235	1.295	0.395	184.00	175.00	—

– Twin Maximum available with CLIQ™ Technology, add \$500.00. Example: 88190B x **CLIQ** x Comp

TWIN V-10, TWIN EXCLUSIVE, TWIN PRO, TWIN MAXIMUM, CLIQ

Padlocks

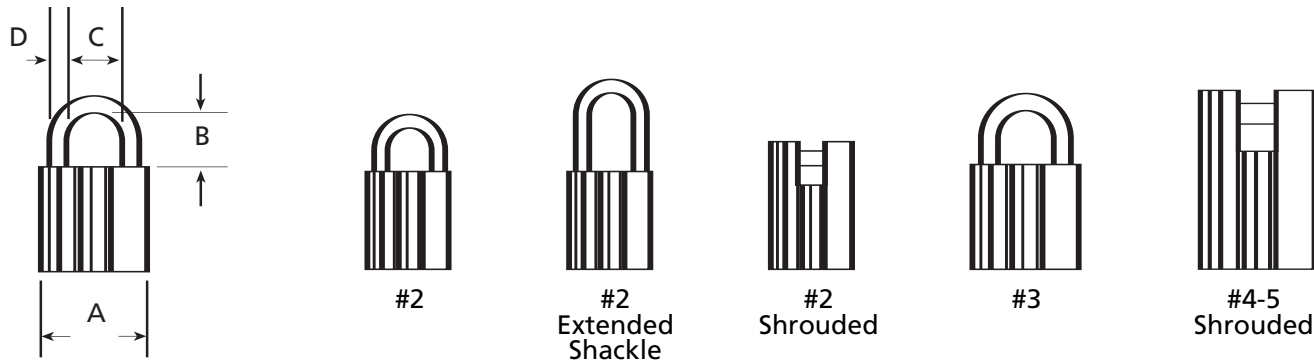

Interchangeable Core Padlocks

Model No.	Description	A	B	C	D	Comp	Sub	SNS
Twin V-10								
V65191BIC	No.2 Key-Retaining IC	1.900	1.100	0.940	0.315	110.00	102.50	95.50
V65191LBIC	No.2 Key-Retaining Ext. Shackle IC	1.900	2.035	0.940	0.315	120.50	113.00	106.00
Twin Exclusive								
E65191BIC	No.2 Key-Retaining IC	1.900	1.100	0.940	0.315	110.00	102.50	95.50
E65191LBIC	No.2 Key-Retaining Ext. Shackle IC	1.900	2.035	0.940	0.315	120.50	113.00	106.00
Twin 6000 Classic								
65191BIC	No.2 Key-Retaining IC	1.900	1.100	0.940	0.315	129.00	120.00	111.00
65191LBIC	No.2 Key-Retaining Ext. Shackle IC	1.900	2.035	0.940	0.315	142.00	132.00	124.00
Twin Pro								
61191BIC	No.2 Key-Retaining, IC	1.900	1.100	0.940	0.315	110.00	102.50	95.50
61191LBIC	No.2 Key-Retaining Ext. Shackle, IC	1.900	2.035	0.940	0.315	120.50	113.00	106.00
Twin Maximum								
88191BIC	No.2 Key-Retaining, IC	1.900	1.100	0.940	0.315	110.00	102.50	95.50
88191LBIC	No.2 Key-Retaining Ext. Shackle, IC	1.900	2.035	0.940	0.315	120.50	113.00	106.00

Padlock Cylinders Only

Model No.	Description	Comp	Sub	SNS
Twin V-10				
V65911	Padlock Cylinder No. 2, 3, 4-5	59.00	51.50	44.50
Twin Exclusive				
E65911	Padlock Cylinder No. 2, 3, 4-5	59.00	51.50	44.50
Twin 6000 Classic				
65911	Padlock Cylinder No. 2, 3, 4-5	66.00	57.00	48.00
Twin Pro				
61911	Padlock Cylinder No. 2, 3, 4-5	59.00	51.50	44.50
Twin Maximum				
88911	Padlock Cylinder No. 2, 3, 4-5	59.00	51.50	44.50
600 Series Classic				
6911	Padlock Cylinder No. 2, 3, 4-5	66.00	57.00	—

– Twin Maximum available with CLIQ™ Technology, add \$500.00. Example: 88911 x **CLIQ** x Comp

TWIN V-10, TWIN EXCLUSIVE, TWIN PRO, TWIN MAXIMUM, CLIQ

Padlocks

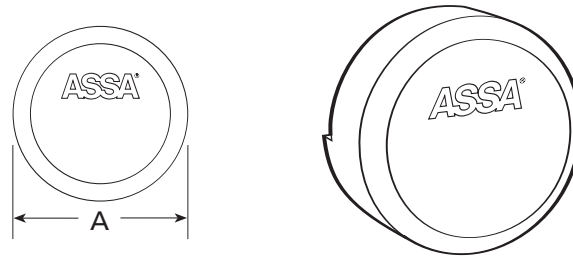

“Hockey Puck” Shackle Less Padlock

Model No.	Description	A	Comp	Sub	SNS
Twin V-10					
V6540	Hockey Puck Style Padlock	2.875	89.50	81.00	74.50
Twin Exclusive					
E6540	Hockey Puck Style Padlock	2.875	89.50	81.00	74.50
Twin Pro					
6140	Hockey Puck Style Padlock	2.875	89.50	81.00	74.50
Twin Maximum					
8840	Hockey Puck Style Padlock	2.875	89.50	81.00	74.50

“Hockey Puck” Cylinders Only

Model No.	Description	Comp	Sub	SNS
Twin V-10				
V65411	Hockey Puck Cylinder	56.50	49.00	42.00
Twin Exclusive				
E65411	Hockey Puck Cylinder	56.50	49.00	42.00
Twin Pro				
61411	Hockey Puck Cylinder	56.50	49.00	42.00
Twin Maximum				
88411	Hockey Puck Cylinder	56.50	49.00	42.00

– Twin Maximum available with CLIQ™ Technology, add \$500.00. Example: **88911** x **CLIQ** x **Comp**

TWIN V-10, TWIN EXCLUSIVE, TWIN PRO, TWIN MAXIMUM, CLIQ

Padlocks Component Parts

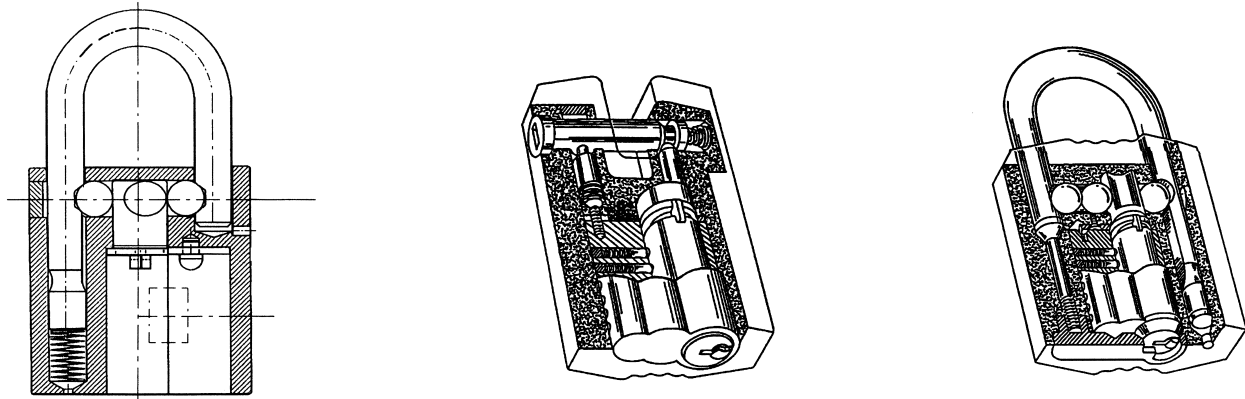

Padlocks Parts

Model No.	Description	Price
806898	No.2 Regular Shackle	21.00
807217	No.2 Extended Shackle	23.00
P250517	No.2 Shackle Spring	.75
806910	No.3 Padlock Shackle	25.00
809387	No.2 Key-Retaining Blocking pin	3.50
809388	No.2 Non-Key-Retaining Blocking Pin/Spring/Tailpiece	24.00
P793810	No.2 Tailpiece Cam Screws	.75
867046	No.2 Tailpiece Washer	3.50
P857300	No.2 Plate & No. 3 Plate	.50
803607	No.2 Locking Balls	.50
P793110	No.2 Cylinder Retaining Screw	.75
806913	No.3 Cylinder Retaining Screw	4.50
803575	No.3 Locking Ball Bearings	1.25
806911	No.3 Blocking Pin	17.50
353969	Twin V-10 Padlock Cylinder Plug	26.00
367018	Twin Exclusive/6000 Classic Padlock Cylinder Plug (Specify Profile)	26.00

Profile Cylinders

ASSA manufactures a wide variety of high security European style profile cylinders including the Scandinavian oval cylinder used in ASSA modular locksets, the Euro Din cylinder, and the British Oval cylinder.

Available for different door thicknesses and featuring an adjustable cam actuator, ASSA profile cylinders can be used with many types of imported lockset and specialty hardware.

All profile cylinders are protected with ASSA's patented key control and can be keyed into any new or existing ASSA key system.



Benefits:

- Retrofits wide variety of European applications
- Adjustable cam actuator
- Two independent locking mechanisms to ensure security and optimum pick resistance
- Inactive "false" grooves on side pins designed to catch picking tools
- Patented key control

Warranty:

- ASSA guarantees its products against defective workmanship or wear resulting from defects for life

Certification:

- All ASSA Profile Cylinders are U.L. 437 listed

Technical Information:

- Euro Din and British Oval available for 3 different door thicknesses
- Cylinder housing and plug made of high quality brass
- Stainless steel top pins
- Bottom pins and master pins are nickel silver

Finishes:

<u>BHMA Symbol</u>	<u>U.S. Symbol</u>	<u>Euro Finishes</u>	<u>Description</u>
625	US 26	11	Bright Chrome
626	US 26D	13	Satin Chrome
605	US 3	20	Bright Brass
606	US 4	23	Satin Brass
612	US 10	33	Satin Bronze
624	US 10B	46	Dark Oxidized Bronze

TWIN V-10, TWIN EXCLUSIVE, TWIN PRO, TWIN MAXIMUM, CLIQ

Profile Cylinders Ordering Information

Model No. V6531 Finish 605 Form COMP Door Thickness 61 Cam Position 1 Keyway 95-200

British Oval Profile Cylinders

Model No.	Description
Twin V-10	
V6531	61mm Large
V6531	71mm Large
V6531	81mm Large
V6534	61mm Sm
V6534	71mm Sm
V6534	81mm
V6532	61mm

Catalog Page.

FINISHES
Standard finishes are shown below

ASSA BHMA Symbol
625
626
605
606
609
624
612

General Information Page 4.

Cylinder Form
ASSA Twin & V-10 locks and cylinders

COMP (Complete)	Keyed-included
KBC (Key Blank Credit)	Credit
SUB (Sub-assembled)	Unkeyed
SNS (Sub, No sidebar)	Unkeyed

General Information Page 3.

Contact Customer Service Department For Keyway Numbers.

How To Order Profile Cylinders:

Specify Model No. Finish Form Door Thickness Cam Position Keyway

Example:V6531605.....Comp61195-200

How To Determine Cam Position:

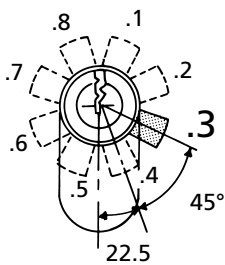

V6531/V6534

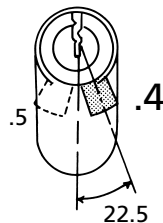

V6522/V6532

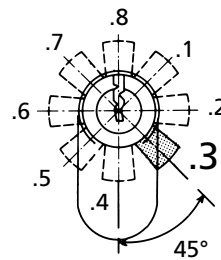

V6523/V6533

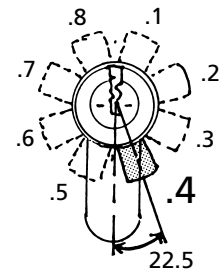

V6521/V6524

Twin Pro available through special order.

British Oval and Euro Din Cylinders are available in 626 and 605 finish only.

TWIN V-10, TWIN EXCLUSIVE, TWIN PRO, TWIN MAXIMUM, CLIQ

Profile Cylinders Exploded View

6531 – Large Thumbturn Model

6534 – Small Thumbturn Model

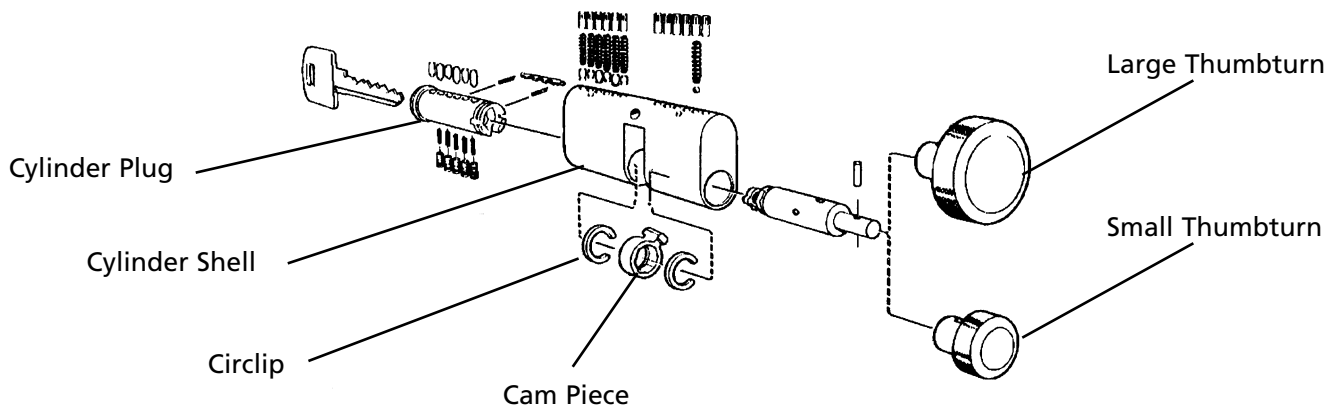

6532 – Double Cylinder Model

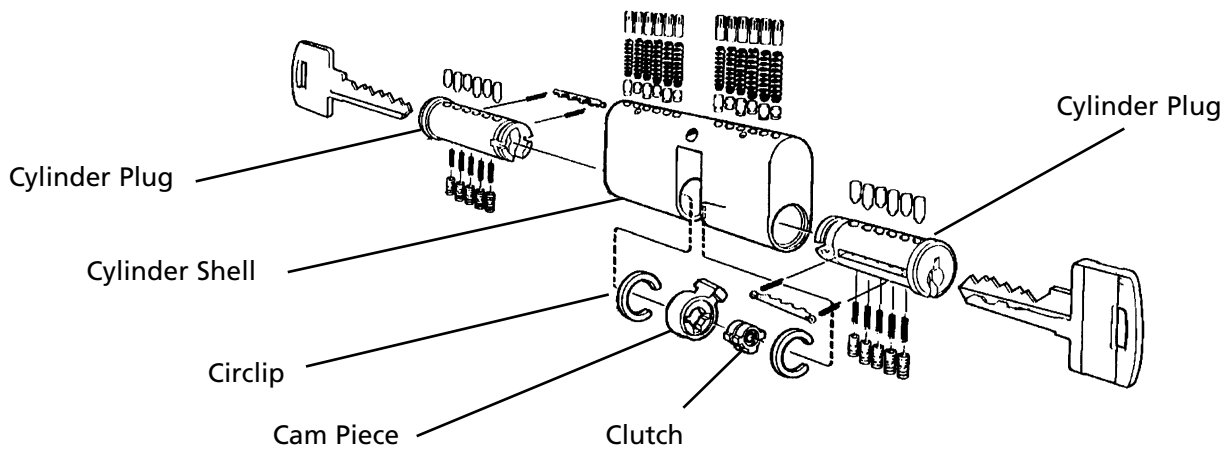

TWIN V-10, TWIN EXCLUSIVE, TWIN PRO, TWIN MAXIMUM, CLIQ

Profile Cylinders Exploded View

6533 – Single Cylinder Model

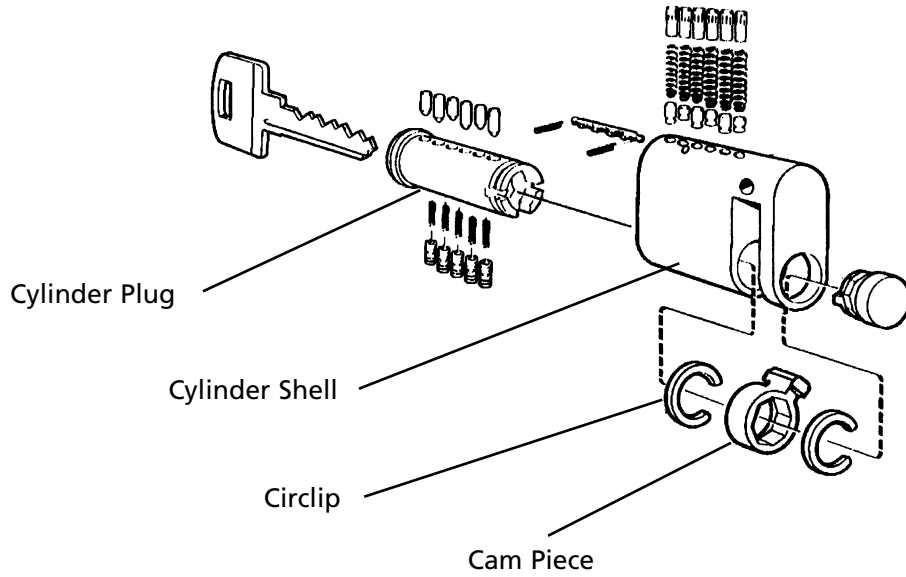

Oval Cylinders

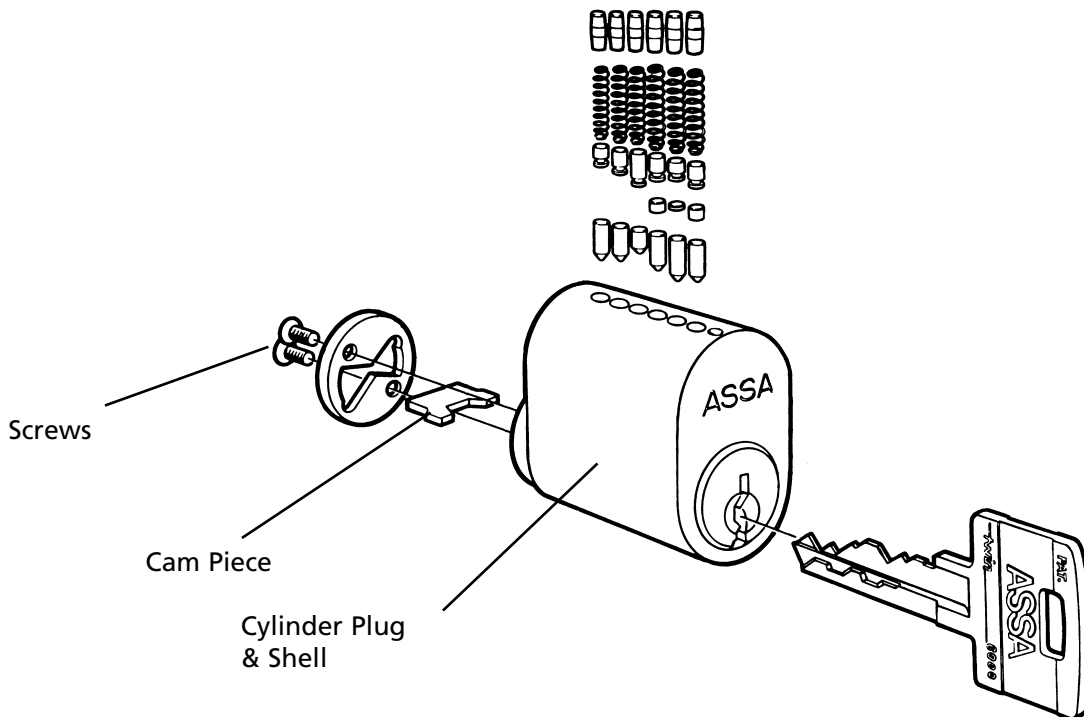

TWIN V-10, TWIN EXCLUSIVE, TWIN PRO, TWIN MAXIMUM, CLIQ

Profile Cylinders

Profile Cylinder Key:

- TL – Total Length
- A – Exterior Length
- B – Interior Length
- C – Knob Length

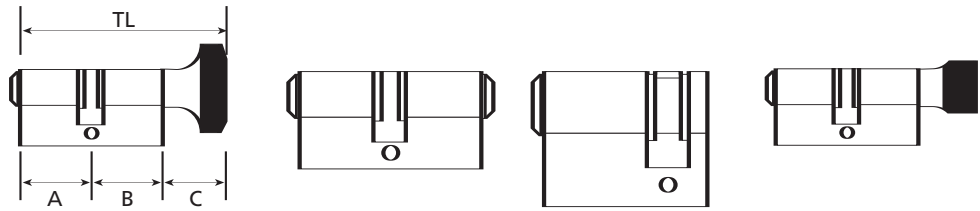

British Oval Profile Cylinders

Model No.	Description	TL	A	B	C	Comp	Sub	SNS
Twin V-10								
V6531	61mm Large Single Cyl.	3.481	1.209	1.209	1.063	112.00	105.00	100.00
V6531	71mm Large Single Cyl.	3.875	1.406	1.406	1.063	112.00	105.00	100.00
V6531	81mm Large Single Cyl.	4.269	1.603	1.603	1.063	112.00	105.00	100.00
V6534	61mm Small Single Cyl.	3.481	1.209	1.209	1.063	100.00	93.00	88.00
V6534	71mm Small Single Cyl.	3.875	1.406	1.406	1.063	100.00	93.00	88.00
V6534	81mm Small Single Cyl.	4.269	1.603	1.603	1.063	100.00	93.00	88.00
V6532	61mm Double Cylinder	2.418	1.209	1.209	N/A	124.50	117.00	112.50
V6532	71mm Double Cylinder	2.812	1.406	1.406	N/A	124.50	117.00	112.50
V6532	81mm Double Cylinder	3.206	1.603	1.603	N/A	124.50	117.00	112.50
V6533	40.5mm Single Cylinder	1.595	1.209	0.398	N/A	100.00	93.00	88.00
V6533	45.5mm Single Cylinder	1.794	1.406	0.398	N/A	100.00	93.00	88.00
V6533	50.5mm Single Cylinder	1.990	1.603	0.398	N/A	100.00	93.00	88.00
Twin Exclusive								
E6531	61mm Large Single Cyl.	3.481	1.209	1.209	1.063	112.00	105.00	100.00
E6531	71mm Large Single Cyl.	3.875	1.406	1.406	1.063	112.00	105.00	100.00
E6531	81mm Large Single Cyl.	4.269	1.603	1.603	1.063	112.00	105.00	100.00
E6534	61mm Small Single Cyl.	3.481	1.209	1.209	1.063	100.00	93.00	88.00
E6534	71mm Small Single Cyl.	3.875	1.406	1.406	1.063	100.00	93.00	88.00
E6534	81mm Small Single Cyl.	4.269	1.603	1.603	1.063	100.00	93.00	88.00
E6532	61mm Double Cylinder	2.418	1.209	1.209	N/A	124.50	117.00	112.50
E6532	71mm Double Cylinder	2.812	1.406	1.406	N/A	124.50	117.00	112.50
E6532	81mm Double Cylinder	3.206	1.603	1.603	N/A	124.50	117.00	112.50
E6533	40.5mm Single Cylinder	1.595	1.209	0.398	N/A	100.00	93.00	88.00
E6533	45.5mm Single Cylinder	1.794	1.406	0.398	N/A	100.00	93.00	88.00
E6533	50.5mm Single Cylinder	1.990	1.603	0.398	N/A	100.00	93.00	88.00

TWIN V-10, TWIN EXCLUSIVE, TWIN PRO, TWIN MAXIMUM, CLIQ

Profile Cylinders

Profile Cylinder Key:

- TL – Total Length
- A – Exterior Length
- B – Interior Length
- C – Knob Length

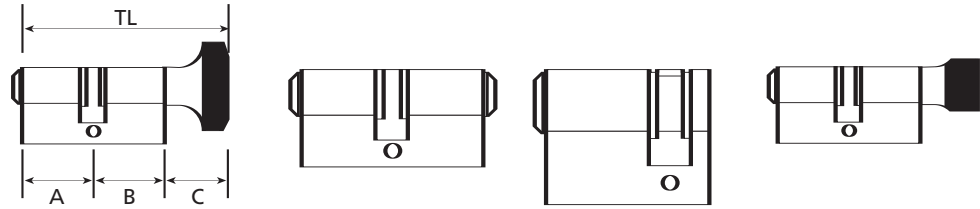

British Oval Profile Cylinders

Model No.	Description	TL	A	B	C	Comp	Sub	SNS
Twin 6000 Classic								
6531	61mm Large Single Cyl.	3.481	1.209	1.209	1.063	128.00	119.00	113.00
6531	71mm Large Single Cyl.	3.875	1.406	1.406	1.063	128.00	119.00	113.00
6531	81mm Large Single Cyl.	4.269	1.603	1.603	1.063	128.00	119.00	113.00
6534	61mm Small Single Cyl.	3.481	1.209	1.209	1.063	112.50	104.50	98.50
6534	71mm Small Single Cyl.	3.875	1.406	1.406	1.063	112.50	104.50	98.50
6534	81mm Small Single Cyl.	4.269	1.603	1.603	1.063	112.50	104.50	98.50
6532	61mm Double Cylinder	2.418	1.209	1.209	N/A	142.00	133.00	127.00
6532	71mm Double Cylinder	2.812	1.406	1.406	N/A	142.00	133.00	127.00
6532	81mm Double Cylinder	3.206	1.603	1.603	N/A	142.00	133.00	127.00
6533	40.5mm Single Cylinder	1.595	1.209	0.398	N/A	112.50	104.50	95.50
6533	45.5mm Single Cylinder	1.794	1.406	0.398	N/A	112.50	104.50	95.50
6533	50.5mm Single Cylinder	1.990	1.603	0.398	N/A	112.50	104.50	95.50
600 Series Classic								
631	61mm Large Single Cyl.	3.481	1.209	1.209	1.063	122.00	113.00	—
631	71mm Large Single Cyl.	3.875	1.406	1.406	1.063	122.00	113.00	—
631	81mm Large Single Cyl.	4.269	1.603	1.603	1.063	122.00	113.00	—
634	61mm Small Single Cyl.	3.481	1.209	1.209	1.063	107.00	99.00	—
634	71mm Small Single Cyl.	3.875	1.406	1.406	1.063	107.00	99.00	—
634	81mm Small Single Cyl.	4.269	1.603	1.603	1.063	107.00	99.00	—
632	61mm Double Cylinder	2.418	1.209	1.209	N/A	135.00	126.00	—
632	71mm Double Cylinder	2.812	1.406	1.406	N/A	135.00	126.00	—
632	81mm Double Cylinder	3.206	1.603	1.603	N/A	135.00	126.00	—
633	40.5mm Single Cylinder	1.595	1.209	0.398	N/A	107.00	99.00	—
633	45.5mm Single Cylinder	1.794	1.406	0.398	N/A	107.00	99.00	—
633	50.5mm Single Cylinder	1.990	1.603	0.398	N/A	107.00	99.00	—

TWIN V-10, TWIN EXCLUSIVE, TWIN PRO, TWIN MAXIMUM, CLIQ

Profile Cylinders

Profile Cylinder Key:

- TL – Total Length
- A – Exterior Length
- B – Interior Length
- C – Knob Length

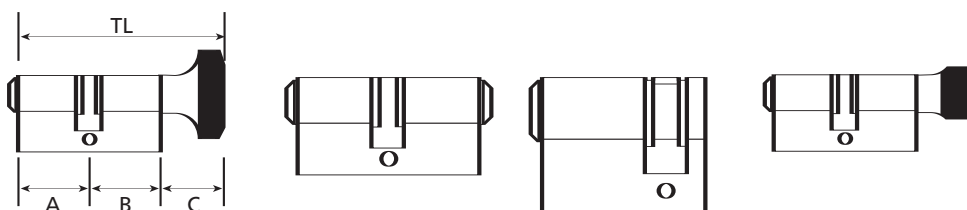

Din Euro Profile Cylinders

Model No.	Description	TL	A	B	C	Comp	Sub	SNS
Twin V-10								
V6521	61mm Large Single Cyl.	3.470	1.210	1.210	1.050	98.50	89.00	84.00
V6521	71mm Large Single Cyl.	3.864	1.407	1.407	1.050	98.50	89.00	84.00
V6521	81mm Large Single Cyl.	4.258	1.604	1.604	1.050	98.50	89.00	84.00
V6524	61mm Small Single Cyl.	3.480	1.210	1.210	1.065	97.50	88.00	83.00
V6524	71mm Small Single Cyl.	3.864	1.407	1.407	1.065	97.50	88.00	83.00
V6524	81mm Small Single Cyl.	4.258	1.604	1.604	1.065	97.50	88.00	83.00
V6522	61mm Double Cylinder	4.420	1.210	1.210	N/A	107.00	98.00	92.50
V6522	71mm Double Cylinder	2.814	1.407	1.407	N/A	107.00	98.00	92.50
V6522	81mm Double Cylinder	3.208	1.604	1.604	N/A	107.00	98.00	92.50
V6523	40.5mm Single Cylinder	1.571	1.203	0.368	N/A	68.00	59.00	54.00
V6523	45.5mm Single Cylinder	1.768	1.400	0.368	N/A	68.00	59.00	54.00
V6523	50.5mm Single Cylinder	1.965	1.597	0.368	N/A	68.00	59.00	54.00
Twin Exclusive								
E6521	61mm Large Single Cyl.	3.470	1.210	1.210	1.050	98.50	89.00	84.00
E6521	71mm Large Single Cyl.	3.864	1.407	1.407	1.050	98.50	89.00	84.00
E6521	81mm Large Single Cyl.	4.258	1.604	1.604	1.050	98.50	89.00	84.00
E6524	61mm Small Single Cyl.	3.480	1.210	1.210	1.065	97.50	88.00	83.00
E6524	71mm Small Single Cyl.	3.864	1.407	1.407	1.065	97.50	88.00	83.00
E6524	81mm Small Single Cyl.	4.258	1.604	1.604	1.065	97.50	88.00	83.00
E6522	61mm Double Cylinder	4.420	1.210	1.210	N/A	107.00	98.00	92.50
E6522	71mm Double Cylinder	2.814	1.407	1.407	N/A	107.00	98.00	92.50
E6522	81mm Double Cylinder	3.208	1.604	1.604	N/A	107.00	98.00	92.50
E6523	40.5mm Single Cylinder	1.571	1.203	0.368	N/A	68.00	59.00	54.00
E6523	45.5mm Single Cylinder	1.768	1.400	0.368	N/A	68.00	59.00	54.00
E6523	50.5mm Single Cylinder	1.965	1.597	0.368	N/A	68.00	59.00	54.00

TWIN V-10, TWIN EXCLUSIVE, TWIN PRO, TWIN MAXIMUM, CLIQ

Profile Cylinders

Profile Cylinder Key:

- TL – Total Length
- A – Exterior Length
- B – Interior Length
- C – Knob Length

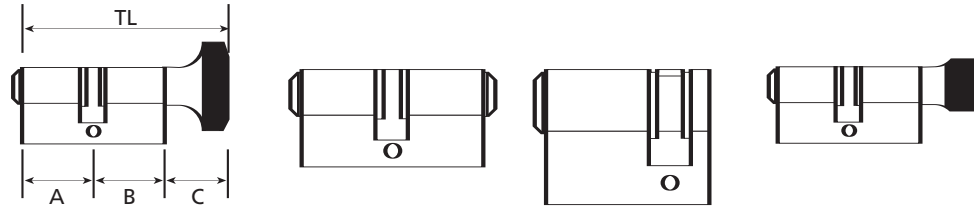

Din Euro Profile Cylinders

Model No.	Description	TL	A	B	C	Comp	Sub	SNS
Twin 6000 Classic								
6521	61mm Large Single Cyl.	3.470	1.210	1.210	1.050	106.00	95.00	89.00
6521	71mm Large Single Cyl.	3.864	1.407	1.407	1.050	106.00	95.00	89.00
6521	81mm Large Single Cyl.	4.258	1.604	1.604	1.050	106.00	95.00	89.00
6524	61mm Small Single Cyl.	3.480	1.210	1.210	1.065	105.00	94.00	87.00
6524	71mm Small Single Cyl.	3.864	1.407	1.407	1.065	105.00	94.00	87.00
6524	81mm Small Single Cyl.	4.258	1.604	1.604	1.065	105.00	94.00	87.00
6522	61mm Double Cylinder	4.420	1.210	1.210	N/A	116.00	105.00	99.00
6522	71mm Double Cylinder	2.814	1.407	1.407	N/A	116.00	105.00	99.00
6522	81mm Double Cylinder	3.208	1.604	1.604	N/A	116.00	105.00	99.00
6523	40.5mm Single Cylinder	1.571	1.203	0.368	N/A	74.00	62.00	56.00
6523	45.5mm Single Cylinder	1.768	1.400	0.368	N/A	74.00	62.00	56.00
6523	50.5mm Single Cylinder	1.965	1.597	0.368	N/A	74.00	62.00	56.00
600 Series Classic								
621	61mm Large Single Cyl.	3.470	1.210	1.210	1.050	106.00	95.00	—
621	71mm Large Single Cyl.	3.864	1.407	1.407	1.050	106.00	95.00	—
621	81mm Large Single Cyl.	4.258	1.604	1.604	1.050	106.00	95.00	—
624	61mm Small Single Cyl.	3.480	1.210	1.210	1.065	105.00	94.00	—
624	71mm Small Single Cyl.	3.864	1.407	1.407	1.065	105.00	94.00	—
624	81mm Small Single Cyl.	4.258	1.604	1.604	1.065	105.00	94.00	—
622	61mm Double Cylinder	4.420	1.210	1.210	N/A	116.00	105.00	—
622	71mm Double Cylinder	2.814	1.407	1.407	N/A	116.00	105.00	—
622	81mm Double Cylinder	3.208	1.604	1.604	N/A	116.00	105.00	—
623	40.5mm Single Cylinder	1.571	1.203	0.368	N/A	74.00	62.00	—
623	45.5mm Single Cylinder	1.768	1.400	0.368	N/A	74.00	62.00	—
623	50.5mm Single Cylinder	1.965	1.597	0.368	N/A	74.00	62.00	—

TWIN V-10, TWIN EXCLUSIVE, TWIN PRO, TWIN MAXIMUM, CLIQ

Oval Cylinders

Profile Cylinder Key:

- TL – Total Length
- A – Cylinder Length
- B – Cylinder Height
- C – Cylinder Width

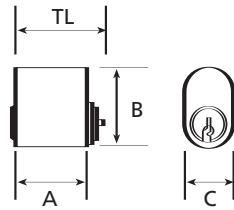

6501

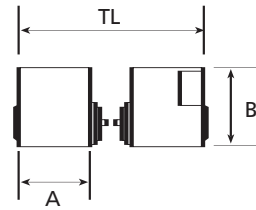

6502

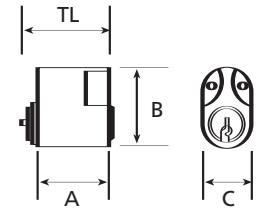

6503

Oval Cylinders

Model No.	Description	TL	A	B	C	Comp	Sub	SNS
Twin V-10								
V6501	Oval, Outside	1.577	1.236	1.376	0.784	92.00	84.50	77.00
V6501L	Oval, Outside for 505	1.577	1.236	1.376	0.784	101.00	93.00	86.00
V6502	Oval, Double	N/A	1.236	1.376	0.784	198.00	182.50	168.00
V6503	Oval, Inside	1.577	1.236	1.376	0.784	98.50	90.50	83.50
Twin Exclusive								
E6501	Oval, Outside	1.577	1.236	1.376	0.784	92.00	84.50	77.00
E6501L	Oval, Outside for 505	1.577	1.236	1.376	0.784	101.00	93.00	86.00
E6502	Oval, Double	N/A	1.236	1.376	0.784	198.00	182.50	168.00
E6503	Oval, Inside	1.577	1.236	1.376	0.784	98.50	90.50	83.50
Twin 6000 Classic								
6501	Oval, Outside	1.577	1.236	1.376	0.784	99.00	90.00	81.00
6501L	Oval, Outside for 505	1.577	1.236	1.376	0.784	109.00	99.00	91.00
6502	Oval, Double	N/A	1.236	1.376	0.784	215.00	196.00	179.00
6503	Oval, Inside	1.577	1.236	1.376	0.784	106.00	97.00	88.00
600 Series Classic								
601	Oval, Outside	1.577	1.236	1.376	0.784	99.00	90.00	—
601L	Oval, Outside for 505	1.577	1.236	1.376	0.784	109.00	99.00	—
602	Oval, Double	N/A	1.236	1.376	0.784	215.00	196.00	—
603	Oval, Inside	1.577	1.236	1.376	0.784	106.00	97.00	—

NOTE: Oval cylinders do not include cylinder rings, mounting screws or other trim.

TWIN V-10, TWIN EXCLUSIVE, TWIN PRO, TWIN MAXIMUM, CLIQ

Oval Cylinders

Profile Cylinder Key:

- TL – Total Length
- A – Cylinder Length
- B – Cylinder Height
- C – Cylinder Width

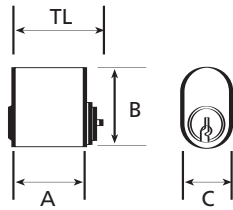

6501

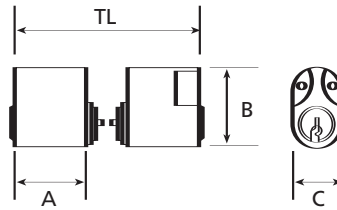

6502

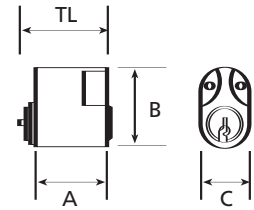

6503

Oval Cylinder Parts

Model No.	Description	Price
Twin V-10		
867064	Oval Cyl. Housing, Outside	23.00
867110	Oval Cyl. Housing, Inside	37.50
353969	Oval Cylinder Plug	27.00
Twin Exclusive/6000 Classic		
867064	Oval Cyl. Housing, Outside	23.00
867110	Oval Cyl. Housing, Inside	37.50
367018	Oval Cylinder Plug (Specify Profile)	27.00

Oval Cylinder Adapters

ASSA cylinder adapters allow the use of the Schlage KIK/KIL cylinder with ASSA mortise locks without having to replace existing master key system.

Model No.	Description	Price
803170	Oval Outside Cylinder Adapter, for Schlage KIK/KIL Cylinder	59.00
803171	Oval Inside Cylinder Adapter, for Schlage KIK/KIL Cylinder	59.00
804215	Schlage Adapter Tailpiece (Will fit 505 function)	9.00

TWIN V-10, TWIN EXCLUSIVE, TWIN PRO, TWIN MAXIMUM, CLIQ

Pin Kits, Tools & Accessories

ASSA provides all the necessary tools for both the retail and institutional locksmith to service and maintain our locks in the field. We offer several sizes of pinning kits from large, full service kits designed for the shop environment to smaller, convenient kits appropriate for service calls. Also available are high quality key cutting equipment, all approved ASSA cylinder lubricants, and various state-of-the-art key management and master key software programs for both single site and network applications.

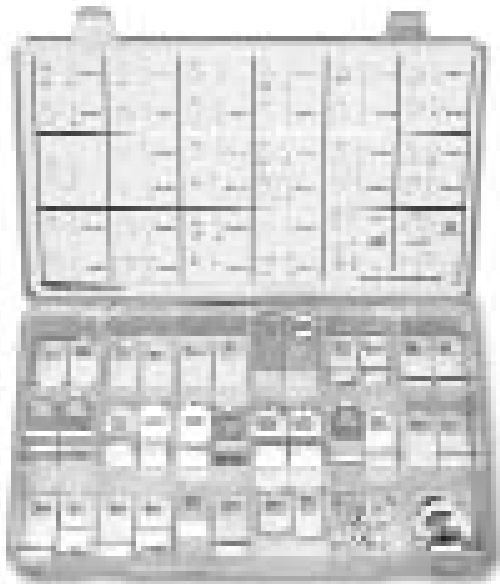

TWIN V-10, TWIN EXCLUSIVE, TWIN PRO, TWIN MAXIMUM, CLIQ

Interchangeable Core Parts

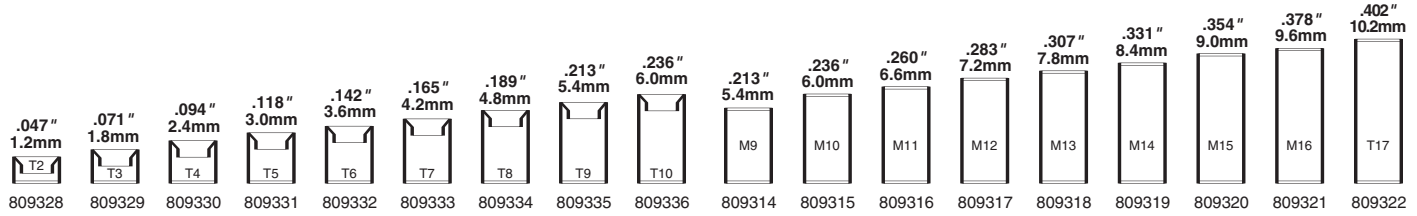

Interchangeable Core Parts

Model No.	Description	Price
354023	Control Sleeve	32.50
353213	IC Inner Plug*	30.00
353968	V-10 IC Inner Plug*	22.50
807401	IC C-Ring	.50
807402	IC Cover Slide	1.00
807403	IC Cam Adapter	22.00
807404	IC Wave Washer	1.00
807405	IC Rubber Stop	1.25
810695	IC Core (Figure-8) Housing*	49.50
807411	IC Mortise/Rim Housing*	55.00
809340	IC Cylinder Springs (1st Four Chambers)	20.00/c
809312	IC Plug Spacer Washer	.75

Top Pins For Interchangeable Core Cylinders Only

Model No.	Description	Package Quantity	Price
809328	Top Pin #2	100	21.00/c
809329	Top Pin #3	100	21.00/c
809330	Top Pin #4	100	21.00/c
809331	Top Pin #5	100	21.00/c
809332	Top Pin #6	100	21.00/c
809333	Top Pin #7	100	21.00/c
809334	Top Pin #8	100	21.00/c
809335	Top Pin #9	100	21.00/c
809336	Top Pin #10	100	21.00/c

Master Pins For Interchangeable Core Cylinders Only

Model No.	Description	Package Quantity	Price
809314	Master Pin #9	100	21.00/c
809315	Master Pin #10	100	21.00/c
809316	Master Pin #11	100	21.00/c
809317	Master Pin #12	100	21.00/c
809318	Master Pin #13	100	21.00/c
809319	Master Pin #14	100	21.00/c
809320	Master Pin #15	100	21.00/c
809321	Master Pin #16	100	21.00/c
809322	Master Pin #17	100	21.00/c

*Indicate product finish.

TWIN V-10, TWIN EXCLUSIVE, TWIN PRO, TWIN MAXIMUM, CLIQ

Pins, Springs & Closers

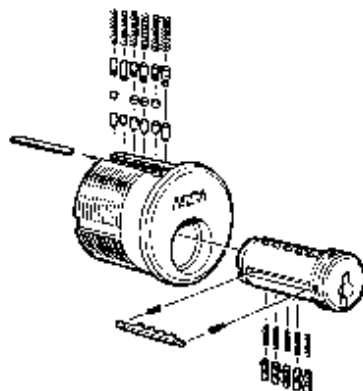

Pins, Springs & Closers

Model No.	Description	Package Quantity	Price
867066/807261	Driver Pin 1-2	100	25.00/c
867067/807262	Driver Pin 3-4	100	25.00/c
867068/807263	Driver Pin 5-6	100	25.00/c
867069/807264	Driver Pin 7-8-9	100	25.00/c
867070	Master Pin 1	100	25.00/c
867071	Master Pin 2	100	25.00/c
867072	Master Pin 3	100	25.00/c
867073	Master Pin 4	100	25.00/c
867074	Master Pin 5	100	25.00/c
867075	Master Pin 6	100	25.00/c
867076	Master Pin 7	100	25.00/c
867077	Master Pin 8	100	25.00/c
867078	Bottom Pin 1	100	25.00/c
867079	Bottom Pin 2	100	25.00/c
867080	Bottom Pin 3	100	25.00/c
867081	Bottom Pin 4	100	25.00/c
867082	Bottom Pin 5	100	25.00/c
867083	Bottom Pin 6	100	25.00/c
867084	Bottom Pin 7	100	25.00/c
867085	Bottom Pin 8	100	25.00/c
867086	Bottom Pin 9	100	25.00/c
867065	Cylinder Springs	100	25.00/c
*267008	V-10, Twin 6000, & Twin Exclusive Sidebar	25	7.50/ea
867015	Twin Side Pins	50	44.50/c
353838	V-10 Left Hand Side Pins	50	44.50/c
816080	Twin Pro Side Pins	100	90.00/c
807164	V-10/Twin Pro Sidebar Springs	100	14.00/c
807165	V-10/Twin Pro Sidepin Springs	100	14.00/c
867087	Twin Sidepin Springs	100	14.00/c
867088	Twin Sidebar Springs	100	14.00/c
868141	Pin Chamber Closing Strips, Mort, Rim, KIK	100	52.00/c
867093	Closing Plugs, Oval Cylinders	100	56.00/c
806346	Pin Chamber Closing Screws - Jumbo, Mogul, Dbolt	100	56.00/c

*Specify Code

TWIN V-10, TWIN EXCLUSIVE, TWIN PRO

Cams & Tailpieces

Cam Key:

R-A – Head Radius • R-B – Overall Radius

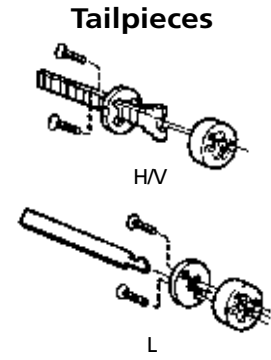
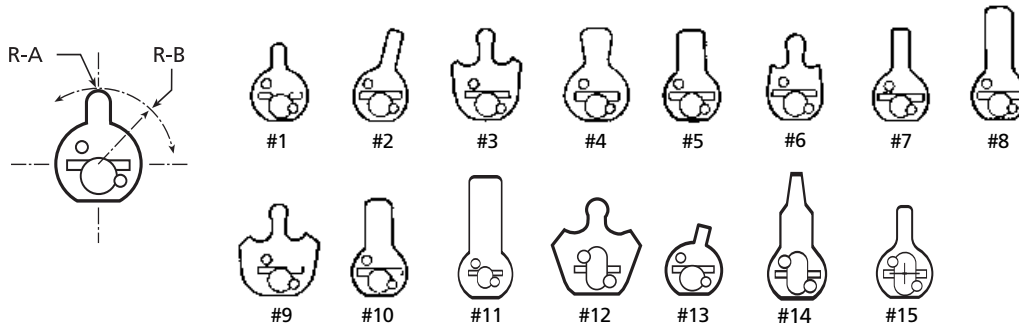

Cams & Tailpieces

Model #	Description	R-A	R-B	Package Qty.	Price
867445	#1 Adams Rite Cam	0.118	0.555	10	4.50/ea
867452	#2 Sargent Cam	N/A	0.709	10	4.50/ea
867446	#3 Corbin Clover Leaf Cam	0.114	0.602	10	4.50/ea
867447	#4 Corbin Beaver Tail Cam	N/A	0.732	10	4.50/ea
872610	#5 Yale/Standard Cam	N/A	0.709	10	4.50/ea
867453	#6 Schlage "L" Cam	0.124	0.516	10	10.50/ea
805412	#7 Segal Type Cam	N/A	0.779	10	10.50/ea
806471	#8 Jumbo Corbin Cam	N/A	0.914	10	10.50/ea
907306	#9 Best 30H Series	0.114	0.602	10	10.50/ea
353445	#10 Airteq/Norment Cam	N/A	0.787	10	5.00/ea
809337	#11 Airteq/Norment Mogul Cam	N/A	1.165	10	10.50/ea
354945	#12 Corbin Jumbo Clover Leaf Cam	0.114	0.828	10	10.50/ea
355849	#13 Sargent Short Cam	N/A	0.515	10	10.50/ea
355850	#14 Sargent Mogul	N/A	1.043	10	10.50/ea
872612	#15 Yale Replacement Cam	0.742	0.308	10	10.50/ea
867450	Horizontal & Vertical Rim Tailpiece kit				16.50/ea
867451	Lazy-motion Rim Tailpiece kit				16.50/ea
868958	Schlage KIK Plug Cap			10	2.25/ea
868959	Schlage KIK Plug Cap Spring			100	.50/ea
868960	Schlage KIK Plug Cap Pin			100	.25/ea
804877	Schlage Break-off Tailpiece			10	4.25/ea
868654	Corbin New Style Standard-duty Tailpiece			100	2.00/ea
868624	Rollpin - Corbin			10	.25/ea
868231	Cylinder Plug Retaining Ring			100	.50/ea
900250	Sargent 6-line, Arrow Tailpiece (short)				2.25/ea
900251	Sargent 6-line, Arrow Tailpiece (long)				2.25/ea
900252	Sargent 6-line, Arrow Tailpiece retaining ring				.50/ea
900253	Sargent/Arrow Tailpiece (Med.)				1.75/ea
900254	Sargent 11-line T-Zone Tailpiece				4.25/ea
900256	Yale Key-In-Lever Tailpiece				6.00/ea
900257	Yale Key-In-Lever Roll Pin				2.00/ea
867045	Oval Cylinder Tailpiece			50	3.00/ea
803169	Oval Cylinder Tailpiece, 505 Lock Function				7.50
867046	Tailpiece Washer			50	3.50/ea
867090	Phillips Screws for Cams, Mortise & Oval Tailpiece			100	1.00/ea
868138	Slotted Screws for Rim Tailpiece			100	.75/ea
868134	Tail Extension for Rim Cylinder				8.00
867109	Break-off Tailpiece for V/H Rim Cylinder				6.00
868136	Lazy Motion Tailpiece for Rim Cylinder				5.75
868135	Lazy Motion Tailpiece Washer				3.50

TWIN V-10, TWIN EXCLUSIVE, TWIN PRO

Pin Kits & Tools

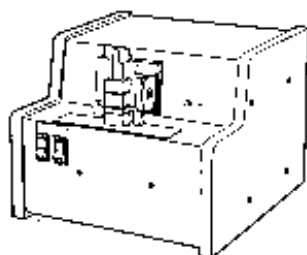
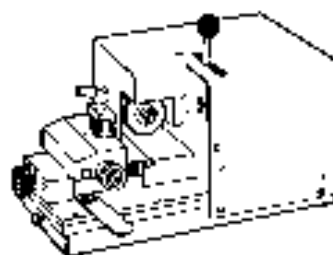
Automatic Code Machine
PS6000APositive Stop Code Machine
PS6000T

Pin Kits & Tools

Model No.	Description	Price
PK-1	Pin Kit No.1 Full-Size Standard Kit for Twin	647.00
PK-4	Pin Kit No.4 Mini Pin Kit for Twin	273.50
PK-IC	Pin Kit-Interchangeable Core Upgrade	587.00
PK-MM	Micro Mini Pin Kit	141.00
PK-CAM	PK Cam Lock Upgrade	96.00
MPK	Master Pinning Kit Twin & IC	1,153.50
MKP	Master Key Program	932.00
MKP2000/XP	Master Key Program 2000/XP	932.00
MKSV	ASSA Master Key System Viewer	786.00
KWZ-S*	Key Wizard Key Records Mgmt. Software Single Sight Version	825.00
KWZ-N*	Key Wizard Key Records Mgmt. Software Network Version	995.00
KWZ-D	Key Wizard Key Records Mgmt. Software Working Demo	Contact your local ASSA Rep.
KWZ-I*	Key Wizard Import File for ASSA System	274.00
869018	Twin & V-10 Cutter Wheel for HPC 1200 CM90°/.032"	360.50
869017	Twin & V-10 Framon Cutter Wheel	297.50
867056	Cutter Wheel for PS-7000R	418.00
KXASDC	Depth Cam for KX-1 ASSA	121.50
KXASSC	Space Cam for KX-1 ASSA	121.50
KXAS01	Cam Set for KX-1	244.00
KXAS02	Cam Set Plus Vise	421.00
KXAS03	Cam Set Plus Cutter	547.00
KXAS04	Cam Set (Cutter Vise)	724.00
F2SH050A	ASSA Vise	191.50
969020	Twin & V-10 Code Card for HPC 1200CM	33.50
807718	ASSA Lock Spray Petroleum Lubricant	14.00/ea
816296	ASSA Lock Spray Cleaner/De-Icer	14.00/ea
802631	ASSA Lock Spray Dry Film Lubricant	14.00/ea
P872630	ASSA Twin Pro Mortise Cylinder Cutaway	159.00
V872630	ASSA Twin V-10 Mortise Cylinder Cutaway	159.00
PS-6000T	Positive Stop Code Key Machine	4,892.50
PS-6000A	Automatic Code Machine (Computer required, not supplied)	12,566.00
907200	PK-1 Pin Kit Box Only	131.00
907205	PK-IC Pin Kit Box IC Only	131.00
907206	MPK Pin Kit Box Only	171.00
907207	Micro Mini Pin Kit Box Only	56.50
907208	Pin Kit Cam Lock Upgrade Box Only	53.00
907009	Clear Deadbolt Mounting Ring	14.00
SGTRCTOOL	Shearing Tool for Sargent style Interchangeable Core	275.00

* Key wizard software is invoiced at Book Net.

TWIN V-10, TWIN EXCLUSIVE, TWIN PRO, TWIN MAXIMUM, CLIQ

Care & Maintenance for ASSA Cylinders & Keys

ASSA products are the highest quality cylinder products on the market today. The following information for maintaining proper condition of your ASSA cylinders and keys will insure the best performance for you and your clients.

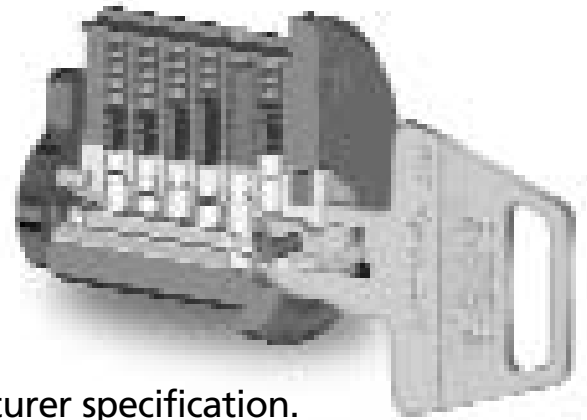

Make sure that all key cutting equipment is properly calibrated in accordance to ASSA manufacturer specification. This is the first consideration in the proper performance of ASSA cylinders. Periodically inspect keys in use and replace any keys that show physical wear.

ASSA cylinders are a mechanical device and like any mechanical device they need regular preventive maintenance. At the time of installation cylinders must be lubricated with ASSA approved lubricant. Wipe off any excess lubricant on exposed surfaces. Cleaning and lubricating the lock mechanism that the ASSA cylinder is being installed into is important as well. ASSA cylinders should be lubricated at least twice a year as normal maintenance.

- **Do not use graphite or silicone lubricants. Use only ASSA approved lubricants.**
- **Do not expose ASSA cylinders to chemical wash.**
- **Do not paint any cylinder surfaces.**

Do not over lubricate ASSA cylinders. If you suspect cylinder has been over lubricated or suspect excessive dirt or other particles or debris, thoroughly flush with ASSA cleaner deicer or use an alcohol base electrical contact cleaner. Let dry or dry with compressed air then re-lubricate with ASSA approved lubricant.

As part of the ASSA 5-Way Guarantee

- **ASSA will replace any key that breaks under normal use for life.**
- **ASSA will warranty any ASSA cylinder against manufacture defect for life.**

TWIN V-10, TWIN EXCLUSIVE, TWIN PRO, TWIN MAXIMUM, CLIQ

Servicing ASSA Cam Locks

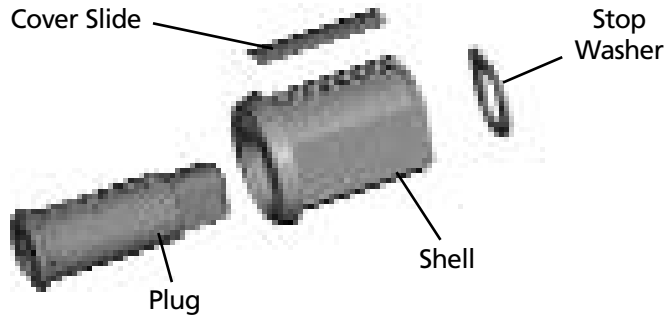

Key Retained

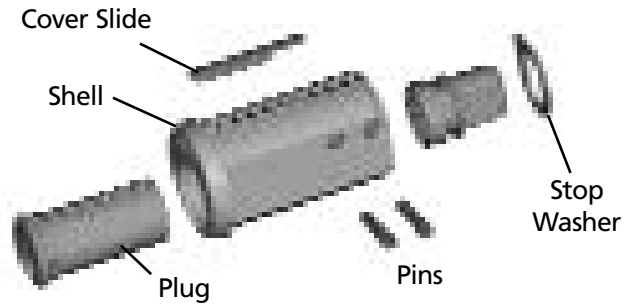

Non-Key Retained

ASSA cam locks are serviced with standard Twin bottom and master pins. The tops pins, or drives and springs used in ASSA cam locks are the hollowed top pins used in the ASSA Interchangeable Core product T-2 through T-9. The top pin used in each chamber is equal to the total operating stack. A #7 bottom pin uses a T-7 top pin. For master keying a #5 bottom pin – a #3 master pin equals a total operating stack of 2. The T-2 top pin is used. Due to stack height restrictions the #1 depth of cut can not be used in ASSA cam locks.

- Top Pin #2 – 809328
- Top Pin #3 – 809329
- Top Pin #4 – 809330
- Top Pin #5 – 809331
- Top Pin #6 – 809332
- Top Pin #7 – 809333
- Top Pin #8 – 809334
- Top Pin #9 – 809335
- Chamber spring – 809335

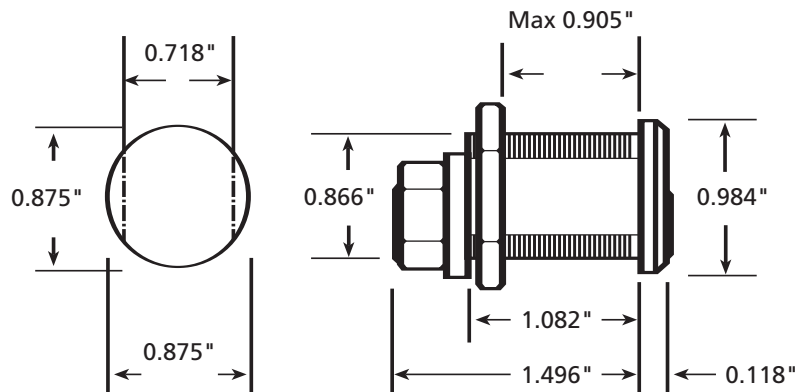
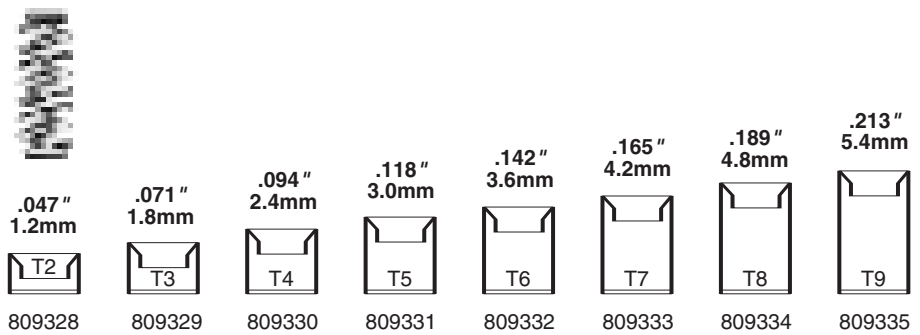

For metal installation use 7/8" double D punch.

TWIN V-10, TWIN EXCLUSIVE, TWIN PRO, TWIN MAXIMUM, CLIQ

Component Parts Index

Model No.	Description	Page Number
250619	Arrow Cylinder Shell	83, 84
250861	1-1/8" Mogul Cylinder Plug	42, 48
250894	1-1/2" Mogul Cylinder Plug	43, 48
267008	V-10, Twin 6000, & Twin Exclusive Sidebar	42, 43, 133
352323	Outside Cylinder Shell	92
352324	Inside Cylinder Shell	92
352325	Thumbturn Housing Only	92
352326	Thumbturn	92
353213	IC Inner Plug	132
353445	#10 Airteq/Norment Cam	134
353787	Russwin/Corbin 25F65 Cylinder Plug	83
353838	V-10 Left Hand Side Pins	133
353968	V-10 IC Inner Plug	132
353969	Twin V-10 Cylinder Plug	92, 120, 130
353970	1-1/8" Cylinder Plug	38, 56
353971	1-1/4" Cylinder Plug	38
353972	1-3/8" Cylinder Plug	38
353973	1-1/2" Cylinder Plug	38
353974	1-5/8" Cylinder Plug	38
353975	1-3/4" Cylinder Plug	38
353976	1-7/8" Cylinder Plug	38
353977	2" Cylinder Plug	38
353978	Schlage Cylinder Plug	83
353979	Yale Cylinder Plug – (Must specify KIK or KIL).	83
353980	Sargent Integra Cylinder Plug	83
353981	Sargent Heavy-Duty 7, 8, 9 Cylinder Plug	83
353982	Falcon S & X Series/Weiser Deadbolt Plug	83
353983	Arrow/Sargent 6-line Cylinder Plug	83
353984	Russwin/Corbin std. & Heavy-Duty Cylinder Plug	83
353985	Russwin/Corbin 19F35 Cylinder Plug	83
353986	Corbin 25F26 Cylinder Plug	83
354023	Control Sleeve	132
354051	1-1/8" Mogul Cylinder Shell	42, 48
354945	#12 Corbin Jumbo Clover Leaf Cam	134
354993	Cam Adaptor for 1-1/2" Cylinder	43, 48
355849	#13 Sargent Short Cam	134
355850	#14 Sargent Mogul	134
356071	Twin Plug (for profiles 51 & 851)	92
356955	1-1/8" Cylinder Plug	39, 56
356956	1-1/4" Cylinder Plug	39
356957	1-3/8" Cylinder Plug	39
356958	1-1/2" Cylinder Plug	39
356959	1-5/8" Cylinder Plug	39
356960	1-3/4" Cylinder Plug	39
356961	1-7/8" Cylinder Plug	39
356962	2" Cylinder Plug	39

TWIN V-10, TWIN EXCLUSIVE, TWIN PRO, TWIN MAXIMUM, CLIQ

Component Parts Index

Model No.	Description	Page Number
356982	Schlage Cylinder Plug	84
356983	Yale Cylinder Plug – (Must specify KIK or KIL).	84
356984	Russwin/Corbin std. & Heavy-Duty Cylinder Plug	84
356985	Russwin/Corbin 19F35 Cylinder Plug	84
356986	Corbin 25F26 Cylinder Plug	84
356987	Russwin/Corbin 25F65 Cylinder Plug	84
356988	Sargent Integra Cylinder Plug	84
356989	Sargent Heavy-Duty 7, 8, 9 Cylinder Plug	84
356990	Arrow/Sargent 6-line Cylinder Plug	84
357672	1-1/2" Mogul Cylinder Shell	43, 48
367018	Twin Exclusive Cylinder Plug	120, 130
367019	1-1/8" Cylinder Plug	38, 56
367020	1-1/4" Cylinder Plug	38
367021	1-3/8" Cylinder Plug	38
367022	1-1/2" Cylinder Plug	38
367023	1-5/8" Cylinder Plug	38
367024	1-3/4" Cylinder Plug	38
367025	1-7/8" Cylinder Plug	38
367026	2" Cylinder Plug	38
367068	Schlage Cylinder Plug	83
367069	Yale Cylinder Plug – (Must specify KIK or KIL).	83
367073	Sargent Integra Cylinder Plug	83
367074	Sargent Heavy-Duty 7, 8, 9 Cylinder Plug	83
367156	Russwin/Corbin Cylinder Shell	83, 84
367159	Sargent Standard-duty Cylinder Shell	83, 84
390040	Cam Lock Catch	110
390041	Cam Lock Catch	110
390042	Cam Lock Catch	110
390043	Cam Lock Catch	110
390044	Cam Lock Catch	110
390045	Cam Lock Catch	110
390054	Cam Lock Catch	110
390055	Cam Lock Catch	110
390056	Cam Lock Catch	110
390058	Cam Lock Catch	110
390061	Cam Lock Catch	110
390062	Cam Lock Catch	110
390068	Cam Lock Catch	110
390069	Cam Lock Catch	110
390070	Cam Lock Catch	110
391053	Cam Lock dust cap	111
442774	Deadbolt Bolt Faceplate	92
453978	Arrow Deadbolt Plug	83
467068	Arrow Deadbolt Plug	83
490246	Cam Lock washer	111
490271	Cam Lock cylinder ring	111

TWIN V-10, TWIN EXCLUSIVE, TWIN PRO, TWIN MAXIMUM, CLIQ

Component Parts Index

Model No.	Description	Page Number
490583	Cam Lock nut	111
490610	Cam Lock housing nut (m22x1)	111
490657	Cam Lock front plate	111
490663	Cam Lock housing washer	111
490800	Cam Lock Catch	110
490821	Cam Lock front plate	111
490825	Cam Lock fixing plate	111
490827	Cam Lock Catch	110
490842	Cam Lock Catch	110
490847	Cam Lock Catch	110
490880	Cam Lock Catch	110
490890	Cam Lock Catch	110
490907	Cam Lock Catch	110
490926	Cam Lock Catch	110
490963	Cam Lock Catch	110
490972	Cam Lock Catch	110
490973	Cam Lock Catch	110
491210	Cam Lock Catch	110
491221	Cam Lock Catch	110
491299	Cam Lock nail plate	111
491317	Cam Lock Catch	110
491331	Cam Lock Catch	110
491439	Cam Lock nut (m11x1)	111
491449	Cam Lock fixing plate	111
491450	Cam Lock front plate	111
491498	Cam Lock Catch	110
497008	Cam Lock front plate	111
803169	Oval Cylinder Tailpiece, 505 Lock Function	134
803170	Oval Outside Cylinder Adapter, for Schlage KIK/KIL Cylinder	130
803171	Oval Inside Cylinder Adapter, for Schlage KIK/KIL Cylinder	130
803575	No.3 Locking Ball Bearings	120
803607	No.2 Locking Balls	120
804215	Schlage Adapter Tailpiece (Will fit 505 function)	130
804877	Schlage Break-off Tailpiece	134
805412	#7 Segal Type Cam	134
806256	IC Cylinder and Thumbturn Cap	92
806262	Tailpiece	92
806263	Thumbturn Tailpiece bushing	92
806265	Thumbturn Spindle	92
806266	Cylinder Thumbturn Cap	92
806267	Cylinder Ring	92
806268	Spacer Ring 1-3/8" Door	92
806269	Adapter Ring 2-1/8" Side Hole	92
806270	Thumbturn Ring	92
806346	Pin Chamber Closing Screws - Jumbo, Mogul, Dbolt	42, 43, 92, 133
806471	#8 Jumbo Corbin Cam	134

TWIN V-10, TWIN EXCLUSIVE, TWIN PRO, TWIN MAXIMUM, CLIQ

Component Parts Index

Model No.	Description	Page Number
806483	Thumbturn Set Screws	92
806898	No.2 Regular Shackle	120
806910	No.3 Padlock Shackle	120
806911	No.3 Blocking Pin	120
806913	No.3 Cylinder Retaining Screw	120
807164	V-10/Twin Pro Sidebar Springs	133
807165	V-10/Twin Pro Sidepin Springs	133
807217	No.2 Extended Shackle	120
807401	IC C-Ring	132
807402	IC Cover Slide	132
807403	IC Cam Adapter	132
807404	IC Wave Washer	132
807405	IC Rubber Stop	132
807411	IC Mortise/Rim Housing	132
807987	Corbin Jumbo 1-1/8" Shell	38, 39, 56
809312	IC Plug Spacer Washer	132
809314	Master Pin #9	132
809315	Master Pin #10	132
809316	Master Pin #11	132
809317	Master Pin #12	132
809318	Master Pin #13	132
809319	Master Pin #14	132
809320	Master Pin #15	132
809321	Master Pin #16	132
809322	Master Pin #17	132
809328	Top Pin #2	132, 137
809329	Top Pin #3	132, 137
809330	Top Pin #4	132, 137
809331	Top Pin #5	132, 137
809332	Top Pin #6	132, 137
809333	Top Pin #7	132, 137
809334	Top Pin #8	132, 137
809335	Top Pin #9	132, 137
809336	Top Pin #10	132
809337	#11 Airteq/Norment Mogul Cam	42, 134
809339	Mogul Cylinder Plug Cover Plate	42, 43, 48
809340	IC Cylinder Springs (1st Four Chambers)	132
809387	No.2 Key-Retaining Blocking pin	120
809388	No.2 Non-Key-Retaining Blocking Pin/Spring/Tailpiece	120
810695	IC Core (Figure-8) Housing	132
816068	Twin Pro Cylinder Plug	92
816080	Twin Pro Side Pins	133
867015	Twin Side Pins	42, 43, 133
867045	Oval Cylinder Tailpiece	134
867046	Tailpiece Washer	92, 120, 134
867064	Oval Cyl. Housing, Outside	130
867065	Cylinder Springs	133
867070	Master Pin 1	133, 143

TWIN V-10, TWIN EXCLUSIVE, TWIN PRO, TWIN MAXIMUM, CLIQ

Component Parts Index

Model No.	Description	Page Number
867071	Master Pin 2	133, 143
867072	Master Pin 3	133, 143
867073	Master Pin 4	133, 143
867074	Master Pin 5	133, 143
867075	Master Pin 6	133, 143
867076	Master Pin 7	133, 143
867077	Master Pin 8	133, 143
867078	Bottom Pin 1	133, 143
867079	Bottom Pin 2	133, 143
867080	Bottom Pin 3	133, 143
867081	Bottom Pin 4	133, 143
867082	Bottom Pin 5	133, 143
867083	Bottom Pin 6	133, 143
867084	Bottom Pin 7	133, 143
867085	Bottom Pin 8	133, 143
867086	Bottom Pin 9	133, 143
867087	Twin Sidepin Springs	133
867088	Twin Sidebar Springs	133
867090	Phillips Screws for Cams, Mortise & Oval Tailpiece	42, 43, 92, 134
867093	Closing Plugs, Oval Cylinders	13
867109	V/H Rim Cylinder Break-off Tailpiece for Special Door Thickness	92, 134
867110	Oval Cyl. Housing, Inside	130
867429	1-1/8" Cylinder Shell	38, 39, 56
867431	1-3/8" Cylinder Shell	38, 39
867432	1-1/2" Cylinder Shell	38, 39
867433	1-5/8" Cylinder Shell	38, 39
867434	1-3/4" Cylinder Shell	38, 39
867435	1-7/8" Cylinder Shell	38, 39
867436	2" Cylinder Shell	38, 39
867445	#1 Adams Rite Cam	134
867446	#3 Corbin Clover Leaf Cam	134
867447	#4 Corbin Beaver Tail Cam	134
867450	Horizontal & Vertical Rim Tailpiece kit	50, 134
867451	Lazy-motion Rim Tailpiece kit	50, 134
867452	#2 Sargent Cam	134
867453	#6 Schlage "L" Cam	134
868056	Schlage Cylinder Shell	83, 84
868057	Yale Cylinder Shell	83, 84
868060	Sargent Integra Cylinder Shell	83, 84
868061	Sargent Heavy-duty Cylinder Shell	83, 84
868134	Tail Extension for Rim Cylinder	134
868135	Lazy Motion Tailpiece Washer	134
868136	Lazy Motion Tailpiece for Rim Cylinder	134
868138	Slotted Screws for Rim Tailpiece	134
868141	Pin Chamber Closing Strips, Mort, Rim, KIK	133
868231	Cylinder Plug Retaining Ring	134
868233	Falcon S & X Series/Weiser Deadbolt Plug	83
868607	Arrow/Sargent 6-line Cylinder Plug	83

TWIN V-10, TWIN EXCLUSIVE, TWIN PRO, TWIN MAXIMUM, CLIQ

Component Parts Index

Model No.	Description	Page Number
868624	Rollpin - Corbin	134
868649	Russwin/Corbin std. & Heavy-Duty Cylinder Plug	83
868650	Russwin/Corbin 19F35 Cylinder Plug	83
868651	Corbin 25F26 Cylinder Plug	83
868652	Russwin/Corbin 25F65 Cylinder Plug	83
868654	Corbin New Style Standard-duty Tailpiece	134
868958	Schlage KIK Plug Cap	134
868959	Schlage KIK Plug Cap Spring	134
868960	Schlage KIK Plug Cap Pin	134
872610	#5 Yale/Standard Cam	134
872612	#15 Yale Replacement Cam	134
900250	Sargent 6-line, Arrow Tailpiece (short)	134
900251	Sargent 6-line, Arrow Tailpiece (long)	134
900252	Sargent 6-line, Arrow Tailpiece retaining ring	134
900253	Sargent/Arrow Tailpiece (Med.)	134
900254	Sargent 11-line T-Zone Tailpiece	134
900256	Yale Key-In-Lever Tailpiece	134
900257	Yale Key-In-Lever Roll Pin	134
907001	2-3/4" Faceplate Bolt	92
907002	2-3/4" Drive-In Bolt	92
907003	2-3/8" Faceplate Bolt	92
907004	2-3/8" Drive-In Bolt	92
907005	Strike Plate with Screws	92
907007	Reinforced Strike Box and Screws	92
907008	Security Bolt Guard Plate	92
907010	Deadbolt Mounting Bolts (Std. Single Cyl.)	92
907011	Deadbolt Mounting Bolts (Std. Double cyl.)	92
907012	Deadbolt mounting Bolts (3")	92
907013	Deadbolt Mounting Bolts (3-1/4")	92
907015	Security Balls for Single & Double Cylinder	92
907016	Deadbolt Strike Box Screw	92
907035	Mogul Chamber Screw Wrench	48
907035	Deadbolt Chamber Screw Wrench	92
907050	Corbin Jumbo Cylinder Thread Adapter	38
907203	Arrow Deadbolt/Weiser KIK Shell	83, 84
907306	#9 Best 30H Series	134
806266NT	Cylinder Cap, No Thumbturn	92
867066/807261	Driver Pin 1-2	133
867067/807262	Driver Pin 3-4	133
867068/807263	Driver Pin 5-6	133
867069/807264	Driver Pin 7-8-9	133
92C-114	Arrow Deadbolt Cap	83, 84
92C-121	Arrow Deadbolt Washer	83, 84
92C-123	Arrow Deadbolt Blocking Piece	83, 84
92C-127	Arrow Deadbolt Plug Cap Spring	83, 84
92C-128	Arrow Deadbolt Plug Cap Pin	83, 84
CLK-1	Cam Lock Catch Kit (Includes 2 ea. of 31 Cam Catches)	110
CLP-D	7/8" Double D Cam Lock/Switch Lock Punch	110

TWIN V-10, TWIN EXCLUSIVE, TWIN PRO, TWIN MAXIMUM, CLIQ

Component Parts Index

Model No.	Description	Page Number
D61-44	Arrow Deadbolt Long Tailpiece (Single Cylinder)	83, 84
D62-44	Arrow Deadbolt Short Tailpiece (Double Cylinder)	83, 84
P250517	No.2 Shackle Spring	120
P793110	No.2 Cylinder Retaining Screw	120
P793810	No.2 Tailpiece Cam Screws	120
P857300	No.2 Plate & No. 3 Plate	120

ASSA, Inc. • 110 Sargent Drive • P.O. Box 9453 • New Haven • CT 06534-0453
Phone: 800-235-7482 • Fax: 800-892-3256 • Website: www.assalock.com

The ASSA ABLOY Group is the world's leading manufacturer and supplier of locks and associated products,
dedicated to satisfying end-user needs for security, safety and convenience.